

PROCESOS DE FUNDICIÓN

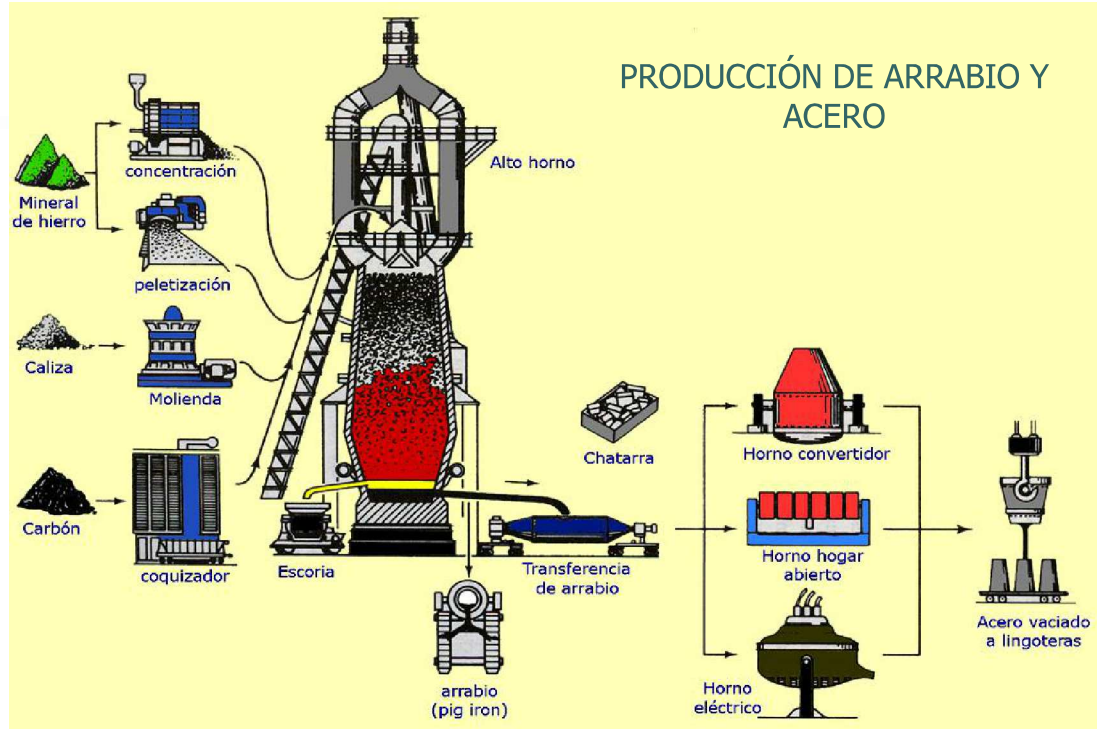



ALTO HORNO



M.Met. Francisco A. Herrera C

ALTO HORNO

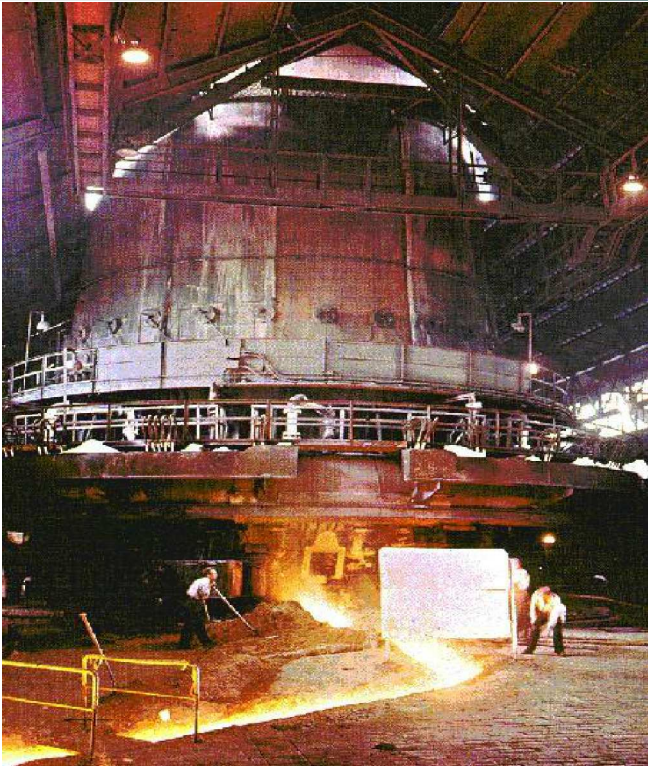

M.Met. Francisco A. Herrera C



CONVERTIDOR BESSEMER



CARGA DEL CONVERTIDOR

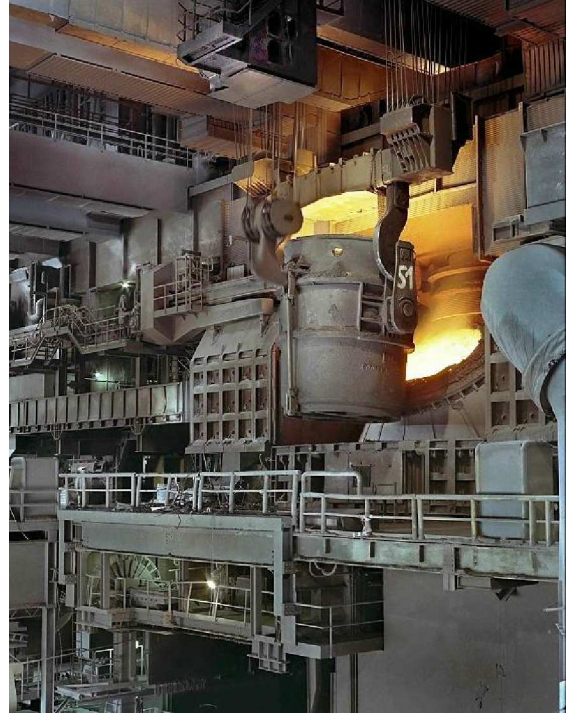

M.Met. Francisco A. Herrera C



CARGA DEL CONVERTIDOR



M.Met. Francisco A. Herrera C



CONVERTIDOR BÁSICO AL OXÍGENO (BOF)

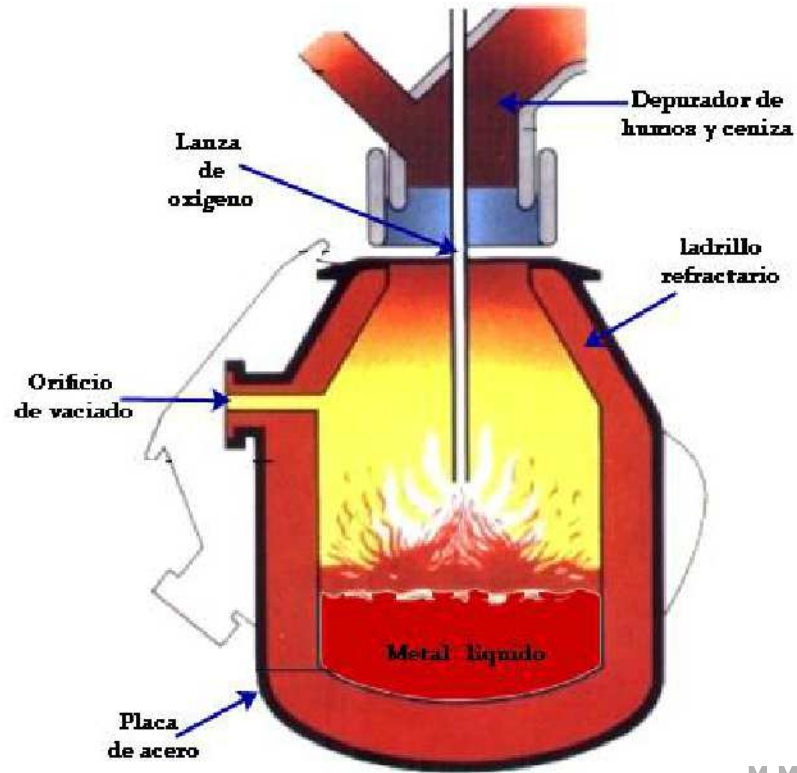

M.Met. Francisco A. Herrera C



ETAPAS DE OPERACIÓN DEL CONVERTIDOR

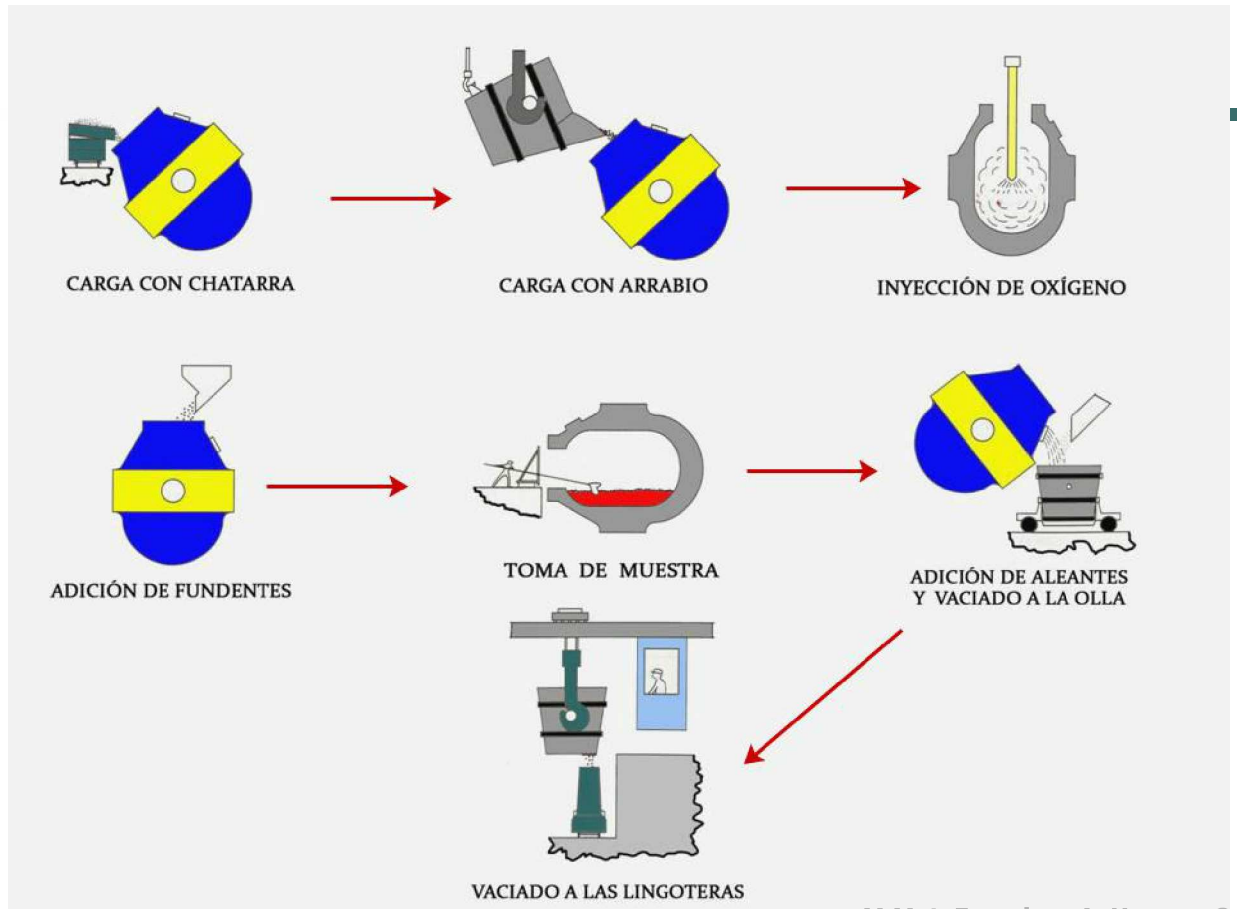

M.Met. Francisco A. Herrera C



HORNO DE ARCO ELECTRICO

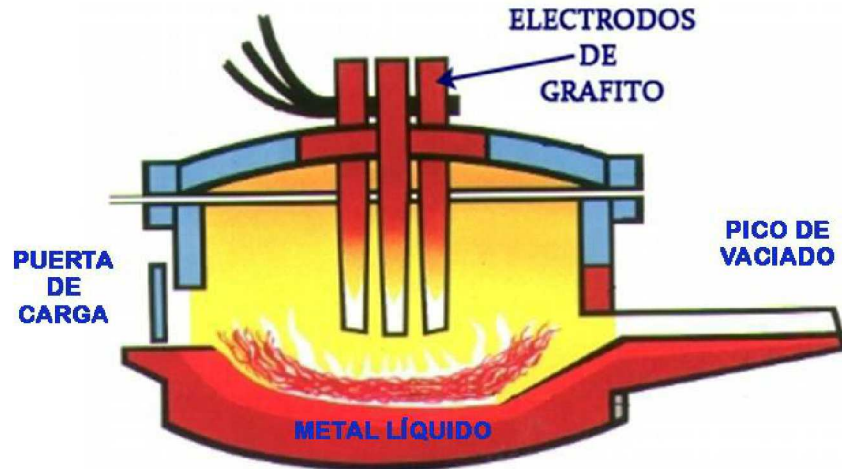

M.Met. Francisco A. Herrera C

M.Met. Francisco A. Herrera C



TIPOS DE HORNOS PARA FUNDICIÓN

Horno de crisol móvil

Horno de crisol estacionario

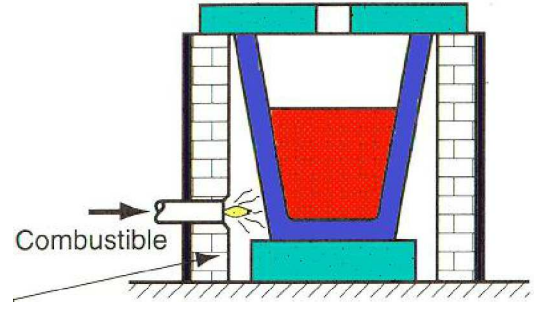
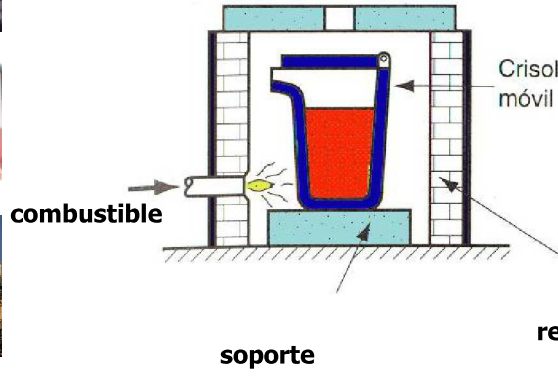

Horno de inducción

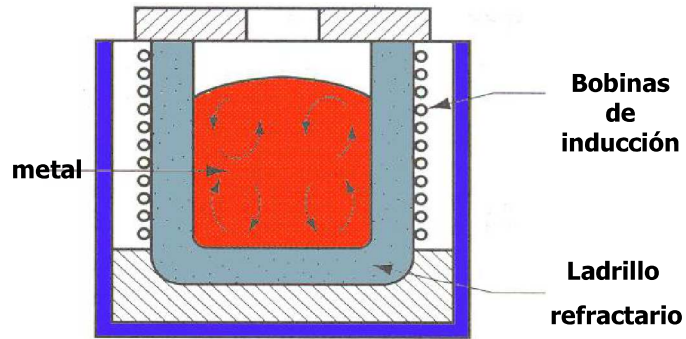



HORNO BASCULANTE

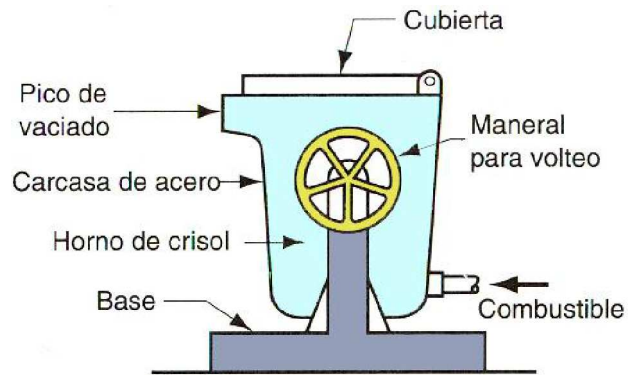

M.Met. Francisco A. Herrera C



ETAPAS EN EL PROCESO DE FUNDICIÓN DE METALES Y ALEACIONES

1.- CALENTAMIENTO Y FUSIÓN

2.- VACIADO O COLADO

3.- ENFRIAMIENTO O SOLIDIFICACIÓN

M.Met. Francisco A. Herrera C



CURVA DE ENFRIAMIENTO PARA UN METAL PURO

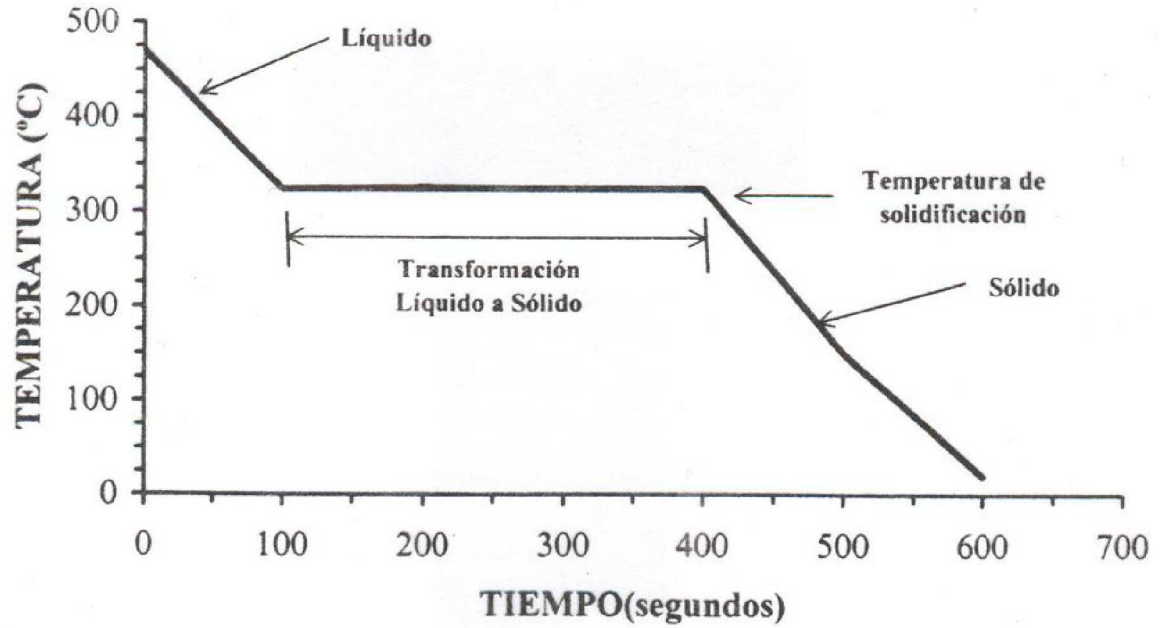

M.Met. Francisco A. Herrera C



CURVA DE ENFRIAMIENTO PARA UNA ALEACIÓN

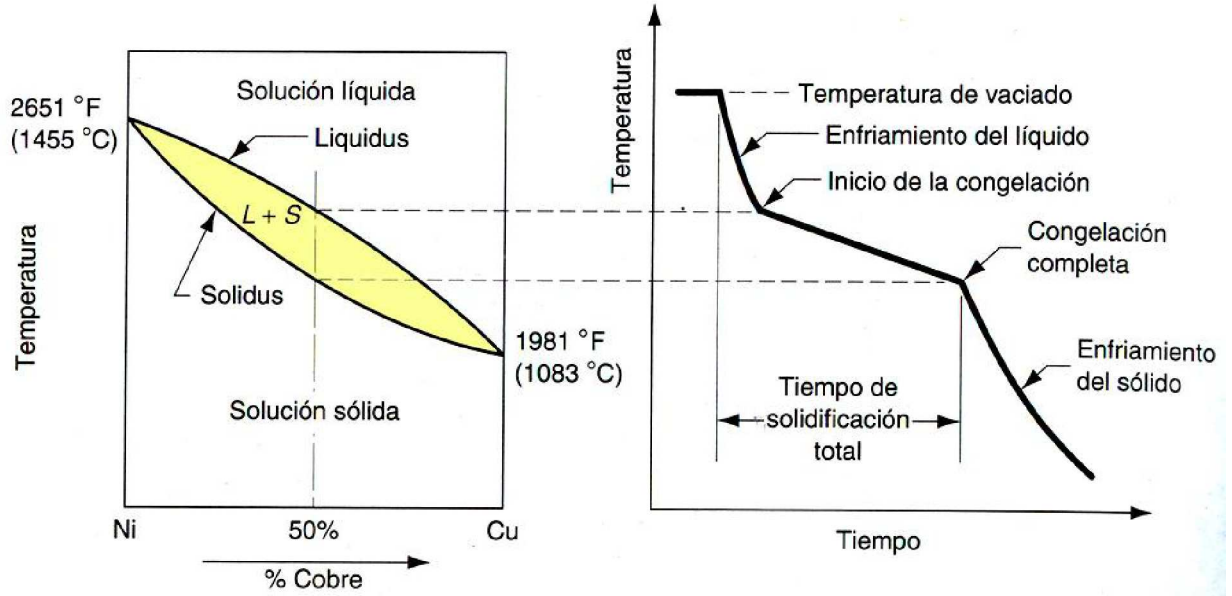

M.Met. Francisco A. Herrera C



TERMINOS COMUNES EN EL PROCESO DE FUNDICIÓN (METAL PURO)

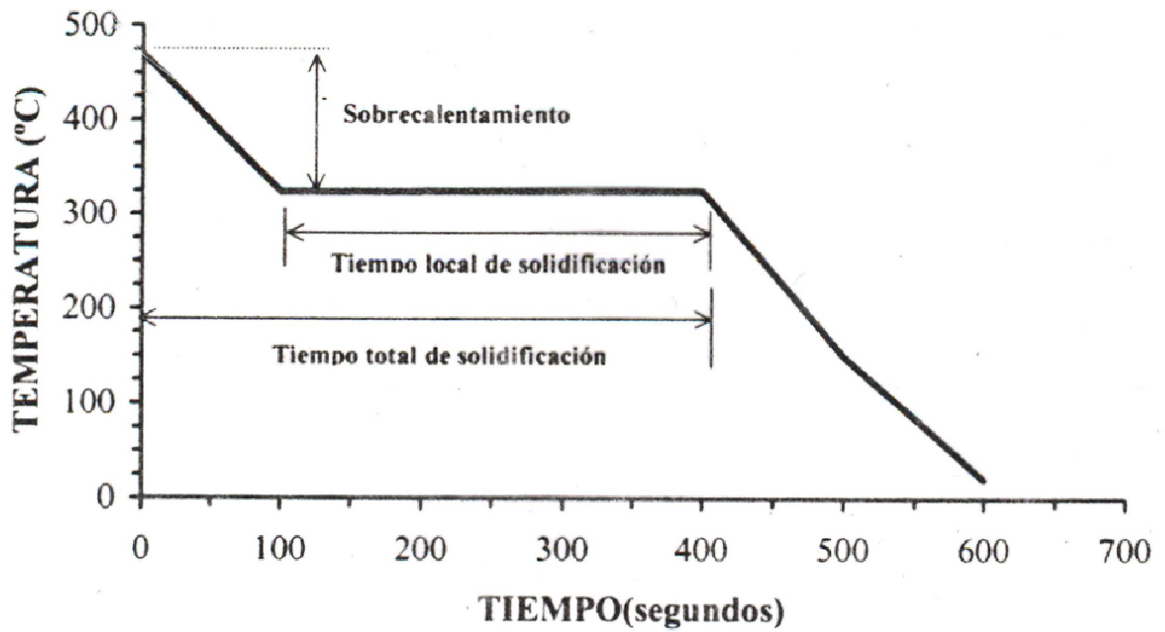



CALENTAMIENTO Y FUSIÓN DEL METAL O ALEACIÓN

La energía calorífica requerida para alcanzar la fusión completa del metal o aleación es la suma de:

- Energía calorífica para elevar la temperatura hasta el punto de fusión.
- Energía de fusión (calor latente) para convertir el metal sólido a líquido.
- Energía para elevar al metal líquido(fundido) a la temperatura de vaciado.

$$[(T_0 - T_f)C_p] + \Delta H_f + (T_v - T_f)C_l = Q$$

Donde:

Q=energía total(Joule); ρ =densidad(kg/m³); V=volumen(m³); C_{pl}=calor específico(J/kg-°C); T_f=Temp. de fusión(°C); T₀=Temperatura inicial(°C); ΔH_f =Entalpía de fusión(J/kg); T_v=Temp. de vaciado.



VACIADO O COLADO DEL METAL O ALEACIÓN



TEOREMA DE BERNOULLI

“La suma de las energías(altura, presión dinámica, energía cinética y fricción) en dos puntos cualquiera de un líquido que fluye son iguales”

$$h_1 + \frac{P_1}{g\rho} + \frac{v_1^2}{2g} + F_1 = h_2 + \frac{P_2}{g\rho} + \frac{v_2^2}{2g} + F_{1-2}$$

Donde:

h_1 = altura; P = presión; ρ = densidad; v =velocidad de flujo; g = aceleración gravitacional(386 in/s/s) o 981 cm/s/s); F = perdidas por fricción

Ignorando las pérdidas por fricción y asumiendo que el sistema permanece a presión atmosférica, la ecuación se reduce a:

$$h_1 + \frac{v_1^2}{2g} = h_2 + \frac{v_2^2}{2g}$$

M.Met. Francisco A. Herrera C



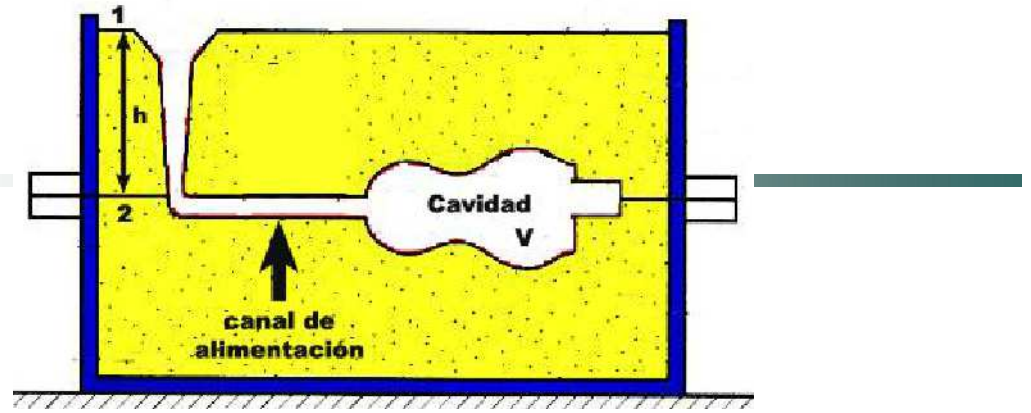

Si el punto 2 se usa como referencia, entonces la altura en ese punto es cero ($h_2 = 0$) y h_1 es la altura del bebedero. Cuando se vierte el metal líquido en la copa de vaciado y fluye hacia abajo, su velocidad inicial en la parte superior es cero ($v_1=0$).

$$h_1 = \frac{v_2^2}{2g} \quad \longrightarrow \quad v = \sqrt{2gh}$$

M.Met.
Francisco A.
Herrera C



LEY DE CONTINUIDAD

Establece que la velocidad volumétrica del flujo permanece constante a través del líquido. La velocidad del flujo volumétrico es igual a la velocidad por el área de la sección transversal del flujo líquido.

$$\dot{V} = v_1 A_1 = v_2 A_2$$

El canal de alimentación desde la base del bebedero hasta la cavidad del molde, generalmente es horizontal, por lo tanto entre estos dos puntos la altura es la misma. La velocidad volumétrica de flujo a través del sistema de alimentación y dentro de la cavidad permanece igual a vA en la base. Por consiguiente, se puede estimar el tiempo requerido para llenar la cavidad con volumen V :

$$T_{\text{llenado}} = \frac{V}{\dot{V}}$$

M.Met. Francisco A. Herrera C



MACROESTRUCTURA DE UN LINGOTE

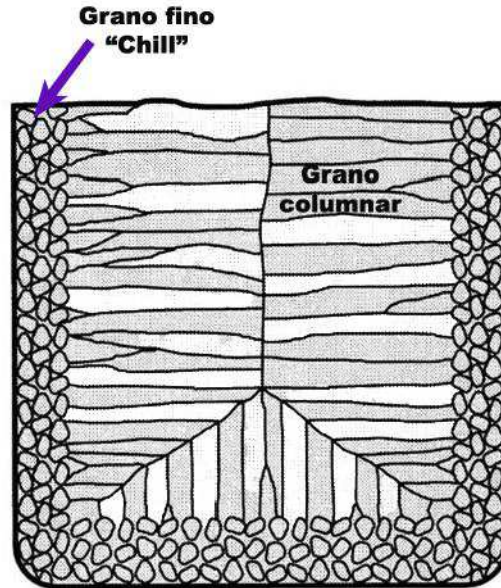

Enfriamiento rápido

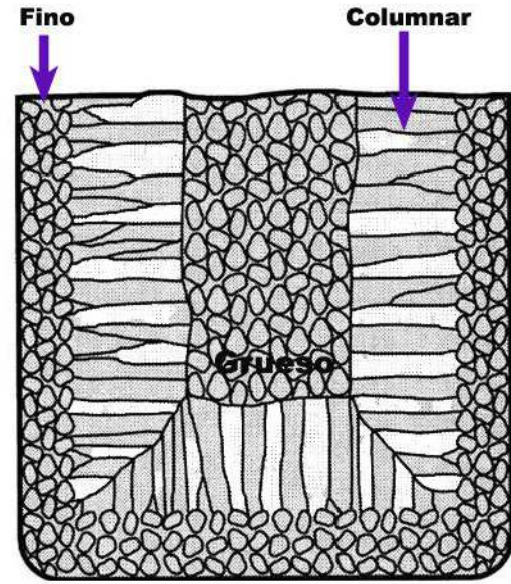

Enfriamiento lento

MACROESTRUCTURA DE UN LINGOTE DE ALUMINIO VACIADO EN MOLDE ABIERTO

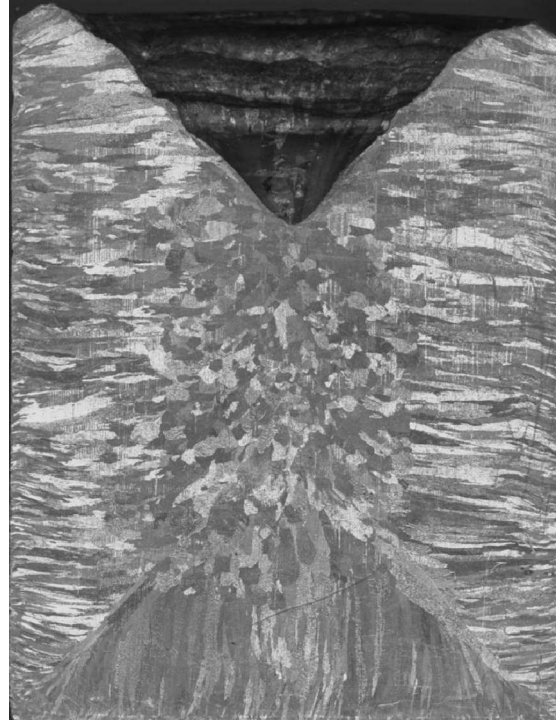

M.Met. Francisco A. Herrera C



CONTRACCIÓN Y FORMACIÓN DEL RECHUPE

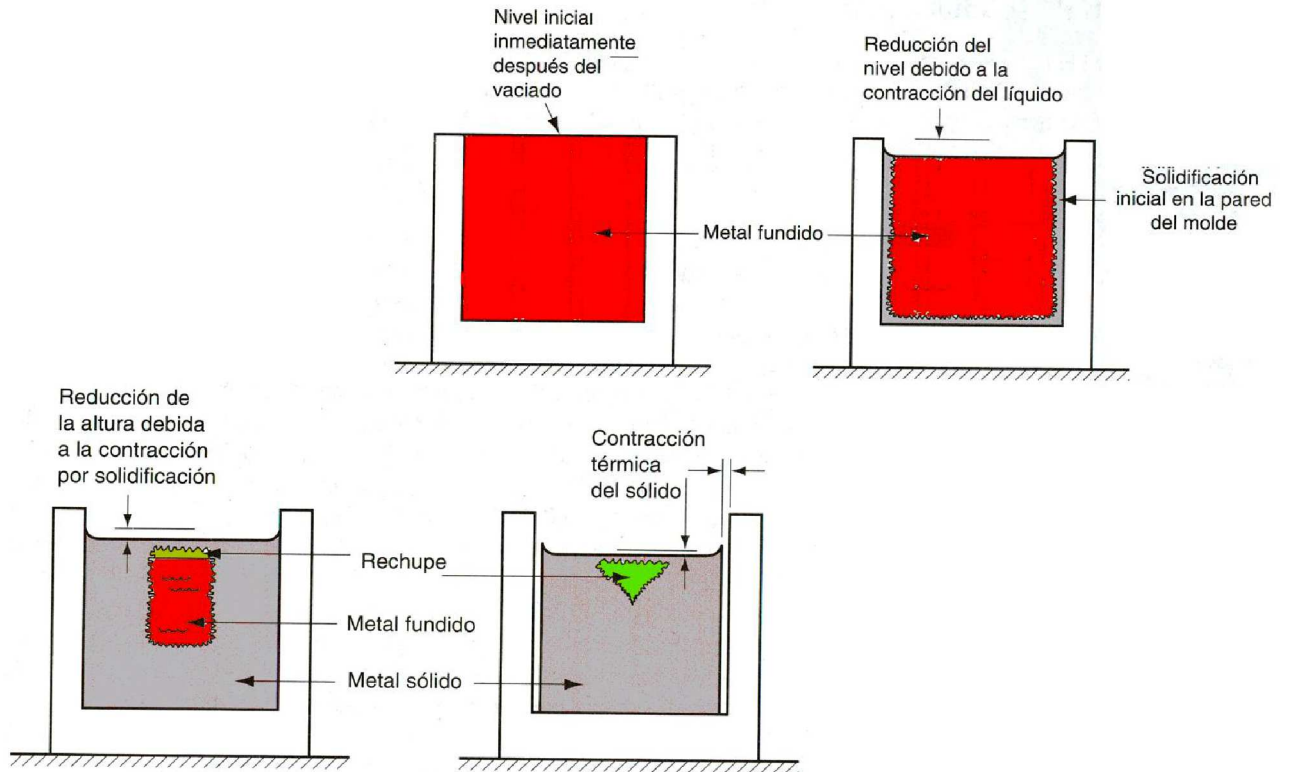



CONTRACCIÓN VOLUMÉTRICA

Metal	Contracción volumétrica debida a:	
	Contracción por solidificación %	Contracción térmica del sólido %
Aluminio	7.0	5.6
Aleación de Al	7.0	5.0
Hierro fundido gris	1.8	3.0
Acero bajo carbono	3.0	7.2
Cobre	4.5	7.5
Bronce (Cu-Sn)	5.5	6.0



TIEMPO DE SOLIDIFICACIÓN



El tiempo total de solidificación es el tiempo necesario para que la fundición solidifique después de que se ha llenado la cavidad. Este tiempo depende del tamaño y geometría de la cavidad. Esta relación se expresa mediante la "Regla de Chvorinov"



$$T_{\text{solid}} = C_m \left[\frac{V}{A} \right]^\eta$$



Donde:



T_{solid} = Tiempo de solidificación (min); V = volumen de la cavidad(cm^3); A = área superficial de la cavidad (cm^2); $\eta= 2$; C_m =const. del molde (min/cm^3)



La regla de Chvorinov indica que una fundición con una relación V/A se enfriará y solidificará más lentamente que otra con una relación más baja:

$$(V/A)_{\text{pieza 1}} > (V/A)_{\text{pieza 2}}$$



entonces la pieza 1 tardará más tiempo en solidificarse que la pieza 2

M.Met. Francisco A. Herrera C



DEFECTOS DE SOLIDIFICACIÓN PRODUCIDOS POR LA CONTRACCIÓN DEL METAL LÍQUIDO Y SÓLIDO

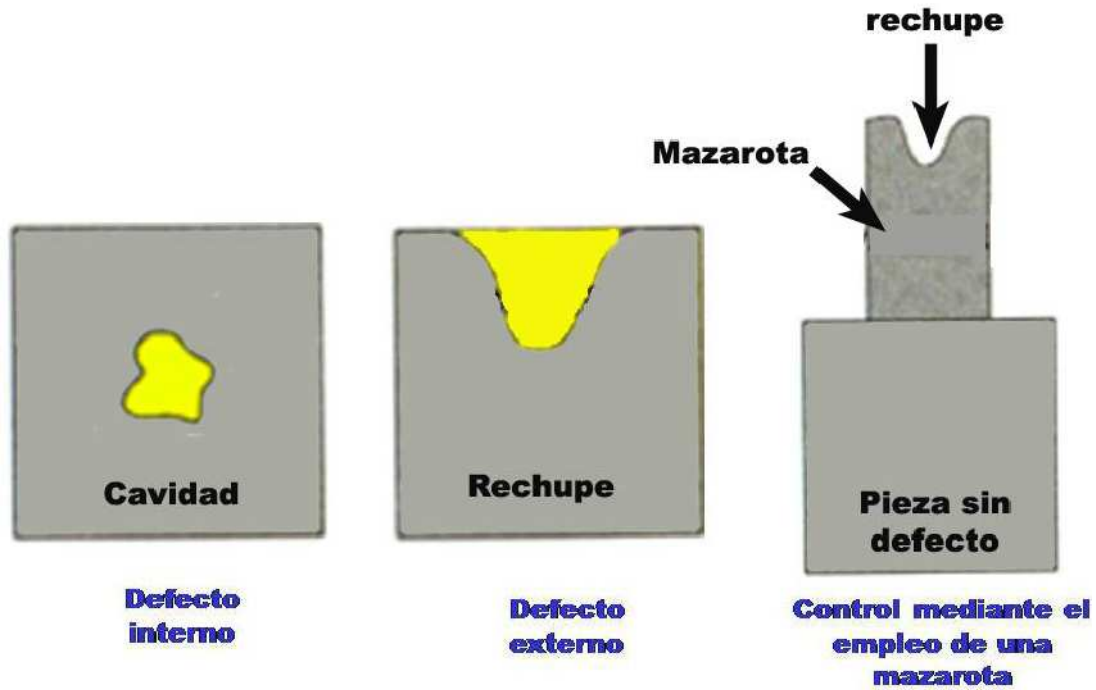

M.Met. Francisco A. Herrera C



DISEÑO DE MAZAROTAS

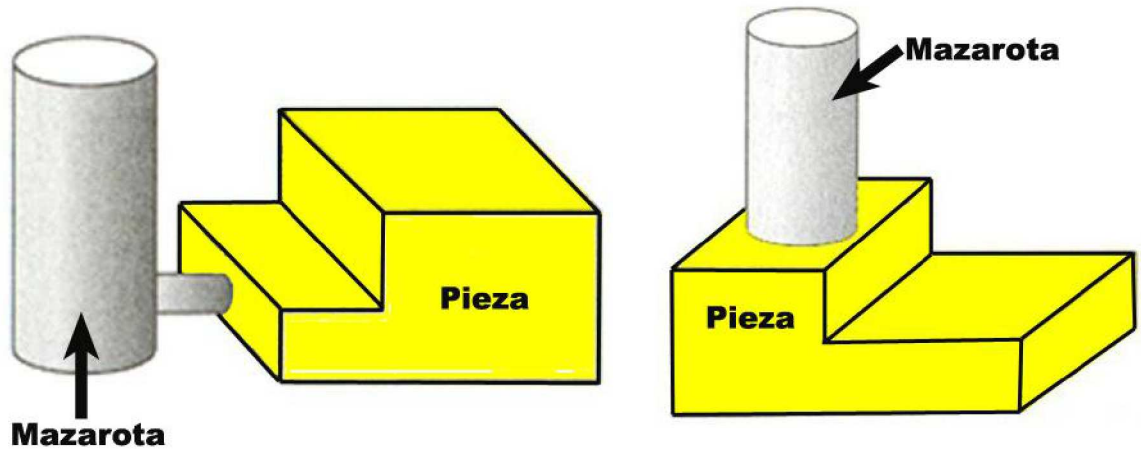

M.Met. Francisco A. Herrera C



CLASIFICACIÓN DE LOS PROCESOS DE FUNDICIÓN

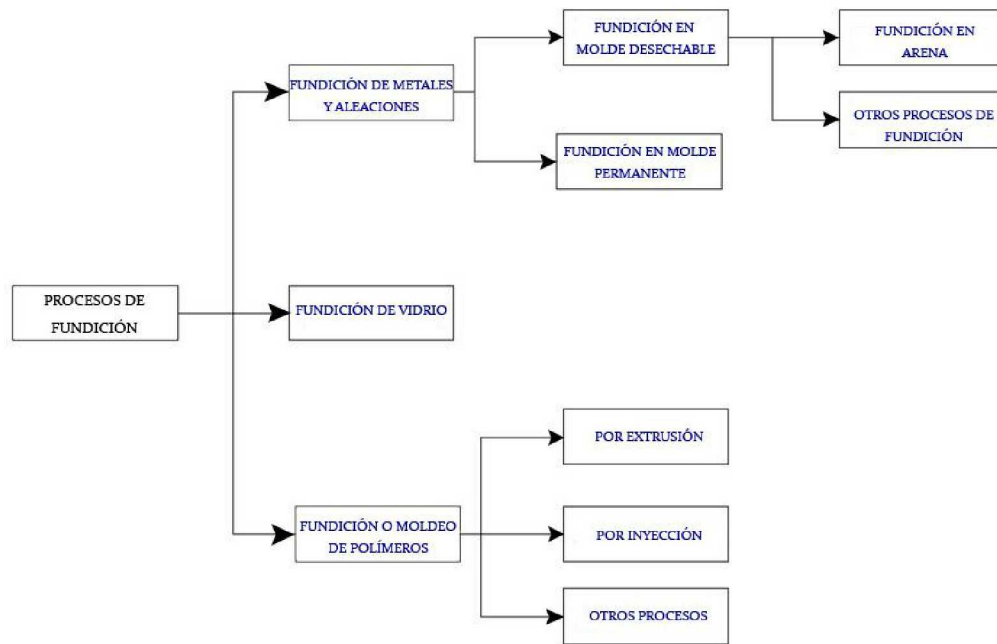

M.Met. Francisco A. Herrera C



PROCESO DE FUNDICIÓN EN ARENA

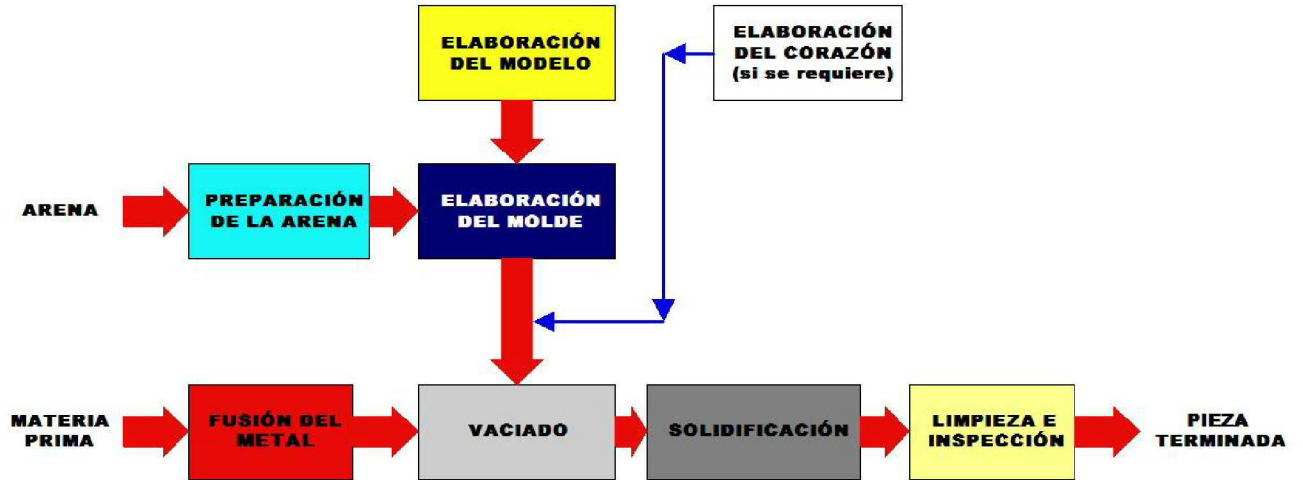



TIPOS DE MOLDE

MOLDE ABIERTO

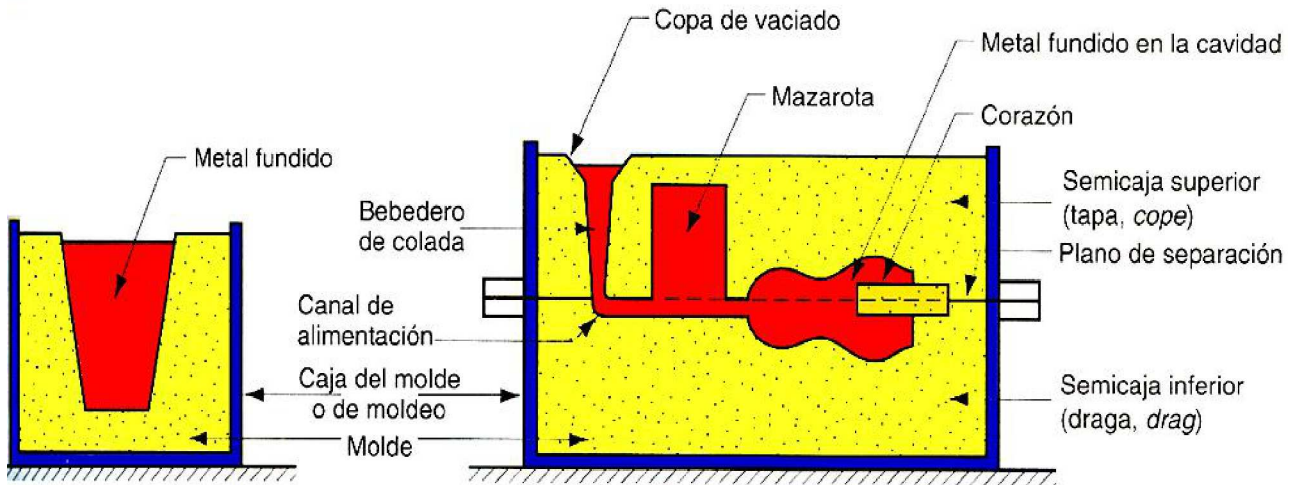

MOLDE CERRADO



VACIADO, SOLIDIFICACIÓN Y DESMOLDEO EN MOLDE DE ARENA

copa y bebedero de
vaciado

rebosadero

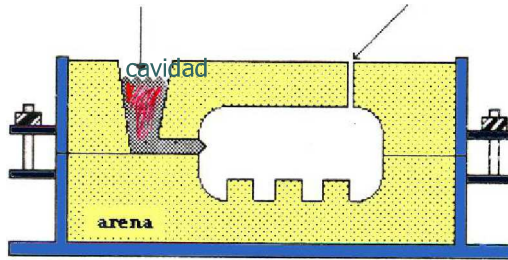

SOLIDIFICACIÓN

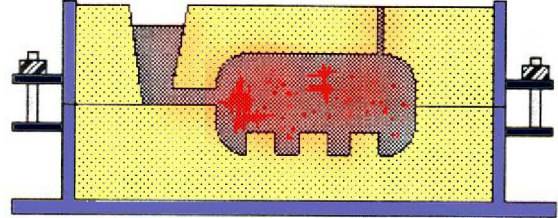

VACIADO

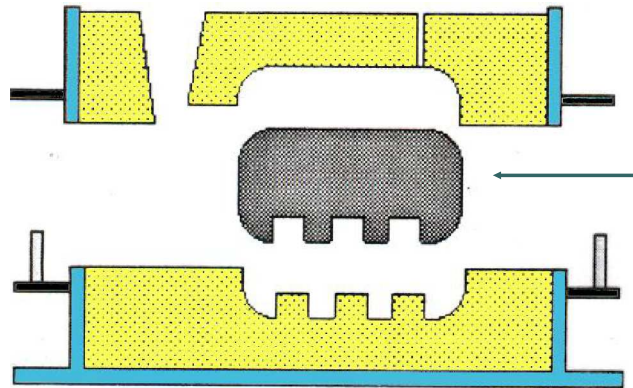

pieza
terminada

DESMOLDEO

M.Met. Francisco A. Herrera C





M.Met. Francisco A. Herrera C



M.Met. Francisco A. Herrera C

CABEZA DE PISTÓN (Aleación de Aluminio)

VACIADA EN ARENA

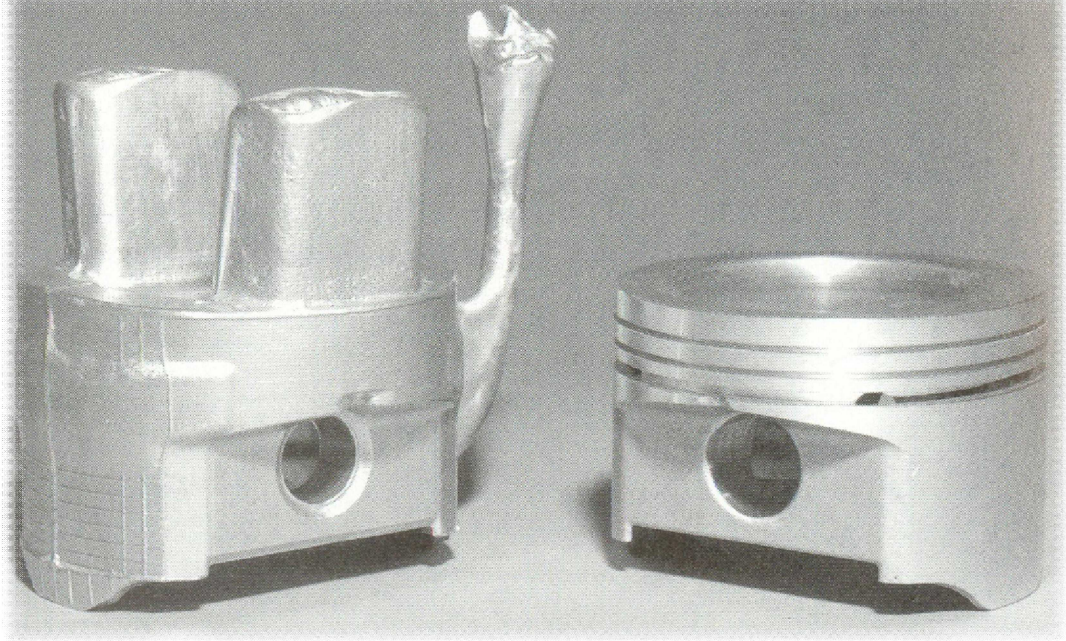

MAQUINADA

M.Met. Francisco A. Herrera C





TIPOS DE MODELOS

Modelo sólido

**Con placa
de acoplamiento**

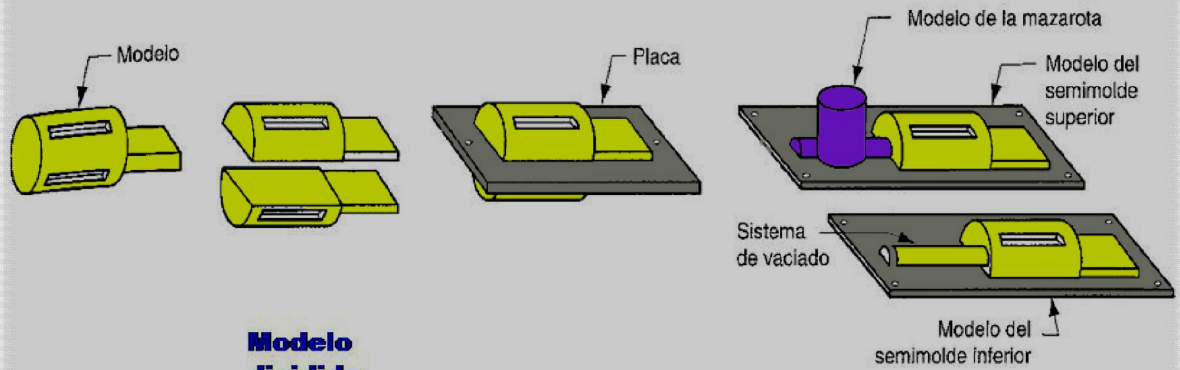

**Doble placa
Superior e inferior**

M.Met. Francisco A. Herrera C.

M.Met. Francisco A. Herrera C



MODELO DE DOBLE PLACA

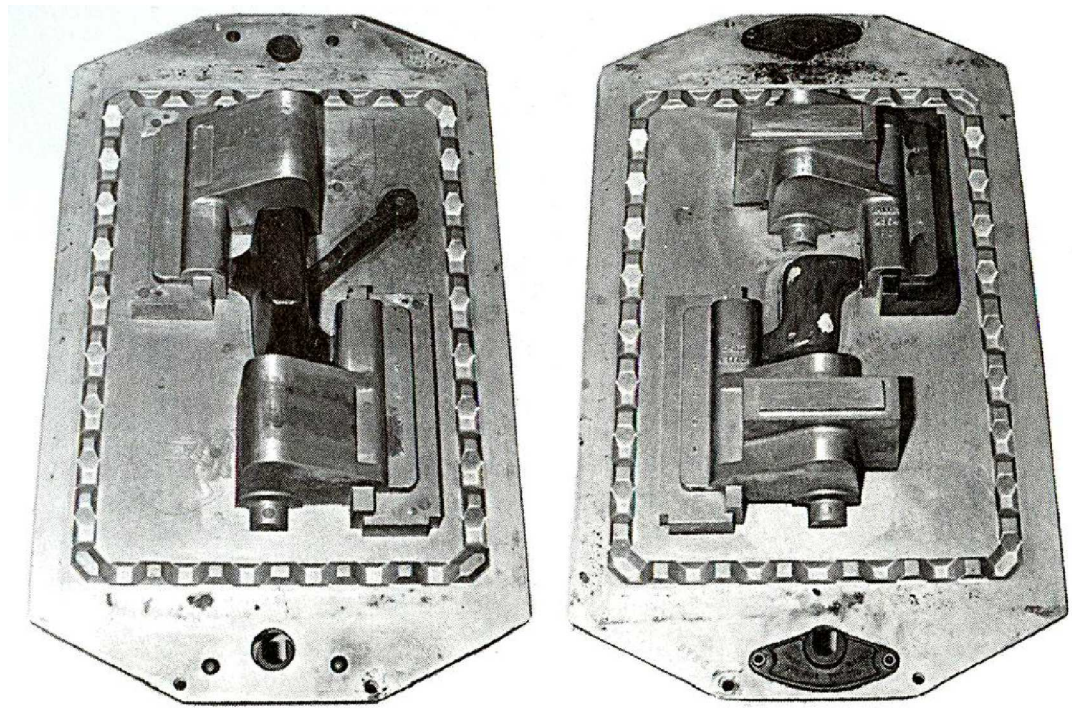

M.Met. Francisco A. Herrera C



PREPARACION DE UN MOLDE DE ARENA

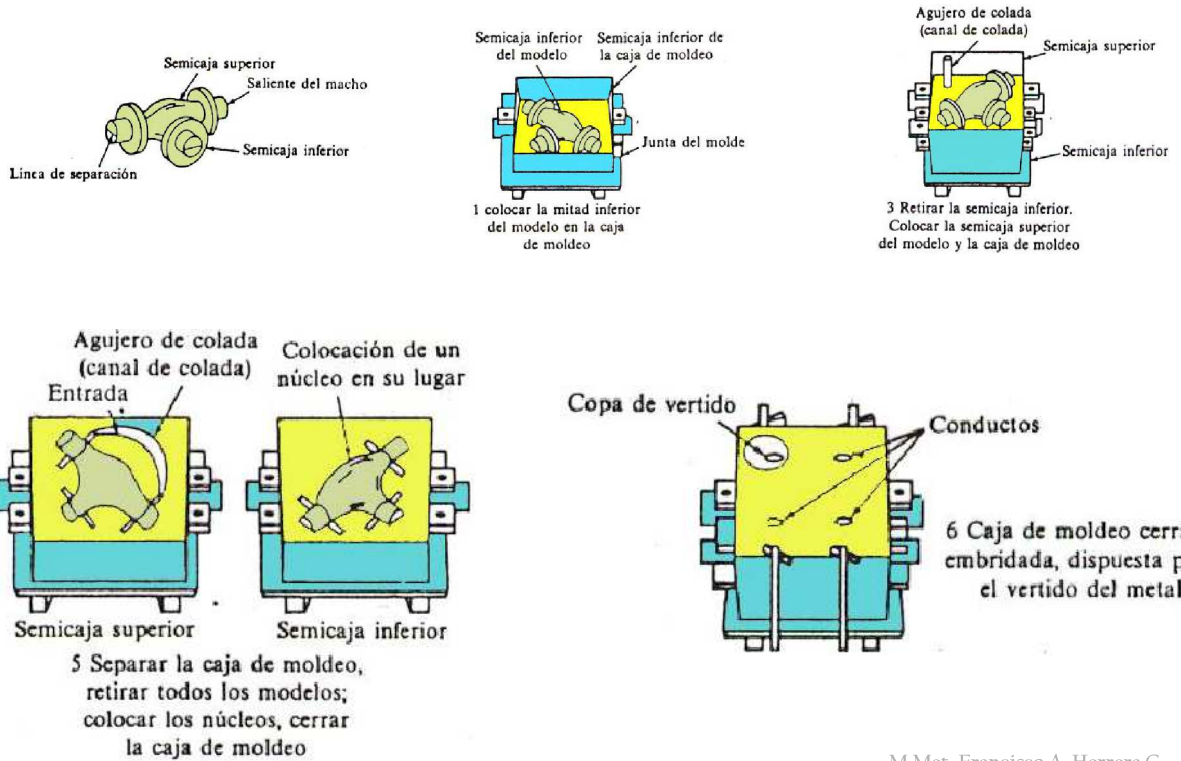



PREPARACION DE UN MOLDE DE ARENA



M.Met. Francisco A. Herrera C



M.Met. Francisco A. Herrera C



CORAZONES DE ARENA PARA UN MONOBLOCK

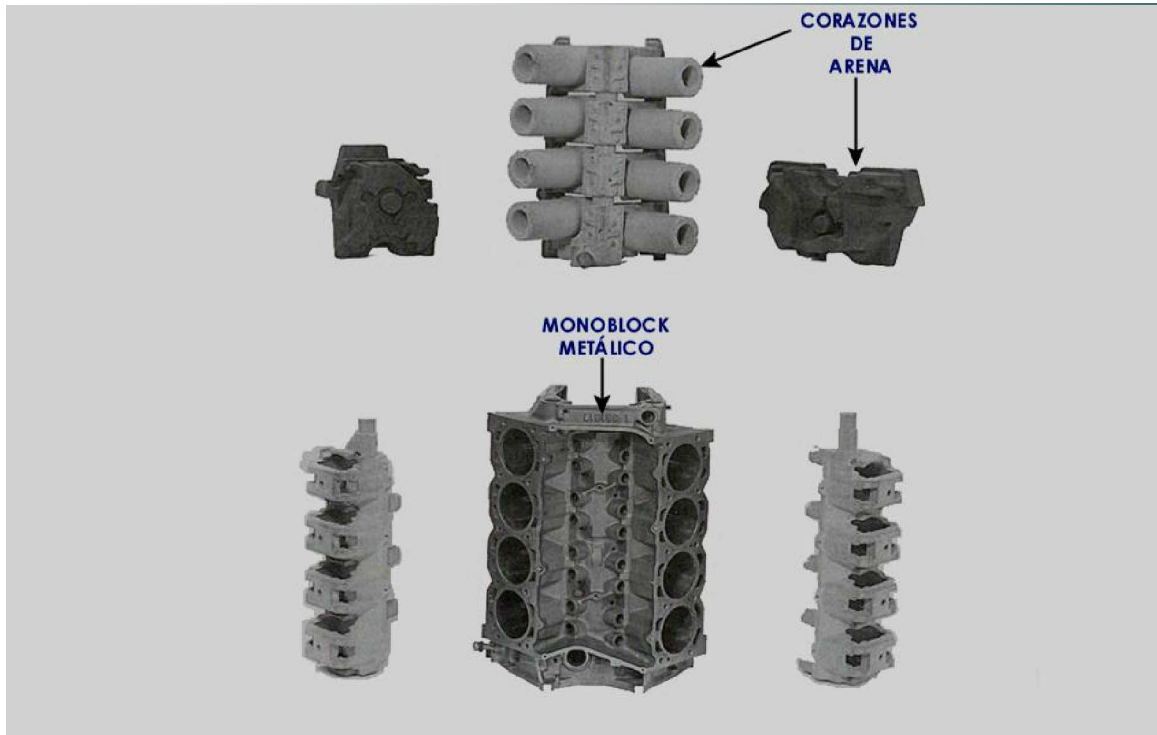

M.Met. Francisco A. Herrera C



COMPARATIVO MOLDE DE ARENA vs MOLDE PERMANENTE

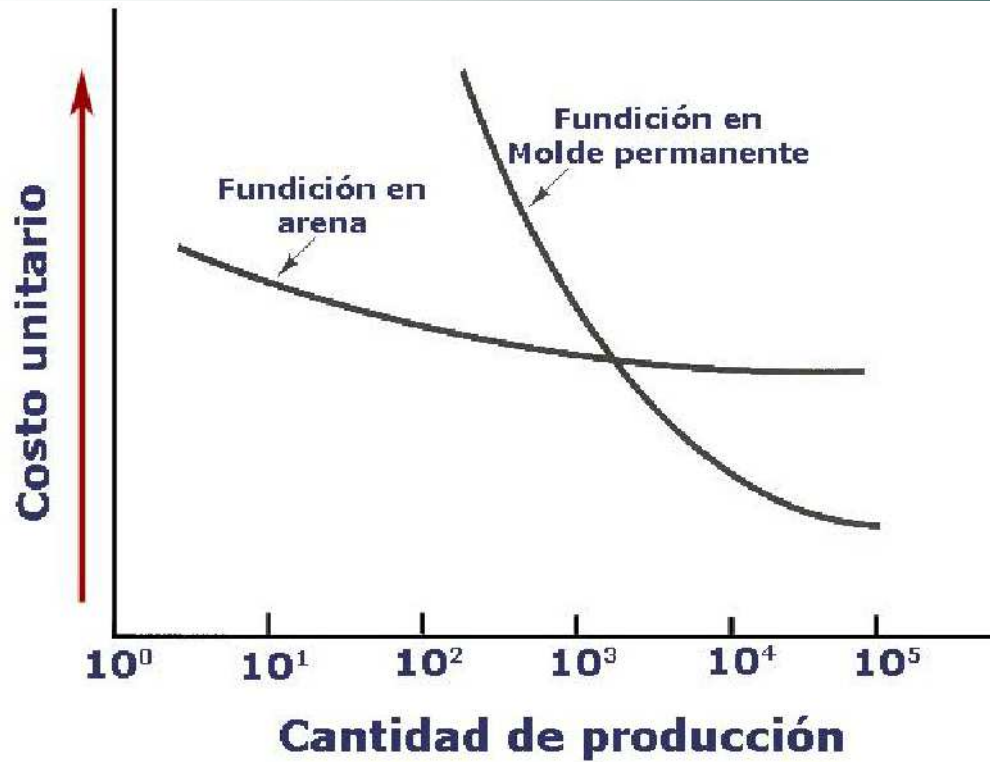

M.Met. Francisco A. Herrera C



PROCESO A LA CERA PERDIDA

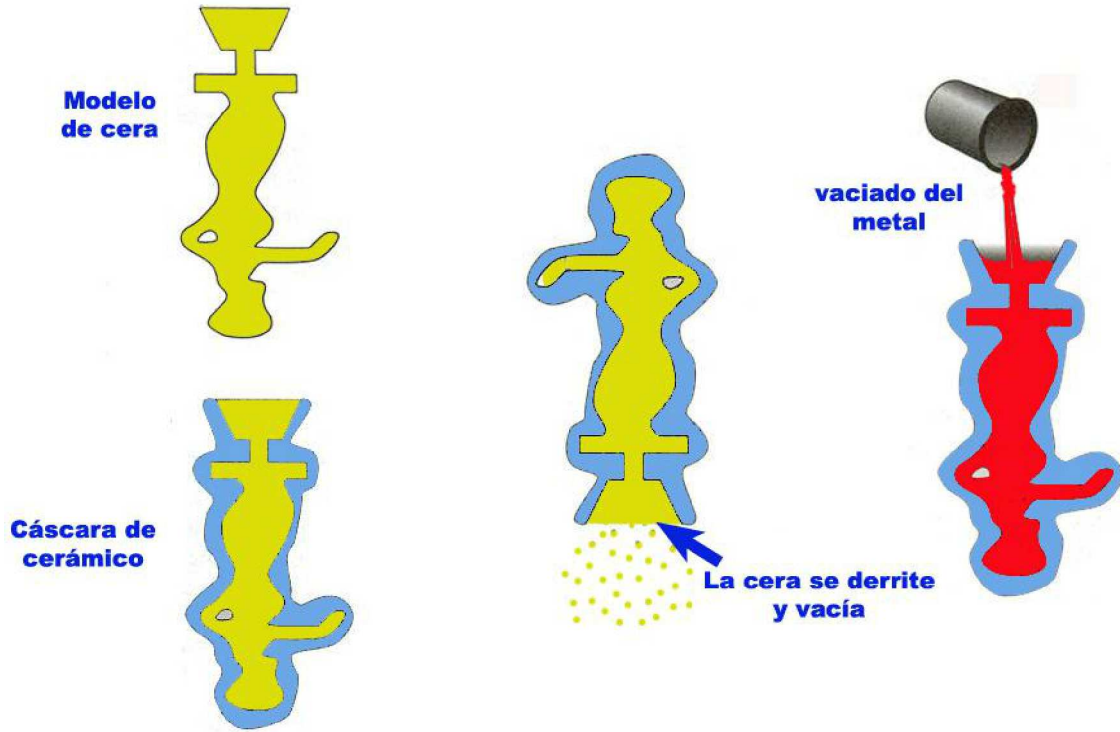

M.Met. Francisco A. Herrera C



FUNDICIÓN POR REVESTIMIENTO O A LA CERA PERDIDA

Modelo de cera

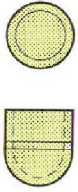

calentamiento

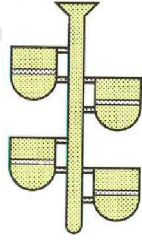

Elaboración del sistema de colada



Recubrimiento con material cerámico

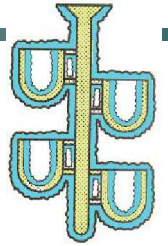

Endurecimiento del cerámico

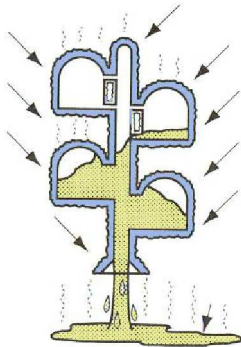

Escurrimiento de la cera

Vaciado del metal

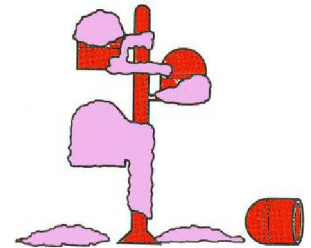
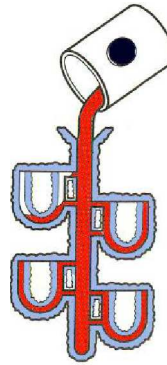

Rompimiento del cerámico

M.Met. Francisco A. Herrera C



M.Met. Francisco A. Herrera C

CICLO DE MOLDEO EMPLEANDO POLIESTIRENO



Modelo de poliestireno



Aspersión de compuesto cerámico

Arena compactada

caja

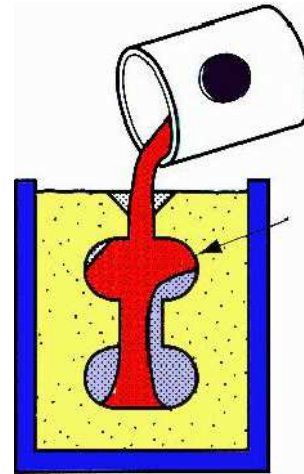
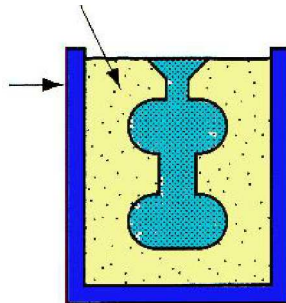

El metal vaporiza al poliestireno



MOLDE DE POLIESTIRENO PARA LA ELABORACIÓN DE UN MONOBLOCK

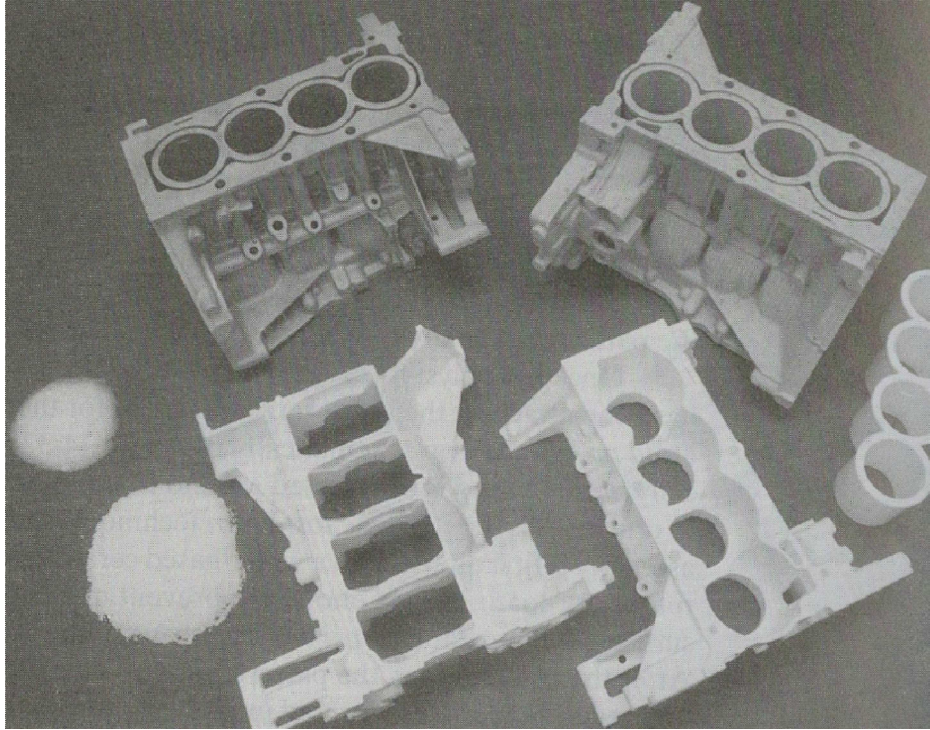

M.Met. Francisco A. Herrera C



FUNDICIÓN POR CONCHA O CASCARA

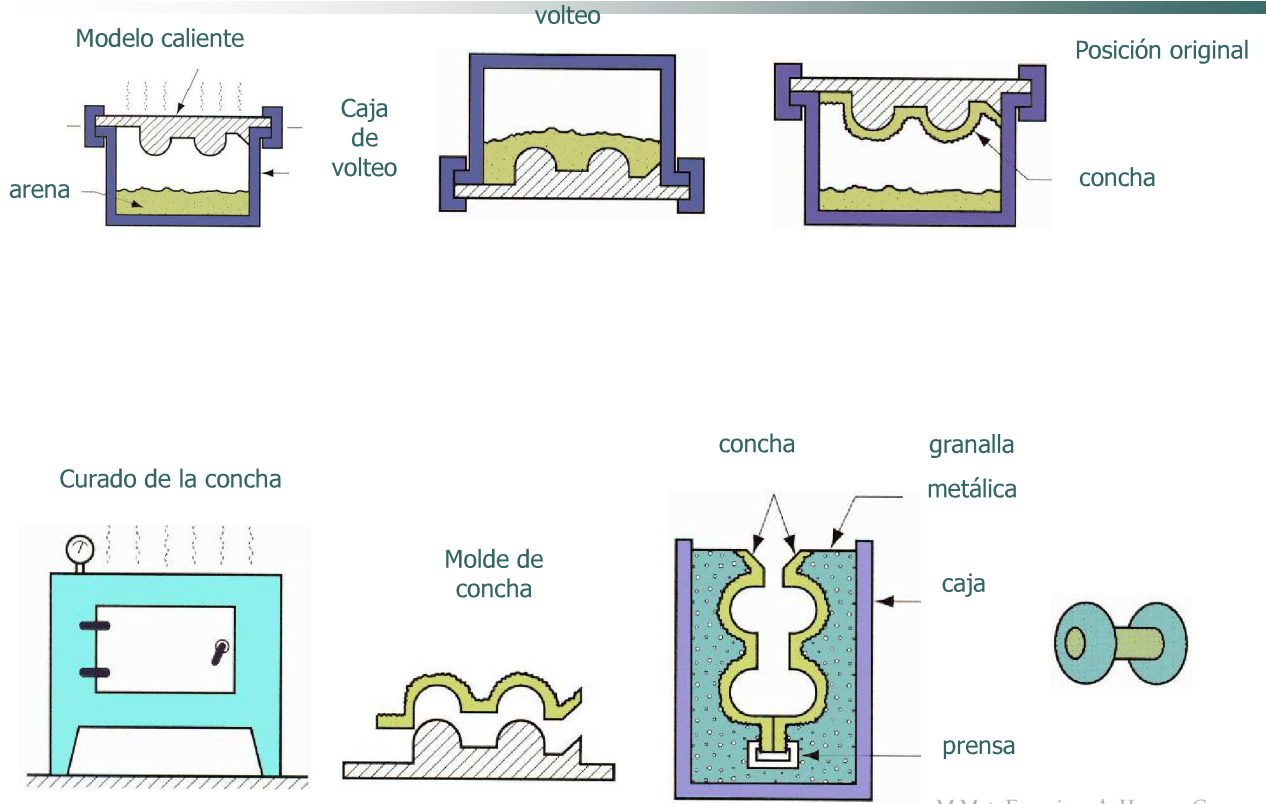

M.Met. Francisco A. Herrera C



FUNDICIÓN O MOLDEO AL VACÍO

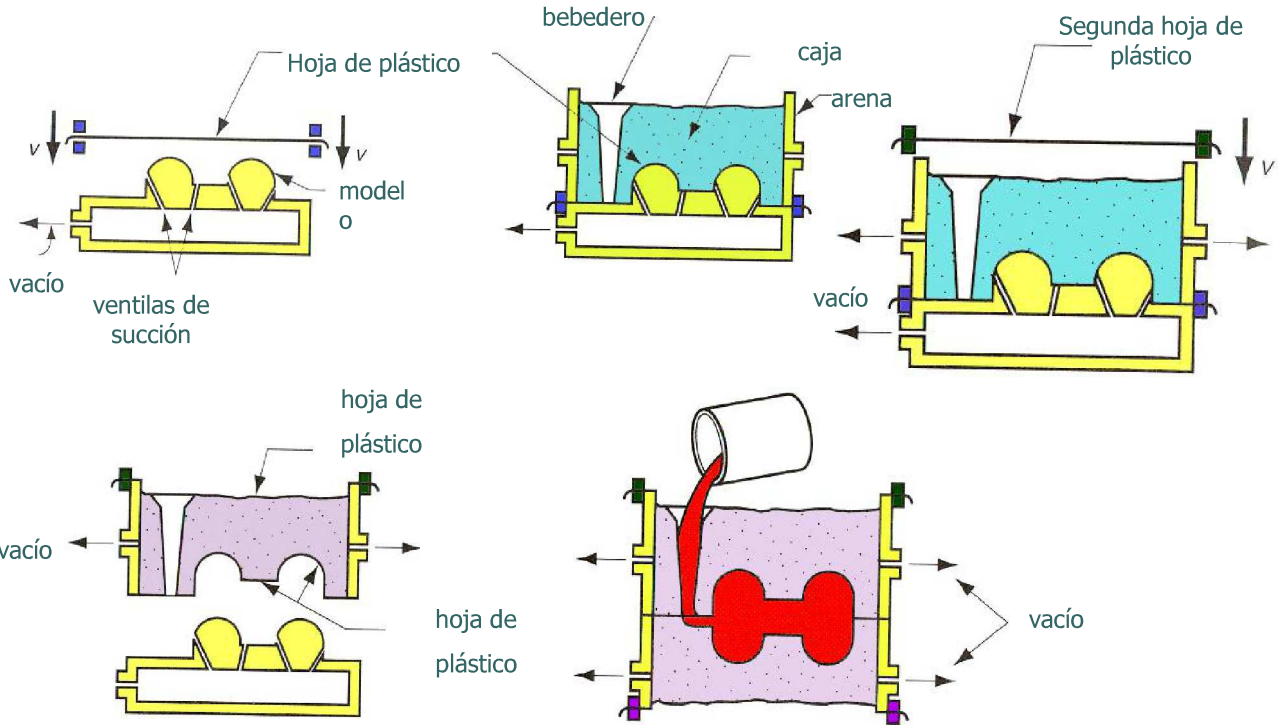

M.Met. Francisco A. Herrera C



FUNDICIÓN O MOLDEO EN MOLDE PERMANENTE

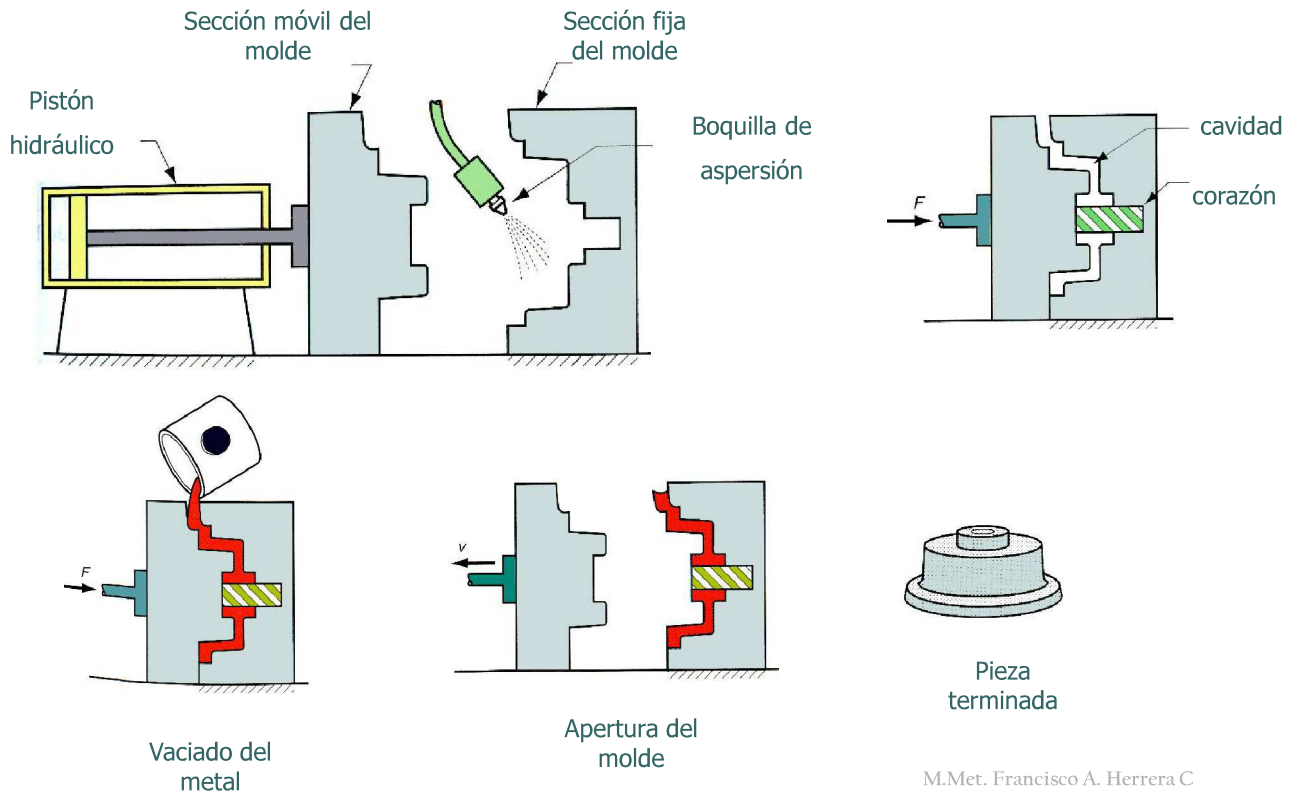

M.Met. Francisco A. Herrera C

FUNDICIÓN A BAJA PRESIÓN

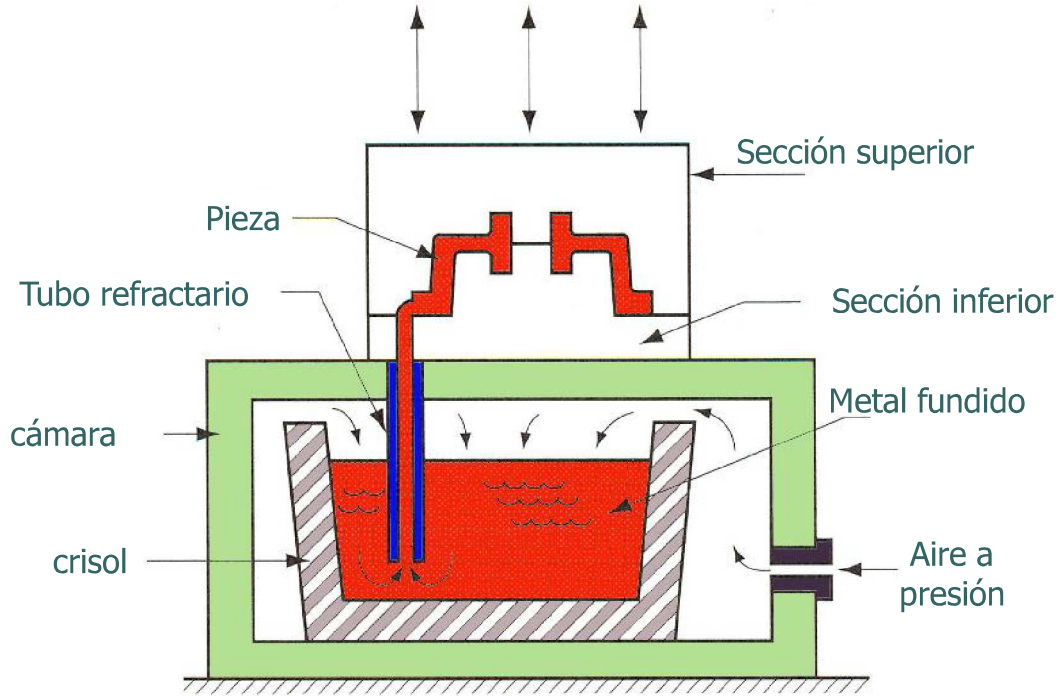

M.Met. Francisco A. Herrera C



FUNDICIÓN A PRESIÓN EN CÁMARA CALIENTE

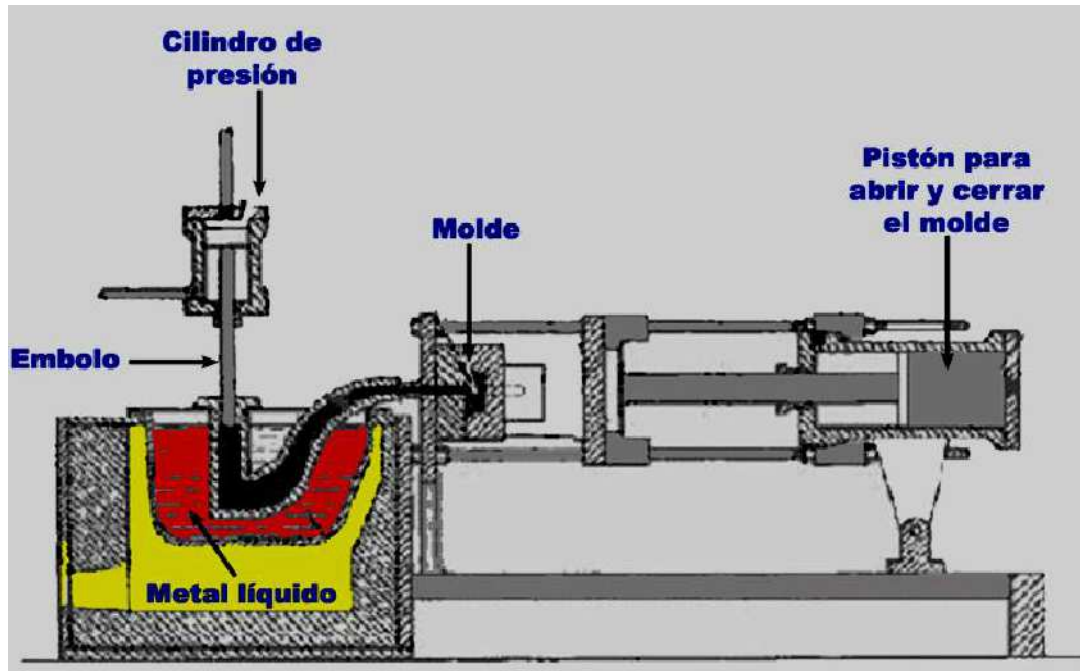

M.Met. Francisco A. Herrera C



FUNDICIÓN A PRESIÓN EN CÁMARA CALIENTE

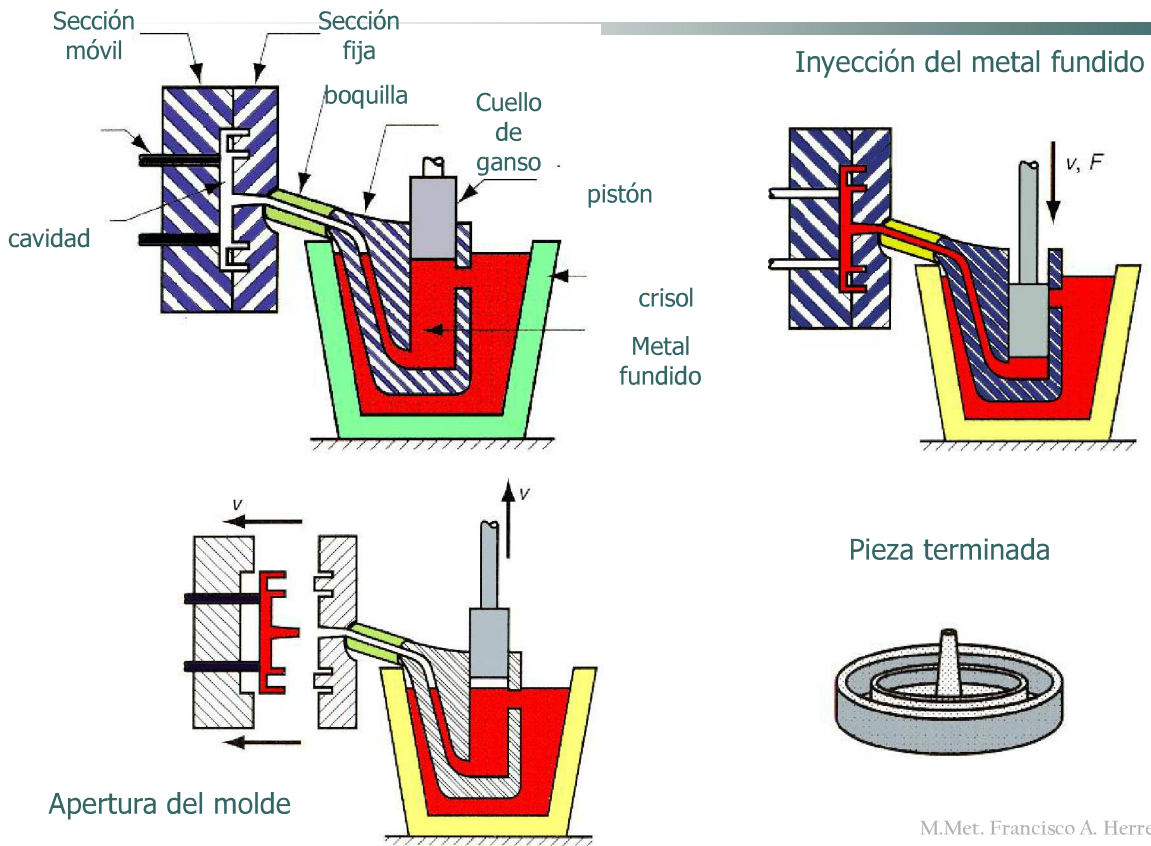

M.Met. Francisco A. Herrera C

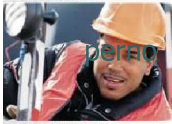

FUNDICIÓN A PRESIÓN EN CÁMARA FRÍA

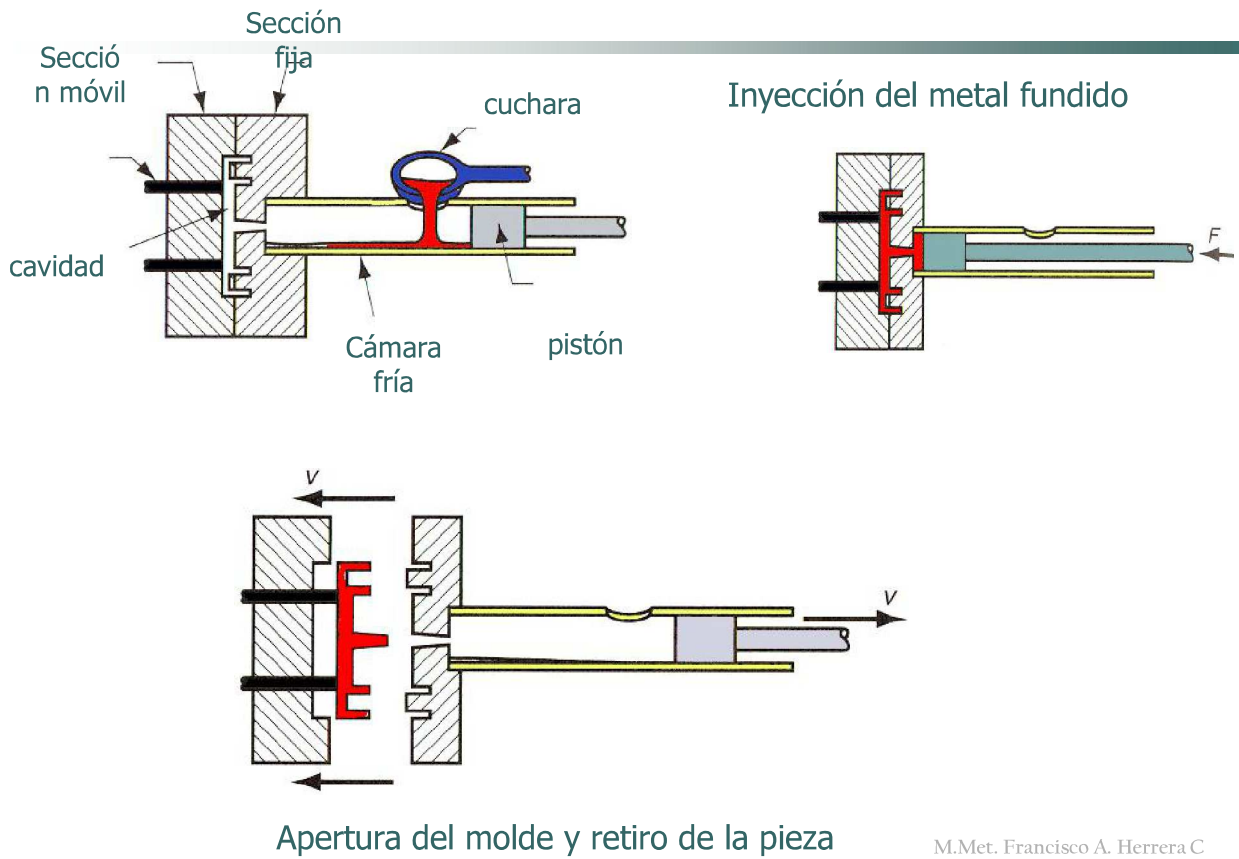

M.Met. Francisco A. Herrera C



PROCESO DE FUNDICIÓN CENTRIFUGADA

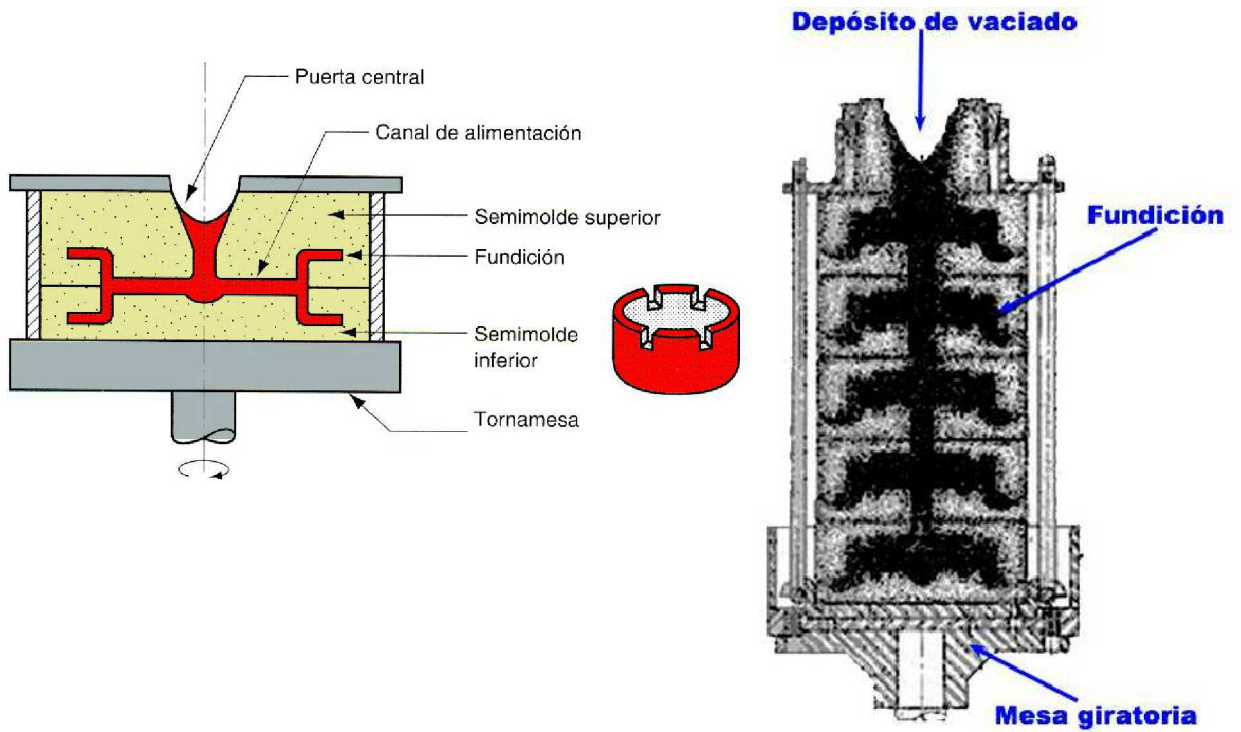

M.Met. Francisco A. Herrera C



Producción de tubos por centrifugado

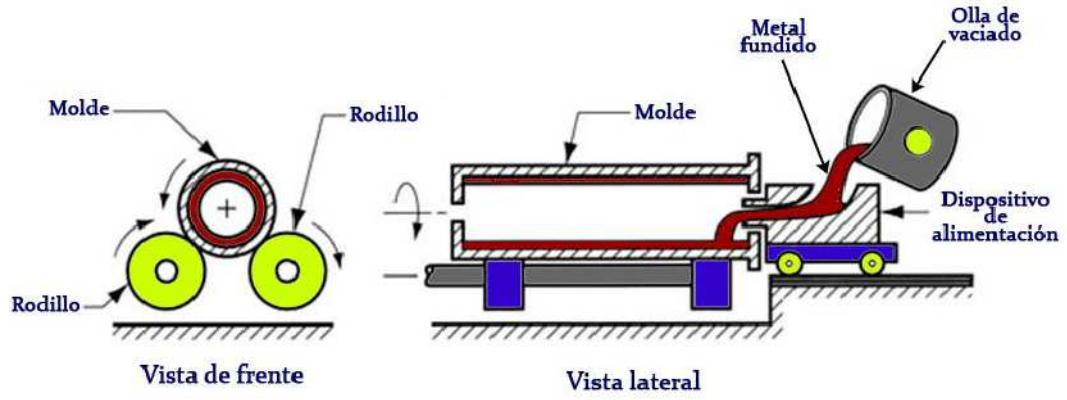



DEFECTOS O FALLAS COMUNES EN FUNDICIÓN

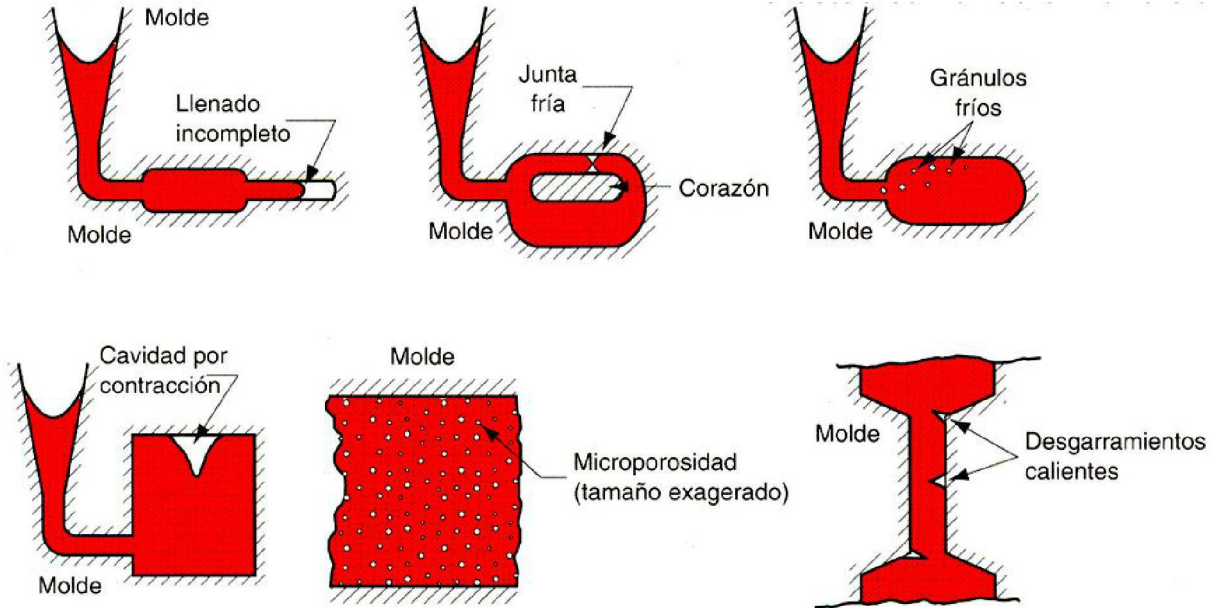

DEFECTOS COMUNES EN LA FUNDICIÓN CON MOLDE DE ARENA

