

getting to grips with
aircraft performance

Customer Services



AIRBUS

Flight Operations Support & Line Assistance

Customer Services

1, rond-point Maurice Bellonte, BP 33
31707 BLAGNAC Cedex FRANCE
Telephone (+33) 5 61 93 33 33
Telefax (+33) 5 61 93 29 68
Telex AIRBU 530526F
SITA TLSBI7X



getting to grips with
aircraft performance

January 2002



AIRBUS

1. INTRODUCTION	9
A. GENERAL	11
1. THE INTERNATIONAL STANDARD ATMOSPHERE (ISA)	11
1.1. STANDARD ATMOSPHERE MODELING	11
1.1.1. TEMPERATURE MODELING	11
1.1.2. PRESSURE MODELING	13
1.1.3. DENSITY MODELING	15
1.2. INTERNATIONAL STANDARD ATMOSPHERE (ISA) TABLE	15
2. ALTIMETRY PRINCIPLES	17
2.1. GENERAL	17
2.2. DEFINITIONS	18
2.3. EFFECTS OF ALTIMETER SETTING AND TEMPERATURE	20
2.3.1. ALTIMETER SETTING CORRECTION	20
2.3.2. TEMPERATURE CORRECTION	20
3. OPERATING SPEEDS	23
3.1. CALIBRATED AIR SPEED (CAS)	23
3.2. INDICATED AIR SPEED (IAS)	24
3.3. TRUE AIR SPEED (TAS)	24
3.4. GROUND SPEED (GS)	24
3.5. MACH NUMBER	25
3.6. TRUE AIR SPEED (TAS) VARIATIONS	26
4. FLIGHT MECHANICS	27
B. AIRCRAFT LIMITATIONS	29
1. FLIGHT LIMITATIONS	29
1.1. LIMIT LOAD FACTORS	29
1.2. MAXIMUM SPEEDS	30
1.3. MINIMUM SPEEDS	31
1.3.1. MINIMUM CONTROL SPEED ON THE GROUND: V_{MCG}	31
1.3.2. MINIMUM CONTROL SPEED IN THE AIR: V_{MCA}	32
1.3.3. MINIMUM CONTROL SPEED DURING APPROACH AND LANDING: V_{MCL}	33
1.3.4. MINIMUM UNSTICK SPEED: V_{MU}	34
1.3.5. STALL SPEED	35
2. MAXIMUM STRUCTURAL WEIGHTS	37
2.1. AIRCRAFT WEIGHT DEFINITIONS	37
2.2. MAXIMUM STRUCTURAL TAKEOFF WEIGHT (MTOW)	39
2.3. MAXIMUM STRUCTURAL LANDING WEIGHT (MLW)	39
2.4. MAXIMUM STRUCTURAL ZERO FUEL WEIGHT (MZFW)	39
2.5. MAXIMUM STRUCTURAL TAXI WEIGHT (MTW)	40
3. MINIMUM STRUCTURAL WEIGHT	40
4. ENVIRONMENTAL ENVELOPE	40

5. ENGINE LIMITATIONS	41
5.1. THRUST SETTING AND EGT LIMITATIONS	41
5.2. TAKEOFF THRUST LIMITATIONS	42
C. TAKEOFF	43
1. INTRODUCTION	43
2. TAKEOFF SPEEDS	44
2.1. OPERATIONAL TAKEOFF SPEEDS	44
2.1.1. ENGINE FAILURE SPEED: V_{EF}	44
2.1.2. DECISION SPEED: V_1	44
2.1.3. ROTATION SPEED: V_R	46
2.1.4. LIFT-OFF SPEED: V_{LOF}	46
2.1.5. TAKEOFF CLIMB SPEED: V_2	47
2.2. TAKEOFF SPEED LIMITS	48
2.2.1. MAXIMUM BRAKE ENERGY SPEED: V_{MBE}	48
2.2.2. MAXIMUM TIRE SPEED: V_{TIRE}	48
2.3. SPEED SUMMARY	48
3. RUNWAY LIMITATIONS	49
3.1. TAKEOFF DISTANCES	49
3.1.1. REGULATORY BACKGROUND	49
3.1.2. TAKEOFF DISTANCE (TOD)	50
3.1.3. TAKEOFF RUN (TOR)	52
3.1.4. ACCELERATE-STOP DISTANCE (ASD)	53
3.1.5. INFLUENCE OF V_1 ON ACCELERATE-GO/STOP DISTANCES	55
3.2. AVAILABLE TAKEOFF LENGTHS	56
3.2.1. TAKEOFF RUN AVAILABLE (TORA)	56
3.2.2. TAKEOFF DISTANCE AVAILABLE (TODA)	56
3.2.3. ACCELERATE-STOP DISTANCE AVAILABLE (ASDA)	57
3.2.4. LOSS OF RUNWAY LENGTH DUE TO ALIGNMENT	58
3.2.5. INFLUENCE OF V_1 ON THE RUNWAY-LIMITED TAKEOFF WEIGHT	61
4. CLIMB AND OBSTACLE LIMITATIONS	62
4.1. TAKEOFF FLIGHT PATH	62
4.1.1. DEFINITIONS	62
4.1.2. TAKEOFF SEGMENTS AND CLIMB REQUIREMENTS	62
4.1.3. MINIMUM AND MAXIMUM ACCELERATION HEIGHTS	64
4.1.4. TAKEOFF TURN PROCEDURE	65
4.2. OBSTACLE CLEARANCE	67
4.2.1. GROSS AND NET TAKEOFF FLIGHT PATHS	67
4.2.2. OBSTACLE CLEARANCE DURING A STRAIGHT TAKEOFF	68
4.2.3. OBSTACLE CLEARANCE DURING A TURN	68
4.2.4. LOSS OF GRADIENT DURING A TURN	69
4.2.5. TAKEOFF FLIGHT PATH WITH OBSTACLES	70
4.2.6. TAKEOFF FUNNEL	71
5. OUTSIDE ELEMENTS	74
5.1. WIND	74
5.2. PRESSURE ALTITUDE	75
5.2.1. EFFECT ON AERODYNAMICS	75
5.2.2. EFFECT ON ENGINES	76
5.2.3. SUMMARY	76

5.3. TEMPERATURE	76
5.3.1. EFFECT ON AERODYNAMICS	76
5.3.2. EFFECT ON ENGINES	76
5.3.3. SUMMARY	77
5.4. RUNWAY SLOPE	77
5.5. RUNWAY CONDITIONS (DRY, DAMP, WET, CONTAMINATED)	77
5.5.1. DEFINITIONS	78
5.5.2. EFFECT ON PERFORMANCE	79
5.5.3. AIRCRAFT MANUFACTURER DATA	82
5.5.4. TAKEOFF PERFORMANCE ON WET AND CONTAMINATED RUNWAYS	83
6. MAXIMUM TAKEOFF WEIGHT DETERMINATION	84
6.1. SPEED OPTIMIZATION PROCESS	84
6.2. REGULATORY TAKEOFF WEIGHT CHART (RTOW CHART)	85
7. FLEXIBLE AND DERATED TAKEOFF	87
7.1. FLEXIBLE TAKEOFF	87
7.1.1. DEFINITION	87
7.1.2. FLEXIBLE TAKEOFF AND RUNWAY STATE	88
7.1.3. FLEXIBLE TEMPERATURE DETERMINATION	89
7.1.4. FLEXIBLE TAKEOFF PROCEDURE	89
7.2. DERATED TAKEOFF	90
7.2.1. DEFINITION	90
7.2.2. MINIMUM CONTROL SPEEDS WITH DERATED THRUST	90
7.2.3. DERATED TAKEOFF AND RUNWAY STATE	91
7.2.4. DERATED TAKEOFF PROCEDURE	92
D. EN ROUTE LIMITATIONS	93
1. EN ROUTE FAILURE CASES	93
2. ENGINE FAILURE(S)	93
2.1. GENERAL DEFINITIONS	93
2.1.1. DRIFT DOWN PROCEDURE	93
2.1.2. GROSS AND NET DRIFT DOWN FLIGHT PATHS	94
2.1.3. TAKEOFF ALTERNATE AIRPORT	95
2.2. EN ROUTE OBSTACLE CLEARANCE – ONE ENGINE INOPERATIVE	96
2.2.1. LATERAL CLEARANCE	96
2.2.2. VERTICAL CLEARANCE	97
2.2.3. DIVERSION AIRFIELD	101
2.3. TWIN ENGINE AIRCRAFT	102
2.3.1. 60 MINUTE RULE	102
2.4. FOUR ENGINE AIRCRAFT	102
2.4.1. 90 MINUTE RULE	102
2.4.2. OBSTACLE CLEARANCE – TWO ENGINES INOPERATIVE	103
2.4.3. DIVERSION AIRFIELD – TWO ENGINES INOPERATIVE	104
3. IN-FLIGHT CABIN PRESSURIZATION FAILURE	105
3.1.1. OXYGEN SYSTEMS	105
3.1.2. PASSENGER OXYGEN REQUIREMENT	106
3.1.3. FLIGHT PROFILE	107
3.1.4. MINIMUM FLIGHT ALTITUDES	108
3.1.5. OBSTACLE CLEARANCE – CABIN PRESSURIZATION FAILURE	109
4. ROUTE STUDY	110

E. LANDING	111
1. INTRODUCTION	111
2. LANDING DISTANCE AVAILABLE (LDA)	111
2.1. WITH NO OBSTACLE UNDER LANDING PATH	111
2.2. WITH OBSTACLES UNDER LANDING PATH	111
3. LANDING PERFORMANCE	112
3.1. OPERATING LANDING SPEEDS	112
3.1.1. LOWEST SELECTABLE SPEED: V_{LS}	113
3.1.2. FINAL APPROACH SPEED: V_{APP}	113
3.1.3. REFERENCE SPEED: V_{REF}	114
3.2. ACTUAL LANDING DISTANCE (ALD)	114
3.2.1. MANUAL LANDING	114
3.2.2. AUTOMATIC LANDING	116
3.3. GO-AROUND PERFORMANCE REQUIREMENTS	117
3.3.1. APPROACH CLIMB	117
3.3.2. LANDING CLIMB	118
3.4. EXTERNAL PARAMETERS INFLUENCE	119
3.4.1. PRESSURE ALTITUDE	119
3.4.2. TEMPERATURE	119
3.4.3. RUNWAY SLOPE	119
3.4.4. RUNWAY CONDITIONS	120
3.4.5. AIRCRAFT CONFIGURATION	120
4. DISPATCH REQUIREMENTS	121
4.1. REQUIRED LANDING DISTANCE (RLD)	121
4.1.1. RLD DRY RUNWAYS	121
4.1.2. RLD WET RUNWAYS	121
4.1.3. RLD CONTAMINATED RUNWAYS	122
4.1.4. RLD WITH AUTOMATIC LANDING (DRY)	122
4.2. GO-AROUND REQUIREMENTS	123
4.2.1. NORMAL APPROACH	123
4.2.2. CAT II OR CAT III APPROACH	123
4.3. CONCLUSION	123
5. IN-FLIGHT REQUIREMENTS	124
5.1. IN-FLIGHT FAILURE	124
5.2. OVERWEIGHT LANDING REQUIREMENTS	124
5.3. FUEL JETTISONING CONDITIONS	125
F. CRUISE	127
1. GENERAL	127
1.1. INTRODUCTION	127
1.2. SPECIFIC RANGE	127
2. SPEED OPTIMIZATION	128
2.1. ALL ENGINE OPERATING CRUISE SPEEDS	128
2.1.1. MAXIMUM RANGE MACH NUMBER (M_{MR})	128
2.1.2. LONG-RANGE CRUISE MACH NUMBER (M_{LRC})	130
2.1.3. ECONOMIC MACH NUMBER (M_{ECON})	131
2.1.4. CONSTANT MACH NUMBER	133

3. ALTITUDE OPTIMIZATION	133
3.1. OPTIMUM CRUISE ALTITUDE	133
3.1.1. AT A CONSTANT MACH NUMBER	133
3.1.2. WIND INFLUENCE	135
3.2. MAXIMUM CRUISE ALTITUDE	138
3.2.1. LIMIT MACH NUMBER AT CONSTANT ALTITUDE	138
3.2.2. MAXIMUM CRUISE ALTITUDE	138
3.3. EN ROUTE MANEUVER LIMITS	141
3.3.1. LIFT RANGE	141
3.3.2. OPERATING MANEUVER LIMITATIONS	142
3.4. CRUISE OPTIMIZATION: STEP CLIMB	147
4. FCOM CRUISE TABLE	147
G. CLIMB	149
1. FLIGHT MECHANICS	149
1.1. DEFINITIONS	149
1.2. CLIMB EQUATIONS	149
1.2.1. CLIMB GRADIENT (γ)	150
1.2.2. RATE OF CLIMB (RC)	151
1.2.3. SPEED POLAR	151
1.3. INFLUENCING PARAMETERS	152
1.3.1. ALTITUDE EFFECT	152
1.3.2. TEMPERATURE EFFECT	153
1.3.3. WEIGHT EFFECT	153
1.3.4. WIND EFFECT	153
2. CLIMB IN OPERATION	154
2.1. CLIMB MANAGEMENT	154
2.1.1. THRUST SETTING	154
2.1.2. ENERGY SHARING	154
2.1.3. CLIMB CEILING	155
2.2. CLIMB SPEEDS	155
2.2.1. CLIMB AT GIVEN IAS/MACH LAW	155
2.2.2. CLIMB AT MAXIMUM GRADIENT	156
2.2.3. CLIMB AT MAXIMUM RATE	156
2.2.4. CLIMB AT MINIMUM COST	156
2.3. FCOM CLIMB TABLE	157
2.4. CABIN CLIMB	158
H. DESCENT / HOLDING	159
1. FLIGHT MECHANICS	159
1.1. DEFINITIONS	159
1.2. DESCENT EQUATIONS	159
1.2.1. DESCENT GRADIENT (γ)	159
1.2.2. RATE OF DESCENT (RD)	160
1.2.3. SPEED POLAR	161
1.3. INFLUENCING PARAMETERS	161
1.3.1. ALTITUDE EFFECT	161
1.3.2. TEMPERATURE EFFECT	162
1.3.3. WEIGHT EFFECT	162
1.3.4. WIND EFFECT	163

2. DESCENT IN OPERATION	164
2.1. THRUST SETTING	164
2.2. DESCENT SPEEDS	164
2.2.1. DESCENT AT GIVEN MACH/IAS LAW	164
2.2.2. DESCENT AT MINIMUM GRADIENT (DRIFT DOWN)	165
2.2.3. DESCENT AT MINIMUM RATE	165
2.2.4. DESCENT AT MINIMUM COST	165
2.2.5. EMERGENCY DESCENT	166
2.3. FCOM DESCENT TABLE	166
2.4. CABIN DESCENT	167
3. HOLDING	168
3.1. HOLDING SPEED	168
3.2. HOLDING IN OPERATION	169
I. FUEL PLANNING AND MANAGEMENT	171
1. JAR - FUEL PLANNING AND MANAGEMENT	171
1.1. FUEL POLICY	171
1.1.1. STANDARD FLIGHT PLANNING	171
1.1.2. ISOLATED AIRPORT PROCEDURE	175
1.1.3. UNREQUIRED DESTINATION ALTERNATE AIRPORT	175
1.1.4. DECISION POINT PROCEDURE	175
1.1.5. PRE-DETERMINED POINT PROCEDURE	177
1.1.6. ETOPS PROCEDURE	177
1.2. FUEL MANAGEMENT	179
1.2.1. MINIMUM FUEL AT LANDING AIRPORT	179
1.2.2. MINIMUM FUEL AT DESTINATION AIRPORT	179
2. FAR - FUEL PLANNING AND MANAGEMENT	181
2.1. DIFFERENT TYPES OF OPERATIONS	181
2.2. FUEL POLICY	182
2.2.1. DOMESTIC OPERATIONS	182
2.2.2. FLAG AND SUPPLEMENTAL OPERATIONS	184
2.2.3. ISOLATED AIRPORT PROCEDURE	186
2.2.4. UNREQUIRED DESTINATION ALTERNATE AIRPORT	186
2.2.5. REDISPATCH PROCEDURE	187
2.2.6. ETOPS PROCEDURE	188
2.2. FUEL MANAGEMENT	188
2.2.1. MINIMUM FUEL AT LANDING AIRPORT	188
J. APPENDIX	189
1. APPENDIX 1 : ALTIMETRY - TEMPERATURE EFFECT	189
2. APPENDIX 2 : TAKEOFF OPTIMIZATION PRINCIPLE	192
2.1. TAKEOFF CONFIGURATION	192
2.2. AIR CONDITIONING	193
2.3. TAKEOFF SPEED OPTIMIZATION	193
2.3.1. SPEED RATIOS: V_1/V_R AND V_2/V_S	193
2.3.2. V_1/V_R RATIO INFLUENCE	194
2.3.3. V_2/V_S RATIO INFLUENCE	197
2.4. RESULT OF THE OPTIMIZATION PROCESS	199
2.4.1. MAXIMUM TAKEOFF WEIGHT	199

2.4.2. TAKEOFF SPEEDS	200
2.4.3. LIMITATION CODES	200
2.4.4. RTOW CHART INFORMATION	202
3. APPENDIX 3 : TAKEOFF PERFORMANCE SOFTWARE	203
3.1. P.E.P FOR WINDOWS	203
3.1.1. WHAT IS P.E.P. ?	203
3.1.2. TLO MODULE	204
3.2. LESS PAPER COCKPIT (LPC)	205
4. APPENDIX 4 : ABBREVIATIONS	206

1. INTRODUCTION

The safety of air transportation is a joint effort, regulated by the State on one hand, and practiced by the manufacturers, airlines and Air Traffic Controllers (ATC), on the other hand. The State is responsible for the supervision of civil aviation, to ensure that a high safety standard is maintained throughout the industry, and its primary means of enforcement is via the establishment and administration of written regulations. The control process encompasses a fixed set of rules to secure that all aircraft respect a minimum level of performance, which thereby leads to the definition of limitations.

The "State administration" generally implies the civil aviation authority, which corresponds to the aircraft's country of registration. In the United States, for example, this role is devoted to the Federal Aviation Administration (**FAA**), whereas in France, it is the "Direction Générale de l'Aviation Civile" (**DGAC**).

Every country has its own regulations, but the international aspect of air transportation takes into account the worldwide application of common rules. The International Civil Aviation Organization (**ICAO**) was therefore created in 1948, to provide a **supranational council**, to assist in defining the international minimum recommended standards. The Chicago Convention was signed on December 7, 1944, and has become the legal foundation for civil aviation worldwide.

Although it is customary for each country to adopt the main airworthiness standards defined in conjunction with aircraft manufacturers (USA, Europe, Canada, etc.), every country has its own set of operational regulations. For instance, some countries (mainly European) have adopted JAR-OPS 1, while some others follow the US FAR 121.

The "field of limitations" is therefore dependent upon an amalgamation of the following two realms:

- **Airworthiness:** Involving the aircraft's design (limitations, performance data etc...), in relation to **JAR 25** or **FAR 25**.
- **Operations:** Involving the technical operating rules (takeoff and landing limitations, fuel planning, etc...), in relation to **JAR-OPS 1** or **FAR 121**.

Both airworthiness and operational regulations exist for all aircraft types. This brochure addresses "large aircraft", which means aircraft with a maximum takeoff weight exceeding 5,700 kg. Airbus performance documentation is clearly divided into the two above-mentioned categories: Airworthiness and Operations.

- **Airworthiness:** The Airplane Flight Manual (**AFM**) is associated to the airworthiness certificate and contains certified performance data in compliance with JAR/FAR25.

- **Operations:** The Flight Crew Operating Manual (**FCOM**) can be viewed as the **AOM** (aircraft-related portion of the Operations Manual), which contains all the necessary limitations, procedures and performance data for aircraft operation.

The following table (Table 1) illustrates the large aircraft regulatory basis:

	ICAO	EUROPE (JAA)	USA (FAA)
Airworthiness	Annex 8 to the Chicago Convention	JAR ¹ 25	FAR ² part 25
Operating Rules	Annex 6 to the Chicago Convention	JAR-OPS1	FAR part 121

Table 1: Large Aircraft Requirements

All aircraft of the Airbus family are JAR 25 and/or FAR 25 certified. On the other hand, compliance with the operating rules remains under the airline’s responsibility.

This **brochure** is designed to address three different aspects of **aircraft performance**:

- The **physical aspect** : This brochure provides reminders on flight mechanics, aerodynamics, altimetry, influence of external parameters on aircraft performance, flight optimization concepts...
- The **regulatory aspect** : Description of the main **JAR and FAR** certification and operating rules, leading to the establishment of limitations. For a clear understanding, regulatory articles are quoted to assist in clarifying a given subject. In such cases, the text is written in italics and the article references are clearly indicated to the reader.
- The **operational aspect** : Description of operational methods, aircraft computer logics, operational procedures, pilot’s actions...

1 JAR: The Joint Airworthiness Requirements are under the European authority called the Joint Aviation Authority (JAA).

2 FAR: The Federal Aviation Regulations are under the US authority called the Federal Aviation Administration (FAA).

A. GENERAL

1. THE INTERNATIONAL STANDARD ATMOSPHERE (ISA)

1.1. Standard Atmosphere Modeling

The atmosphere is a gaseous envelope surrounding the earth. Its characteristics are different throughout the world. For this reason, it is necessary to adopt an average set of conditions called the **International Standard Atmosphere (ISA)**.

1.1.1. Temperature Modeling

The following diagram (Figure A1) illustrates the temperature variations in the standard atmosphere:

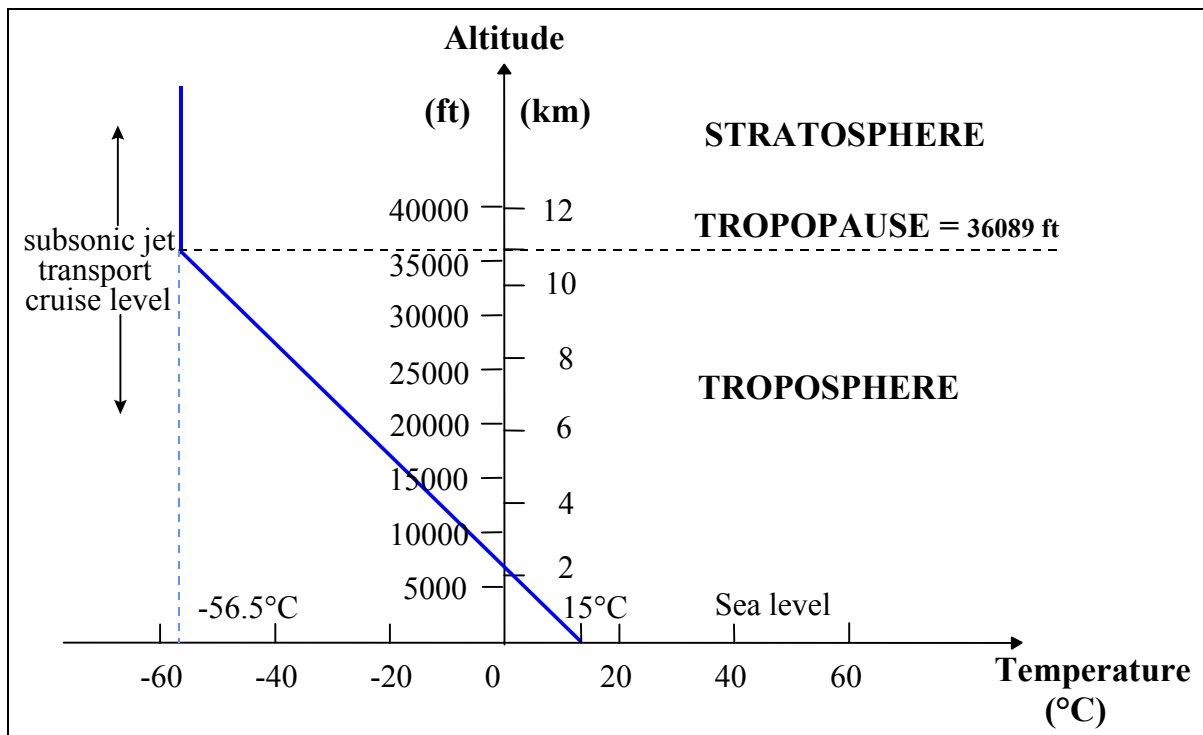

Figure A1: ISA temperature

The international reference is based on a sea-level temperature of 15°C at a pressure of 1013.25 hPa¹. The standard density of the air at sea level is 1.225 kg/m³.

¹ 1013.25 hPa is equal to 29.92 in Hg, 'hPa' meaning hectoPascal and 'in Hg' inches of mercury.

Temperature decreases with altitude at a constant rate of $-6.5^{\circ}\text{C}/1000\text{m}$ or $-1.98^{\circ}\text{C}/1000\text{ft}$ up to the tropopause. The standard tropopause altitude is 11,000 m or 36,089 feet.

From the tropopause upward, the temperature remains at a constant value of -56.5°C .

Therefore, the air which is considered as a perfect gas in the ISA model presents the following characteristics:

- **At Mean Sea Level (MSL):**

$$\text{ISA temperature} = T_0 = +15^{\circ}\text{C} = 288.15 \text{ K}$$

- **Above MSL and below the tropopause (36,089 feet):**

$$\text{ISA temperature } (^{\circ}\text{C}) = T_0 - 1.98 \times [\text{Alt}(\text{feet})/1000]$$

For a quick determination of the standard temperature at a given altitude, the following approximate formula can be used:

$$\text{ISA temperature } (^{\circ}\text{C}) = 15 - 2 \times [\text{Alt}(\text{feet})/1000]$$

- **Above the tropopause (36,089 feet):**

$$\text{ISA temperature} = -56.5^{\circ}\text{C} = 216.65 \text{ K}$$

This ISA model is used as a reference to compare real atmospheric conditions and the corresponding engine/aircraft performance. The atmospheric conditions will therefore be expressed as **ISA +/- Δ ISA** at a given flight level.

Example:

Let's consider a flight in the following conditions:

Altitude = 33,000 feet

Actual Temperature = -41°C

The standard temperature at 33,000 feet is : $\text{ISA} = 15 - 2 \times 33 = -51^{\circ}\text{C}$, whereas the actual temperature is -41°C , i.e. 10°C above the standard.

Conclusion: The flight is operated in **ISA+10** conditions

1.1.2. Pressure Modeling

To calculate the standard pressure **P** at a given altitude, the following assumptions are made:

- Temperature is standard, versus altitude.
- Air is a perfect gas.

The altitude obtained from the measurement of the pressure is called **pressure altitude (PA)**, and a standard (ISA) table can be set up (table A1).

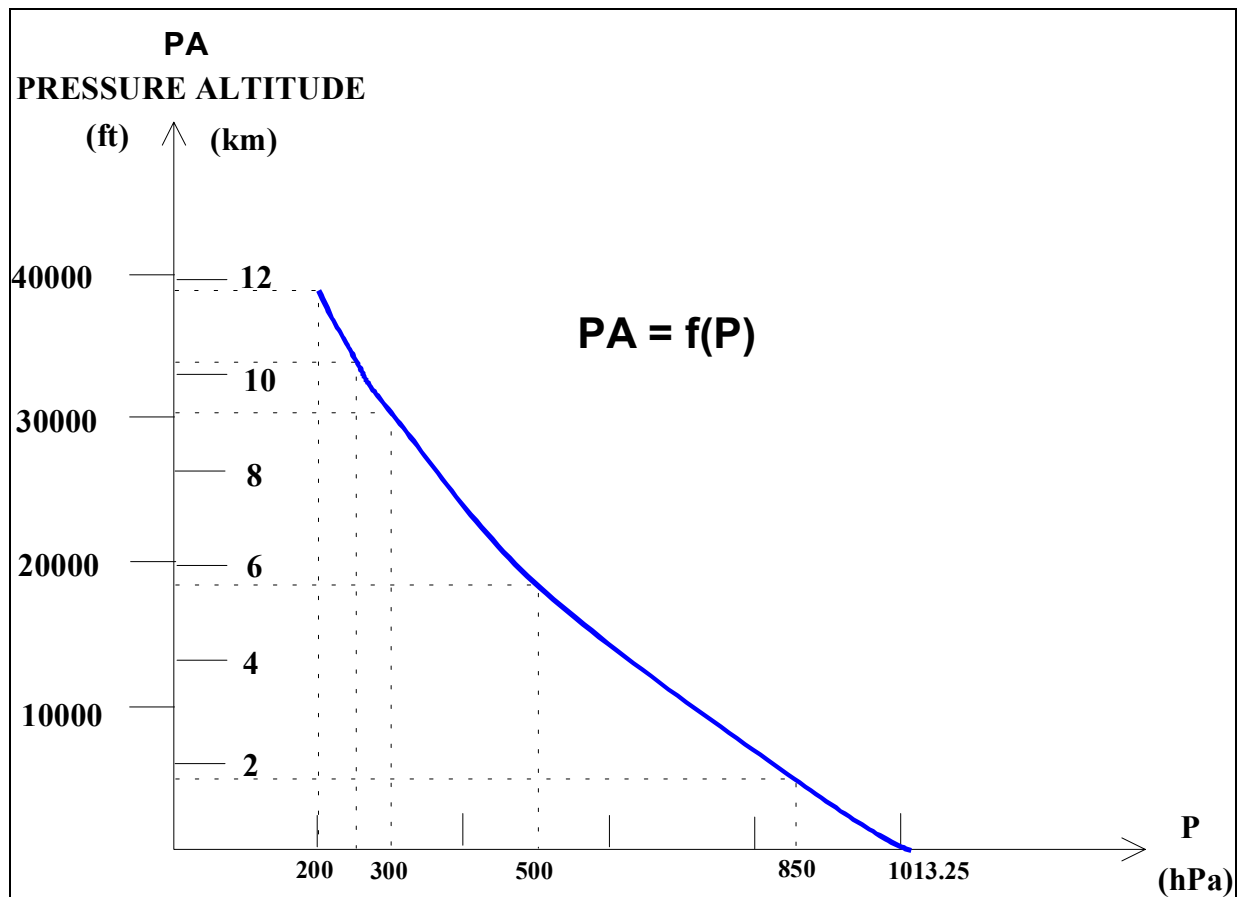

Figure A2: Pressure Altitude function of Pressure

Pressure (hPa)	Pressure altitude (PA)		FL= PA/100
	(feet)	(meters)	
200	38661	11784	390
250	34000	10363	340
300	30066	9164	300
500	18287	5574	180
850	4813	1467	50
1013	0	0	0

Table A1: Example of Tabulated Pressure Altitude Values

Assuming a volume of air in static equilibrium, the aerostatic equation gives:

$$dP = - \rho g dh$$

With ρ = air density at an altitude h
 g = gravity acceleration (9.80665 m/s²)
 dh = height of the volume unit
 dP = pressure variation on dh

The perfect gas equation gives:

$$\frac{P}{\rho} = RT$$

With R = universal gas constant (287.053 J/kg/K)

Consequently:

- **At Mean Sea Level (MSL):**

$$P_0 = 1013.25 \text{ hPa}$$

- **Above MSL and below the tropopause (36,089 feet):**

$$P = P_0 \left(1 - \frac{\alpha}{T_0} h\right)^{\frac{g_0}{\alpha R}}$$

With $P_0 = 1013.25 \text{ hPa}$ (standard pressure at sea level)
 $T_0 = 288.15 \text{ K}$ (standard temperature at sea level)
 $\alpha = 0.0065 \text{ }^\circ\text{C/m}$
 $g_0 = 9.80665 \text{ m/s}^2$
 $R = 287.053 \text{ J/kg/K}$
 h = Altitude (m)

Note: For low altitudes, a reduction of **1 hPa** in the pressure approximately corresponds to a pressure altitude increase of **28 feet**.

- **Above the tropopause (36,089 feet):**

$$P = P_1 e^{\frac{-g_0(h-h_1)}{RT_1}}$$

With $P_1 = 226.32 \text{ hPa}$ (standard pressure at 11,000 m)
 $T_1 = 216.65 \text{ K}$ (standard temperature at 11,000 m)

$$\begin{aligned}
 h_1 &= 11,000 \text{ m} \\
 g_0 &= 9.80665 \text{ m/s}^2 \\
 R &= 287.053 \text{ J/kg/K} \\
 h &= \text{Altitude (m)}
 \end{aligned}$$

1.1.3. Density Modeling

To calculate the standard density ρ at a given altitude, the air is assumed to be a perfect gas. Therefore, at a given altitude, the standard density ρ (kg/m^3) can be obtained as follows:

$$\rho = \frac{P}{RT}$$

with $R = \text{universal gas constant (287.053 J/kg/K)}$
 P in Pascal
 T in Kelvin

- **At Mean Sea Level (MSL):**

$$\rho_0 = 1.225 \text{ kg/m}^3$$

1.2. International Standard Atmosphere (ISA) Table

The International Standard Atmosphere parameters (temperature, pressure, density) can be provided as a function of the altitude under a tabulated form, as shown in Table A2:

ALTITUDE (Feet)	TEMP. (°C)	PRESSURE			PRESSURE RATIO $\delta = P/P_0$	DENSITY $\sigma = \rho/\rho_0$	Speed of sound (kt)	ALTITUDE (meters)
		hPa	PSI	In.Hg				
40 000	- 56.5	188	2.72	5.54	0.1851	0.2462	573	12 192
39 000	- 56.5	197	2.58	5.81	0.1942	0.2583	573	11 887
38 000	- 56.5	206	2.99	6.10	0.2038	0.2710	573	11 582
37 000	- 56.5	217	3.14	6.40	0.2138	0.2844	573	11 278
36 000	- 56.3	227	3.30	6.71	0.2243	0.2981	573	10 973
35 000	- 54.3	238	3.46	7.04	0.2353	0.3099	576	10 668
34 000	- 52.4	250	3.63	7.38	0.2467	0.3220	579	10 363
33 000	- 50.4	262	3.80	7.74	0.2586	0.3345	581	10 058
32 000	- 48.4	274	3.98	8.11	0.2709	0.3473	584	9 754
31 000	- 46.4	287	4.17	8.49	0.2837	0.3605	586	9 449
30 000	- 44.4	301	4.36	8.89	0.2970	0.3741	589	9 144
29 000	- 42.5	315	4.57	9.30	0.3107	0.3881	591	8 839
28 000	- 40.5	329	4.78	9.73	0.3250	0.4025	594	8 534
27 000	- 38.5	344	4.99	10.17	0.3398	0.4173	597	8 230
26 000	- 36.5	360	5.22	10.63	0.3552	0.4325	599	7 925
25 000	- 34.5	376	5.45	11.10	0.3711	0.4481	602	7 620
24 000	- 32.5	393	5.70	11.60	0.3876	0.4642	604	7 315
23 000	- 30.6	410	5.95	12.11	0.4046	0.4806	607	7 010
22 000	- 28.6	428	6.21	12.64	0.4223	0.4976	609	6 706
21 000	- 26.6	446	6.47	13.18	0.4406	0.5150	611	6 401
20 000	- 24.6	466	6.75	13.75	0.4595	0.5328	614	6 096
19 000	- 22.6	485	7.04	14.34	0.4791	0.5511	616	5 791
18 000	- 20.7	506	7.34	14.94	0.4994	0.5699	619	5 406
17 000	- 18.7	527	7.65	15.57	0.5203	0.5892	621	5 182
16 000	- 16.7	549	7.97	16.22	0.5420	0.6090	624	4 877
15 000	- 14.7	572	8.29	16.89	0.5643	0.6292	626	4 572
14 000	- 12.7	595	8.63	17.58	0.5875	0.6500	628	4 267
13 000	- 10.8	619	8.99	18.29	0.6113	0.6713	631	3 962
12 000	- 8.8	644	9.35	19.03	0.6360	0.6932	633	3 658
11 000	- 6.8	670	9.72	19.79	0.6614	0.7156	636	3 353
10 000	- 4.8	697	10.10	20.58	0.6877	0.7385	638	3 048
9 000	- 2.8	724	10.51	21.39	0.7148	0.7620	640	2 743
8 000	- 0.8	753	10.92	22.22	0.7428	0.7860	643	2 438
7 000	+ 1.1	782	11.34	23.09	0.7716	0.8106	645	2 134
6 000	+ 3.1	812	11.78	23.98	0.8014	0.8359	647	1 829
5 000	+ 5.1	843	12.23	24.90	0.8320	0.8617	650	1 524
4 000	+ 7.1	875	12.69	25.84	0.8637	0.8881	652	1 219
3 000	+ 9.1	908	13.17	26.82	0.8962	0.9151	654	914
2 000	+ 11.0	942	13.67	27.82	0.9298	0.9428	656	610
1 000	+ 13.0	977	14.17	28.86	0.9644	0.9711	659	305
0	+ 15.0	1013	14.70	29.92	1.0000	1.0000	661	0
- 1 000	+ 17.0	1050	15.23	31.02	1.0366	1.0295	664	- 305

Table A2: International Standard Atmosphere (ISA)

2. ALTIMETRY PRINCIPLES

2.1. General

An altimeter (Figure A4) is a manometer, which is calibrated following standard pressure and temperature laws. The ambient atmospheric pressure is the only input parameter used by the altimeter.

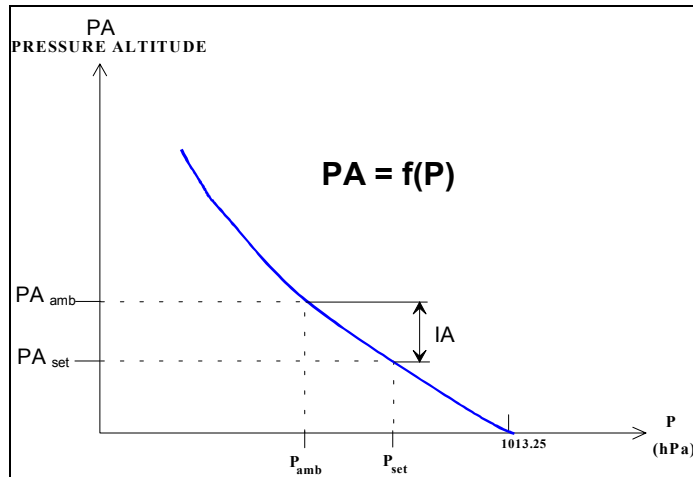

Figure A3: Ambient Pressure and Pressure Setting

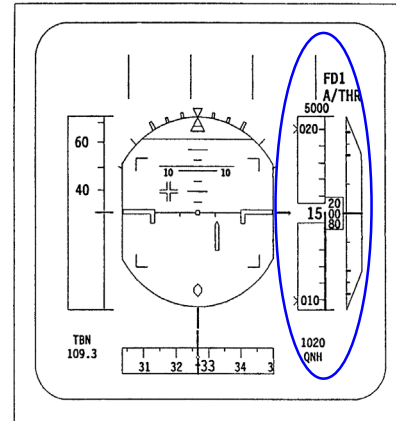

Figure A4: Altimeter Function on PFD

Assuming the conditions are standard, the “Indicated Altitude” (IA) is the vertical distance between the following two pressure surfaces (Figure A3):

- The **pressure surface** at which the **ambient pressure** is measured (actual aircraft’s location), and
- The **reference pressure surface**, corresponding to the pressure selected by the pilot through the altimeter’s **pressure setting** knob.

$$IA = f(P_{amb}) - f(P_{set})$$

$$IA = PA_{amb} - PA_{set}$$

2.2. Definitions

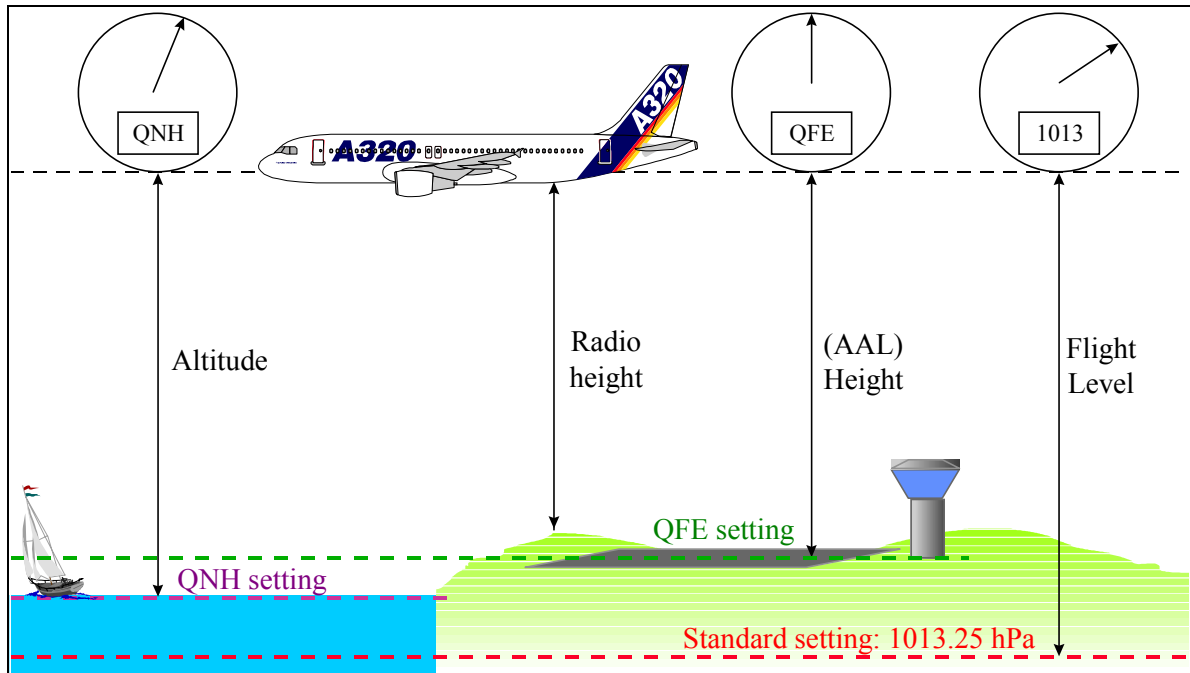

Figure A5: QNH and Pressure Altitude

The pressure setting and the indicated altitude move in the same direction: Any increase in the pressure setting leads to an increase in the corresponding Indicated Altitude (IA).

The aim of altimetry is to ensure relevant margins, above ground and between aircraft. For that purpose, different operational pressure settings can be selected through the altimeter's pressure setting knob (Figure A5):

- **QFE** is the pressure at the airport reference point. With the QFE setting, the altimeter indicates the altitude above the airport reference point (if the temperature is standard).

Note: The QFE selection is often provided as an option on Airbus aircraft.

- **QNH** is the Mean Sea Level pressure. The QNH is calculated through the measurement of the pressure at the airport reference point moved to Mean Sea Level, assuming the standard pressure law. With the QNH setting, the altimeter indicates the altitude above Mean Sea Level (if temperature is standard). Consequently, at the airport level in ISA conditions, the altimeter indicates the topographic altitude of the terrain.

- **Standard** corresponds to 1013 hPa. With the standard setting, the altimeter indicates the altitude above the 1013 hPa isobaric surface (if temperature is standard). The aim is to provide a vertical separation between aircraft while getting rid of the local pressure variations throughout

the flight. After takeoff, crossing a given altitude referred to as Transition Altitude, the standard setting is selected.

- The **Flight Level** corresponds to the Indicated Altitude in feet divided by 100, provided the standard setting is selected.
- The **Transition Altitude** is the indicated altitude above which the standard setting must be selected by the crew.
- The **Transition Level** is the first available flight level above the transition altitude.

The change between the QNH setting and Standard setting occurs at the transition altitude when climbing, and at the transition level when descending (Figure A6).

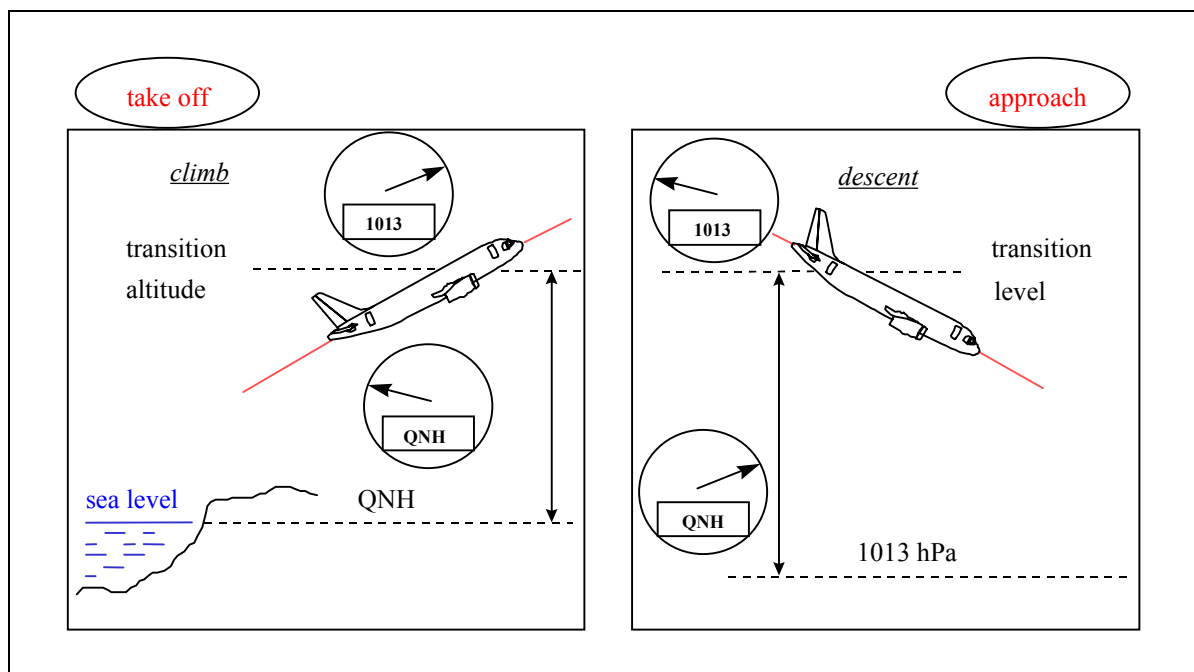

Figure A6: Transition Altitude and Transition Level

The transition altitude is generally given on the Standard Instrument Departure (SID) charts, whereas the transition level is usually given by the Air Traffic Control (ATC).

2.3. Effects of Altimeter Setting and Temperature

The true altitude of an aircraft is rarely the same as the indicated altitude, when the altimeter setting is 1013 hPa. This is mainly due to the fact that the pressure at sea level is generally different from 1013 hPa, and/or that the temperature is different from ISA.

2.3.1. Altimeter Setting Correction

In case of ISA temperature conditions, and a standard altimetric setting, the aircraft true altitude can be obtained from the indicated altitude provided the local QNH is known.

$$\text{True altitude} = \text{Indicated altitude} + 28 \times (\text{QNH}_{[\text{hPa}]} - 1013)$$

2.3.2. Temperature Correction

Flying at a given indicated altitude, **the true altitude increases with the temperature** (Figure A7). The relationship between true altitude and indicated altitude can be approximated as follows:

$$TA = IA \frac{T}{T_{ISA}}$$

TA = True altitude

IA = Indicated altitude

T = Actual temperature (in Kelvin)

T_{ISA} = Standard temperature (in Kelvin)

An example is provided in **Appendix 1** of this manual.

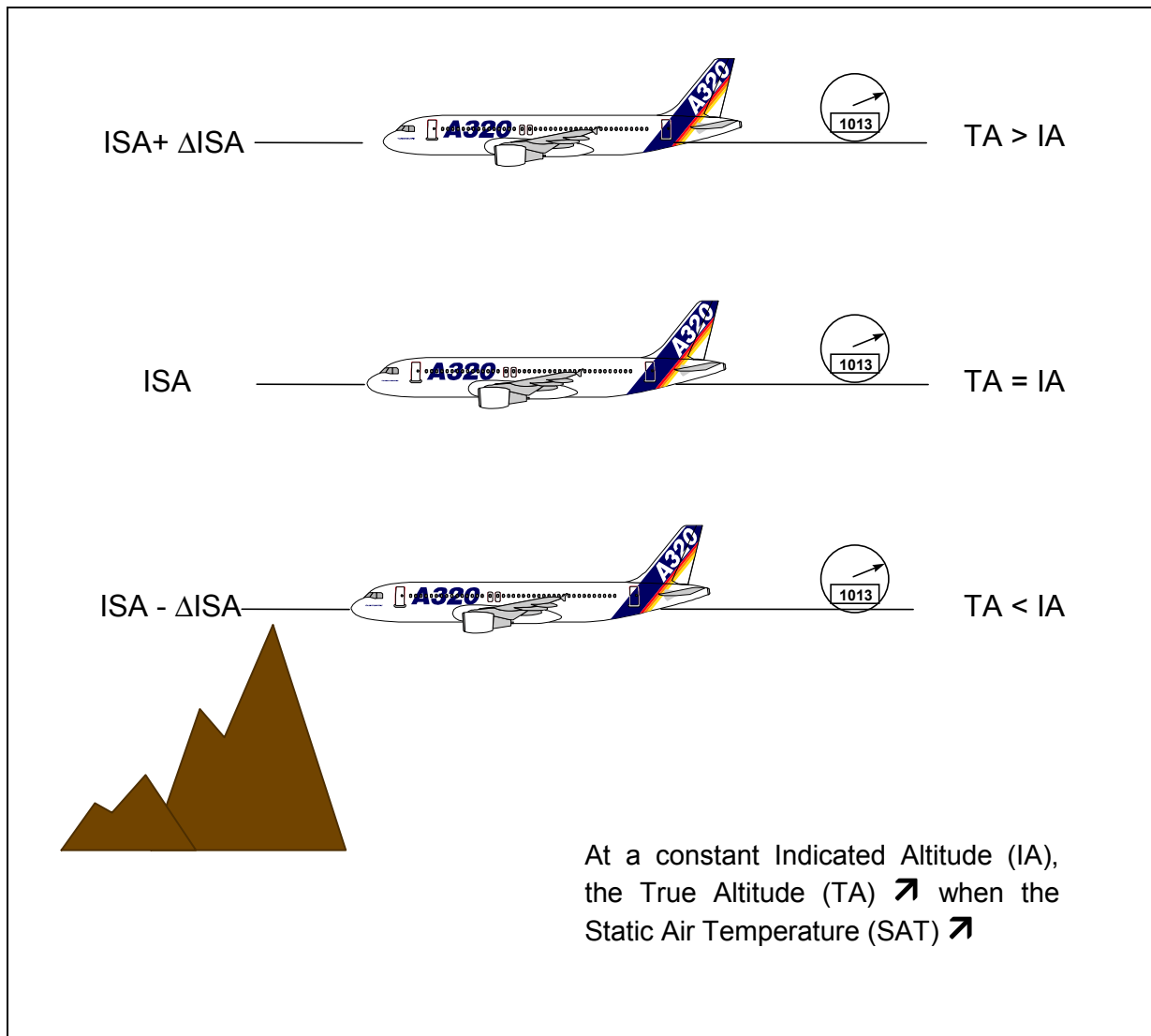

Figure A7: Temperature effect on True Altitude, for a constant Indicated Altitude

Conclusion:*If the temperature is higher, you fly higher.**If the temperature is lower, you fly lower.*

Temperature correction is important, when flying a departure or arrival procedure in very low temperature conditions. For that purpose, the following table (Table A3) is proposed in the FCOM:

A319/320/321 FLIGHT CREW OPERATING MANUAL	IN FLIGHT PERFORMANCE	3.05.05	P 6
	OPERATING DATA	SEQ 001	REV 24

ALTITUDE TEMPERATURE CORRECTION

FOR HIGH ALTITUDE USE

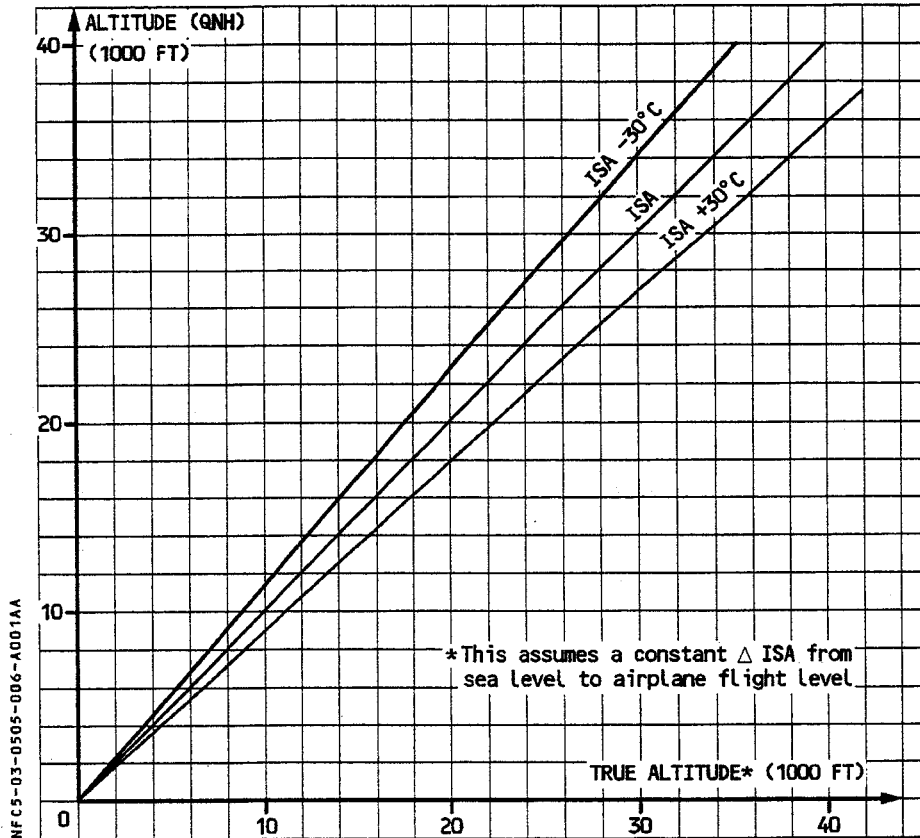

FOR LOW ALTITUDE USE

QNH ALTITUDE MINUS TERRAIN ELEVATION (FT) →		ΔZ CORRECTION (FT)					
		500	1000	1500	2000	2500	3000
ΔISA	- 10 °C	- 17	- 34	- 51	- 68	- 85	- 102
	- 20 °C	- 35	- 70	- 105	- 140	- 175	- 210
	- 30 °C	- 52	- 104	- 156	- 208	- 260	- 312
	- 40 °C	- 70	- 140	- 210	- 280	- 350	- 420

TRUE ALTITUDE = QNH ALTITUDE + ΔZ
 Note: A constant ΔISA from ground to airplane level has been assumed.

Table A3: True Altitude Correction versus Temperature

3. OPERATING SPEEDS

Different speed types are used to operate an aircraft. Some of them enable the crew to manage the flight while maintaining some margins from critical areas, whereas others are mainly used for navigational and performance optimization purposes. This is why the following sections propose a review of the different speed types that are used in aeronautics.

3.1. Calibrated Air Speed (CAS)

The Calibrated Air Speed (CAS) is obtained from the difference between the total pressure (P_t) and the static pressure (P_s). This difference is called dynamic pressure (q). As the dynamic pressure cannot be measured directly, it is obtained thanks to two probes (Figure A8).

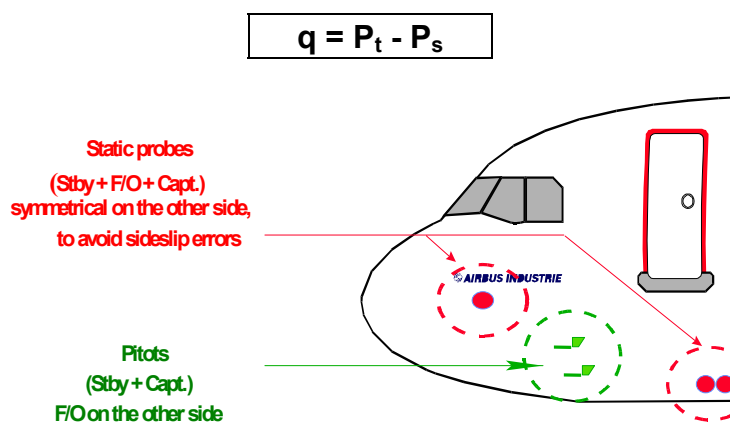

Figure A8: Pitot Tube and Static Probes

To obtain the **total pressure** P_t , airflow is stopped by means of a forward-facing tube, called the pitot tube (Figure A9), which measures the impact pressure. This pressure measurement accounts for the ambient pressure (static aspect) at the given flight altitude plus the aircraft motion (dynamic aspect).

The **static pressure** P_s is measured by means of a series of symmetrical static probes perpendicular to the airflow. This measurement represents the ambient pressure at the given flight altitude (static aspect).

$$\text{CAS} = f(P_t - P_s) = f(q)$$

Flying at a constant CAS during a climb phase enables the aerodynamic effect to remain the same as at sea level and, consequently, to eliminate speed variations.

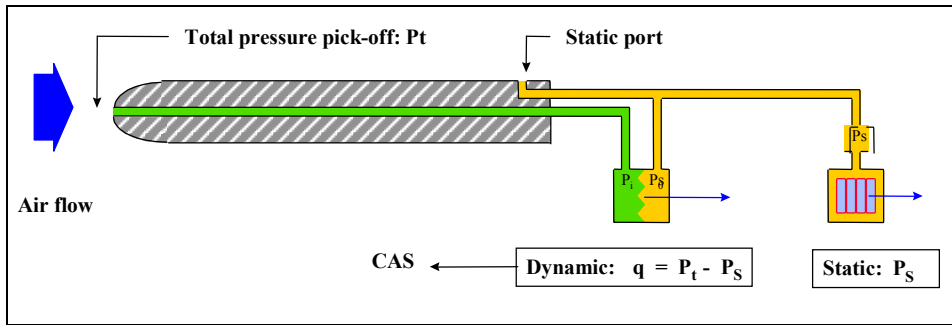

Figure A9: CAS Determination Process

3.2. Indicated Air Speed (IAS)

The Indicated Air Speed (IAS) is the speed indicated by the airspeed indicator. Whatever the flight conditions, if the pressure measurement were accurate, then the IAS should ideally be equal to the CAS. Nevertheless, depending on the aircraft angle of attack, the flaps configuration, the ground proximity (ground effect or not), the wind direction and other influent parameters, some measurement errors are introduced, mainly on the static pressure. This leads to a small difference between the CAS and the IAS values. This difference is called instrumental correction or antenna error (K_i).

$$IAS = CAS + K_i$$

3.3. True Air Speed (TAS)

An aircraft in flight moves in an air mass, which is itself in motion compared to the earth. The True Air Speed (TAS) represents the aircraft speed in a moving reference system linked to this air mass, or simply the aircraft speed in the airflow. It can be obtained from the CAS, using the air density (ρ) and a compressibility correction (K).

$$TAS = \sqrt{(\rho_0/\rho)} K CAS$$

3.4. Ground Speed (GS)

The ground speed (GS) represents the aircraft speed in a fixed ground reference system. It is equal to the TAS corrected for the wind component (Figure A10).

$$Ground\ Speed = True\ Air\ Speed + Wind\ Component$$

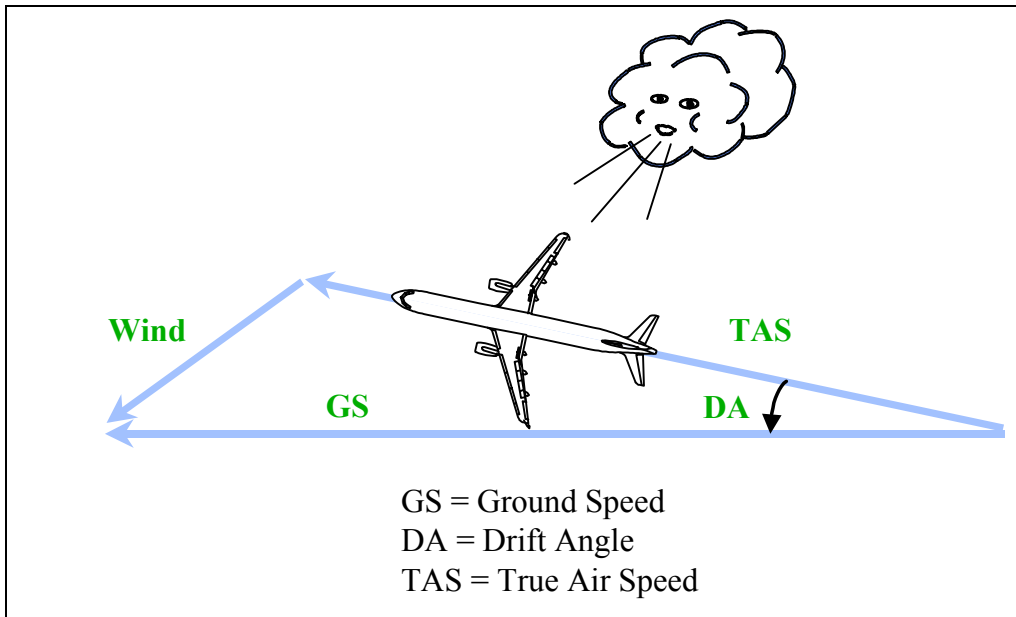

Figure A10: Ground Speed and Drift Angle

3.5. Mach Number

The Mach Number is a comparison between the TAS and the speed of sound.

$$M = \frac{TAS}{a}$$

With TAS = True Air Speed

a = The speed of sound at the flight altitude

The speed of sound in knots is:

$$a(\text{kt}) = 39 \sqrt{SAT(\text{K})}$$

With SAT = Static Air Temperature (ambient temperature) in Kelvin

The **speed of sound is solely dependent on temperature**. Consequently, the Mach number can be expressed as follows:

$$M = \frac{TAS (\text{kt})}{39 \sqrt{273 + SAT(^{\circ}\text{C})}}$$

Flying at a given Mach number in the troposphere: When the pressure altitude increases, the SAT decreases and thus the True Air Speed (TAS). Or :

higher \Rightarrow slower

P_t and P_s , respectively measured by the aircraft pitot tube and static probes, are also used to compute the Mach number. Therefore,

$$M = f\left(\frac{P_t - P_s}{P_s}\right) = f\left(\frac{q}{P_s}\right)$$

The TAS indicated on the navigation display of modern aircraft is then obtained from the Mach number:

$$TAS(Kt) = 39M \sqrt{273 + SAT(^{\circ}C)}$$

3.6. True Air Speed (TAS) Variations

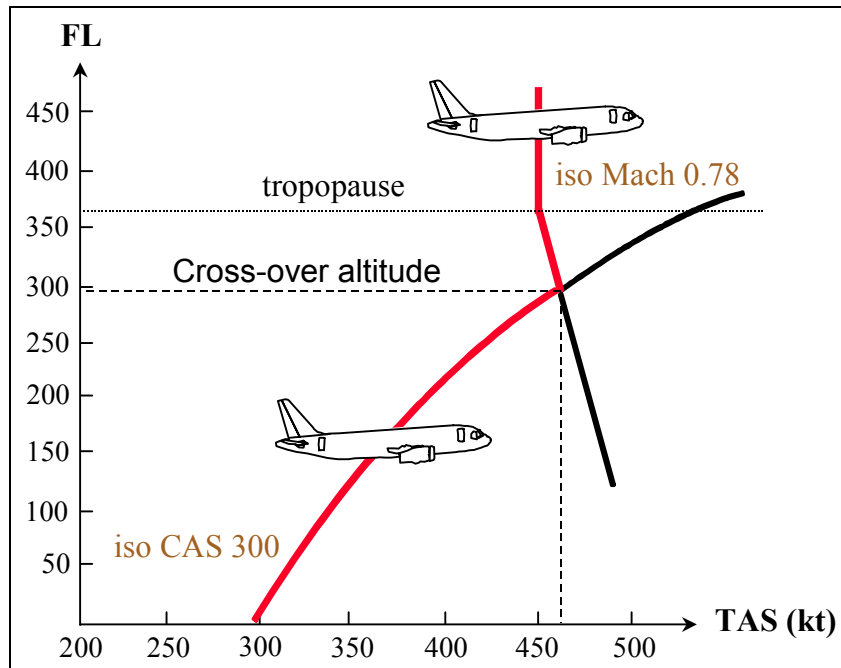

Figure A11: True Air Speed Variations – Climb profile 300 Kt / M0.78

The above graph (Figure A11) illustrates the TAS variations as a function of the pressure altitude for a climb at constant CAS (300 knots) and constant Mach (M0.78).

The altitude at which a given CAS is equal to a given Mach number is called the **cross-over altitude**.

4. FLIGHT MECHANICS

For a flight at constant speed in level flight, the drag force must balance the engine thrust.

As a general rule, when engine thrust is higher than drag, the aircraft can use this excess thrust to accelerate and/or climb. On the other hand, when the thrust is insufficient to compensate for drag, the aircraft is forced to decelerate and/or descend.

In flight, four forces are applied to an aircraft : Thrust, drag, lift and weight. If the aircraft is in steady level flight, the following balance is obtained (Figure A12):

- The thrust for steady level flight (T) is equal to drag ($D = \frac{1}{2} \rho S V^2 C_D$),
- Weight (mg) is equal to lift ($L = \frac{1}{2} \rho S V^2 C_L$).

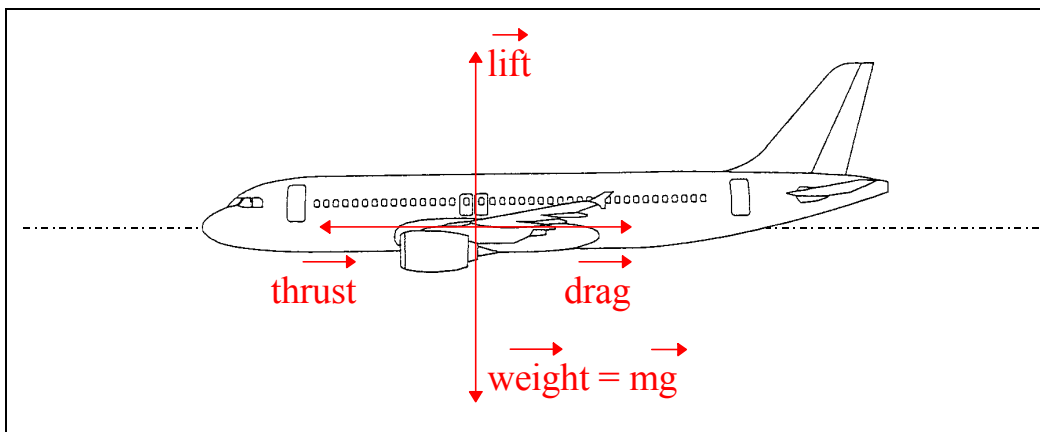

Figure A12: Balance of Forces for Steady Level Flight

4.1.1.1. Standard Lift Equation

$$\text{Weight} = mg = \frac{1}{2} \rho S (\text{TAS})^2 C_L \quad (1)$$

With m = Aircraft mass
 g = Gravitational acceleration
 ρ = Air density
 S = Wing area
 C_L = lift coefficient

The lift coefficient, C_L , is a function of the angle of attack (α), the Mach number (M), and the aircraft configuration.

4.1.1.2. Standard Drag Equation

$$\text{Thrust} = \frac{1}{2} \rho S (\text{TAS})^2 C_D \quad (2)$$

With C_D = Drag coefficient

The drag coefficient, C_D , is a function of the angle of attack (α), the Mach number (M) and the aircraft configuration.

4.1.1.3. Other Formulas

- **As a function of the Mach number:**

Lift and drag equations may be expressed with the Mach number M. As a result, the equations are:

$$\text{Weight} = 0.7 P_s S M^2 C_L \quad (3)$$

$$\text{Thrust} = 0.7 P_s S M^2 C_D \quad (4)$$

With P_s = Static Pressure

- **As a function of P_0 :**

The pressure ratio δ is introduced into the lift and drag equations:

$$\delta = \frac{P_s}{P_0} \quad (5)$$

With P_0 = Pressure at Sea Level
 P_s = Pressure at Flight Level

Therefore, the following equations are independent of pressure altitude:

$$\frac{\text{Weight}}{\delta} = 0.7 P_0 S M^2 C_L \quad (6)$$

$$\frac{\text{Thrust}}{\delta} = 0.7 P_0 S M^2 C_D \quad (7)$$

B. AIRCRAFT LIMITATIONS

1. FLIGHT LIMITATIONS

During aircraft operation, the airframe must endure the forces generated from such sources as engine(s), aerodynamic loads, and inertial forces. In still air, when the aircraft is maneuvering, or during in flight turbulence, load factors (**n**) appear and thereby increase loads on the aircraft. This leads to the establishment of **maximum weights** and **maximum speeds**.

1.1. Limit Load Factors

JAR 25.301 Subpart C
 JAR 25.303 Subpart C
 JAR 25.305 Subpart C
 JAR 25.307 Subpart C
 JAR 25.321 Subpart C
 JAR 25.1531 Subpart G

FAR 25.301 Subpart C
 FAR 25.303 Subpart C
 FAR 25.305 Subpart C
 FAR 25.307 Subpart C
 FAR 25.321 Subpart C
 FAR 25.1531 Subpart G

“JAR/FAR 25.301 Loads

(a) Strength requirements are specified in terms of limit loads (the maximum loads to be expected in service) and ultimate loads (limit loads multiplied by prescribed factors of safety). Unless otherwise provided, prescribed loads are limit loads.”

“JAR/FAR 25.321 Flight Loads

(a) **Flight Load Factors represent the ratio of the aerodynamic force component (acting normal to the assumed longitudinal axis of the airplane) to the weight of the airplane.** A positive load factor is one in which the aerodynamic force acts upward with respect to the airplane.”

$$n_z = \frac{\text{Lift}}{\text{Weight}}$$

Except when the lift force is equal to the weight and $n_z=1$ (for instance in straight and level flight), **the aircraft's apparent weight is different from its real weight (mg):**

$$\text{Apparent weight} = n_z \cdot m \cdot g = \text{Lift}$$

In some cases, the load factor is greater than 1 (turn, resource, turbulence). In other cases, it may be less than 1 (rough air). The aircraft's structure is obviously designed to resist such load factors, up to the limits imposed by regulations.

Consequently, load factor limits are defined so that an aircraft can operate within these limits without suffering permanent distortion of its structure. The ultimate loads, leading to rupture, are generally 1.5 times the load factor limits.

*“JAR/FAR 25.1531 Manoeuvring flight load factors
Load factor limitations, not exceeding the positive limit load factors determined from the manoeuvring diagram in section 25.333 (b) must be established.”*

For all Airbus types, the flight maneuvering load acceleration limits are established as follows:

Clean configuration.....	-1g ≤ n ≤ +2.5g
Slats extended.....	0g ≤ n ≤ +2g

1.2. Maximum Speeds

<i>JAR 25.1501 Subpart G</i>	<i>FAR 25.1501 Subpart G</i>
------------------------------	------------------------------

*“JAR/FAR 25.1501 General
(a) Each operating limitation specified in sections 25.1503 to 25.1533 and other limitations and information necessary for safe operation must be established.”*

<i>JAR 25.1503 Subpart G</i>	<i>FAR 25.1503 Subpart G</i>
<i>JAR 25.1505 Subpart G</i>	<i>FAR 25.1505 Subpart G</i>
<i>JAR 25.1507 Subpart G</i>	<i>FAR 25.1507 Subpart G</i>
<i>JAR 25.1511 Subpart G</i>	<i>FAR 25.1511 Subpart G</i>
<i>JAR 25.1515 Subpart G</i>	<i>FAR 25.1515 Subpart G</i>
<i>JAR 25.1517 Subpart G</i>	<i>FAR 25.1517 Subpart G</i>

*“JAR/FAR 25.1503 Airspeed Limitations: General
When airspeed limitations are a function of weight, weight distribution, altitude, or Mach number, the limitations corresponding to each critical combination of these factors must be established.”*

OPERATING LIMIT SPEED	DEFINITIONS	SPEED VALUE EXAMPLES FOR THE A320-200
V_{MO}/M_{MO} Maximum operating limit speed	JAR / FAR 25.1505 Subpart G V _{MO} or M _{MO} are the speeds that may not be deliberately exceeded in any regime of flight (climb, cruise, or descent).	V_{MO} = 350 kt (IAS) M_{MO} = M0.82
V_F Flap extended speeds	JAR / FAR 25.1511 Subpart G V _F must be established so that it does not exceed the design flap speed.	CONF1 230 kt CONF1+F 215 kt CONF2 200 kt CONF3 185 kt CONFULL 177 kt
V_{LO} / V_{LE} Landing gear speeds	JAR / FAR 25.1515 Subpart G <u>V_{LO}: Landing Gear Operating Speed</u> V _{LO} may not exceed the speed at which it is safe both to extend and to retract the landing gear. If the extension speed is not the same as the retraction speed, the two speeds must be designated as V _{LO(EXT)} and V _{LO(RET)} respectively. JAR / FAR 25.1515 Subpart G <u>V_{LE}: Landing Gear Extended Speed.</u> V _{LE} may not exceed the speed at which it is safe to fly with the landing gear secured in the fully extended position.	V_{LO RET} (landing gear operating: retraction) 220 kt (IAS) V_{LO EXT} (landing gear operating: extension) 250 kt (IAS) V_{LE} (landing gear extended) 280 kt / M 0.67

1.3. Minimum Speeds

1.3.1. Minimum Control Speed on the Ground: V_{MCG}

JAR 25.149 Subpart B

FAR 25.149 Subpart B

“JAR/FAR 25.149 Minimum control speed

(e) V_{MCG}, the minimum control speed on the ground, is the calibrated airspeed during the take-off run, at which, when the critical engine is suddenly made inoperative, it is possible to maintain control of the aeroplane with the use of the primary aerodynamic controls alone (without the use of nose-wheel steering) to enable the take-off to be safely continued using normal piloting skill.

In the determination of V_{MCG} , assuming that the path of the aeroplane accelerating with all engines operating is along the centreline of the runway, its path from the point at which the critical engine is made inoperative to the point at which recovery to a direction parallel to the centreline is completed, may not deviate more than 30 ft laterally from the centreline at any point."

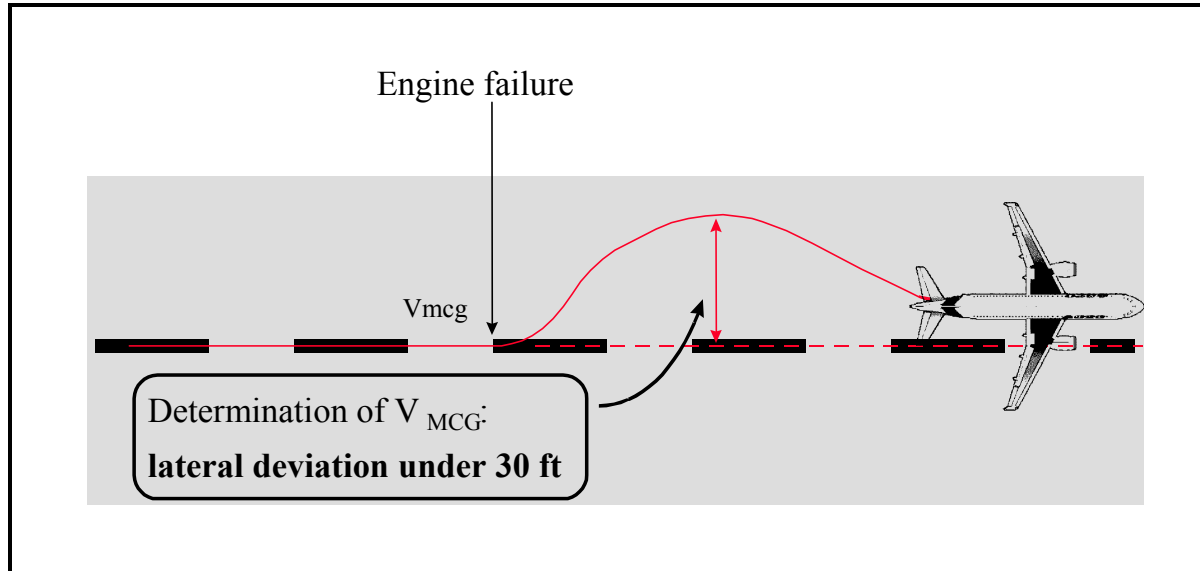

Figure B1: V_{MCG}

" V_{MCG} must be established, with:

- *The aeroplane in each take-off configuration or, at the option of the applicant, in the most critical take-off configuration;*
- *Maximum available take-off power or thrust on the operating engines;*
- *The most unfavourable centre of gravity;*
- *The aeroplane trimmed for take-off; and*
- *The most unfavourable weight in the range of take-off weights."*

1.3.2. Minimum Control Speed in the Air: V_{MCA}

JAR 25.149 Subpart B

FAR 25.149 Subpart B

"JAR/FAR 25.149 Minimum control speed

(b) $V_{MC[A]}$ is the calibrated airspeed, at which, when the critical engine is suddenly made inoperative, it is possible to maintain control of the aeroplane with that engine still inoperative, and maintain straight flight with an angle of bank of not more than 5 degrees.

(c) $V_{MC[A]}$ may not exceed $1.2 V_S$ with

- *Maximum available take-off power or thrust on the engines;*
- *The most unfavourable centre of gravity;*
- *The aeroplane trimmed for take-off;*
- *The maximum sea-level take-off weight*

- The aeroplane in the most critical take-off configuration existing along the flight path after the aeroplane becomes airborne, except with the landing gear retracted; and
- The aeroplane airborne and the ground effect negligible

(d) During recovery, the aeroplane may not assume any dangerous attitude or require exceptional piloting skill, alertness, or strength to prevent a heading change of more than 20 degrees.”

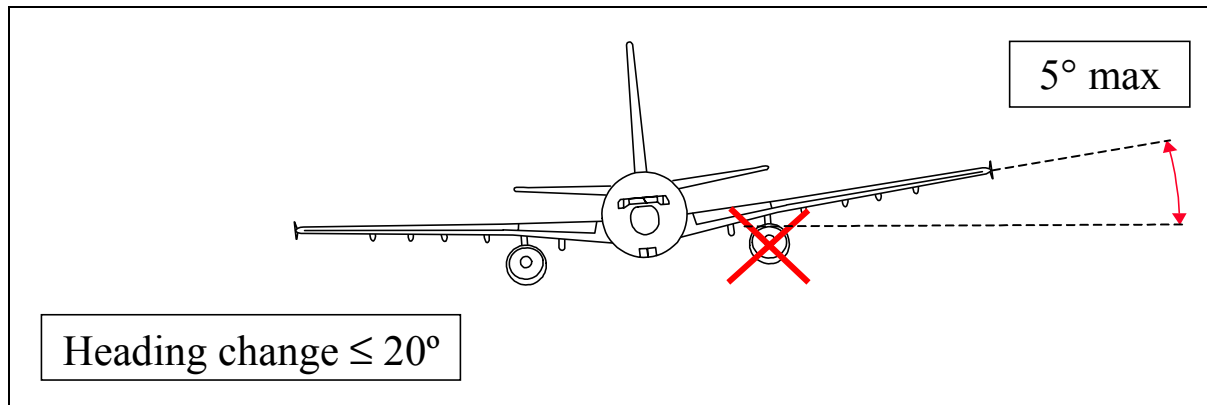

Figure B2: V_{MCA}

1.3.3. Minimum Control Speed during Approach and Landing: V_{MCL}

JAR 25.149 Subpart B

FAR 25.149 Subpart B

“JAR/FAR 25.149 Minimum control speed

(f) V_{MCL} , the minimum control speed during approach and landing with all engines operating, is the calibrated airspeed at which, when the critical engine is suddenly made inoperative, it is possible to maintain control of the aeroplane with that engine still inoperative, and maintain straight flight with an angle of bank of not more than 5°. V_{MCL} must be established with:

- The aeroplane in the most critical configuration (or, at the option of the applicant, each configuration) for approach and landing with all engines operating;
- The most unfavourable centre of gravity;
- The aeroplane trimmed for approach with all engines operating;
- The most unfavourable weight, or, at the option of the applicant, as a function of weight.
- Go-around thrust setting on the operating engines

(g) For aeroplanes with three or more engines, V_{MCL-2} , the minimum control speed during approach and landing with one critical engine inoperative, is the calibrated airspeed at which, when a second critical engine is suddenly made inoperative, it is possible to maintain control of the aeroplane with both engines still inoperative, and maintain straight flight with an angle of bank of not more than 5 degrees. V_{MCL-2} must be established with [the same conditions as V_{MCL} , except that]:

- The aeroplane trimmed for approach with one critical engine inoperative

- The thrust on the operating engine(s) necessary to maintain an approach path angle of 3 degrees when one critical engine is inoperative
- The thrust on the operating engine(s) rapidly changed, immediately after the second critical engine is made inoperative, from the [previous] thrust to:
 - the minimum thrust [and then to]
 - the go-around thrust setting

(h) In demonstrations of V_{MCL} and V_{MCL-2} , ... lateral control must be sufficient to roll the aeroplane from an initial condition of steady straight flight, through an angle of 20 degrees in the direction necessary to initiate a turn away from the inoperative engine(s) in not more than 5 seconds.”

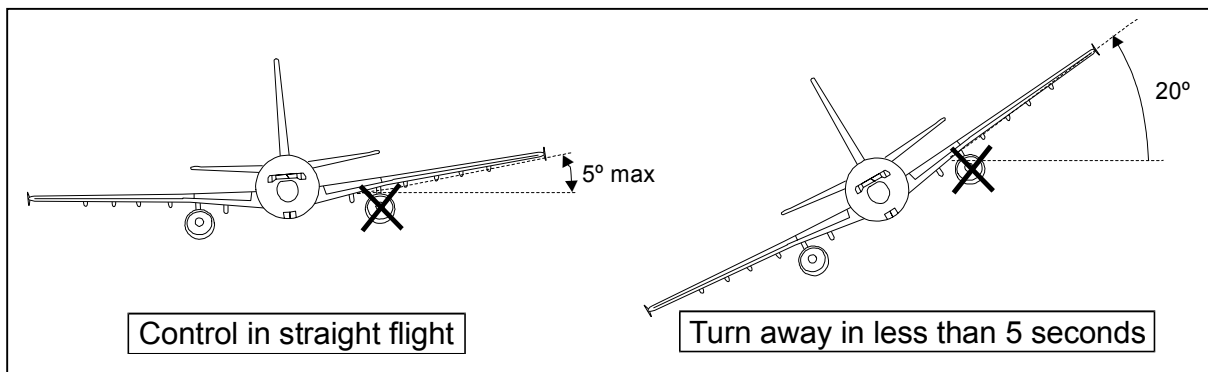

Figure B3: V_{MCL} and V_{MCL-2}

1.3.4. Minimum Unstick Speed: V_{MU}

JAR 25.107 Subpart B

FAR 25.107 Subpart B

“JAR/FAR 25.107 Take-off speeds

(d) V_{MU} is the calibrated airspeed at and above which the aeroplane can safely lift off the ground, and continue the take-off...”

During the flight test demonstration, at a low speed (80 - 100 kt), the pilot pulls the control stick to the limit of the aerodynamic efficiency of the control surfaces. The aircraft accomplishes a slow rotation to an angle of attack at which the maximum lift coefficient is reached, or, **for geometrically-limited aircraft**, until the tail strikes the runway (the tail is protected by a dragging device). Afterwards, the pitch is maintained until lift-off (Figure B4).

Two minimum unstick speeds must be determined and validated by flight tests:

- with all engines operatives : $V_{MU (N)}$
- with one engine inoperative : $V_{MU (N-1)}$

In the one-engine inoperative case, $V_{MU (N-1)}$ must ensure a safe lateral control to prevent the engine from striking the ground.

It appears that :

$$V_{MU (N)} \leq V_{MU (N-1)}$$

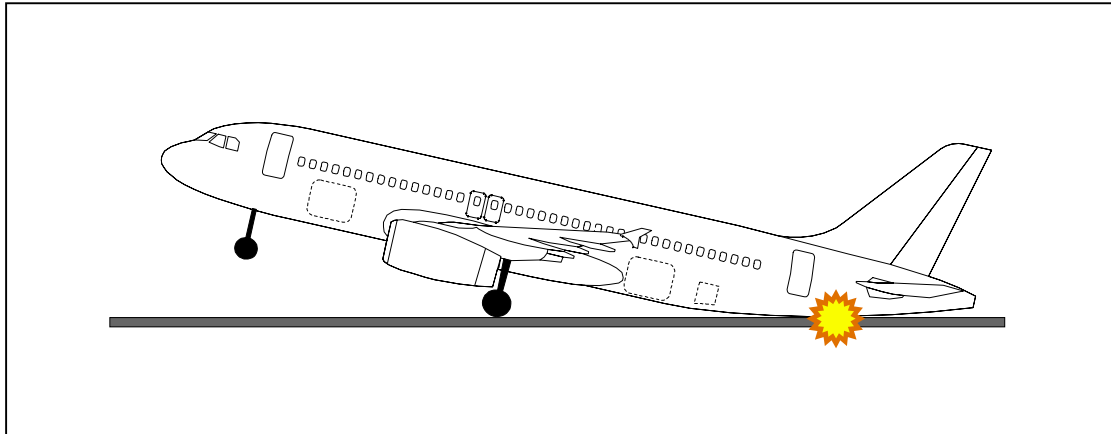
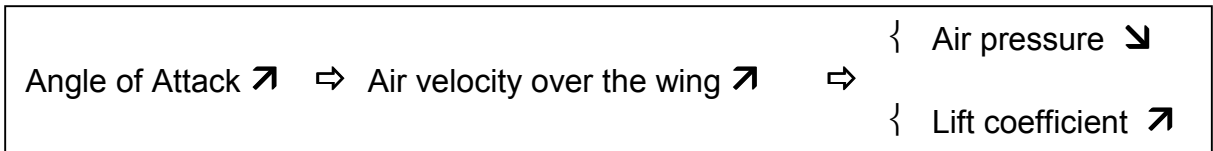

Figure B4: V_{MU} Demonstration (Geometrically-limited Aircraft)

1.3.5. Stall Speed

Air velocity over the wing increases with the angle of attack, so that air pressure decreases and the lift coefficient increases.



Therefore, the lift coefficient increases with the angle of attack. Flying at a constant level, this lift coefficient increase implies a decrease of the required speed. Indeed, the lift has to balance the aircraft weight, which can be considered as constant at a given time.

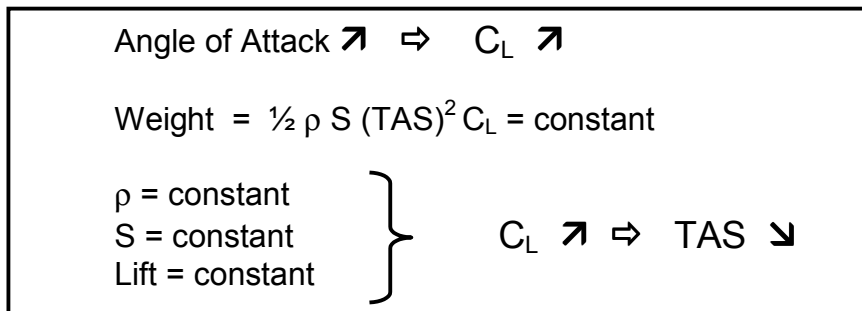

The speed cannot decrease beyond a minimum value. Above a certain angle of attack, the airflow starts to separate from the airfoil (Figure B5).

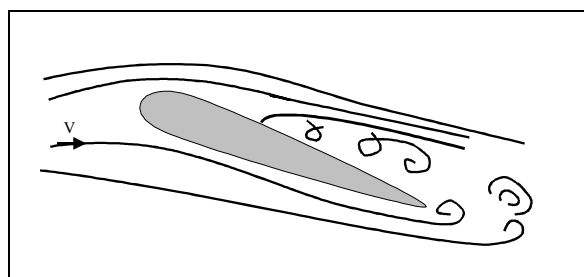

Figure B5: Airflow Separation

Figure B6 shows that the lift coefficient increases up to a maximum lift coefficient (C_{Lmax}), and suddenly decreases when the angle of attack is increased above a certain value.

This phenomenon is called a **stall** and two speeds can be identified :

- V_{S1g} , which corresponds to the maximum lift coefficient (i.e. just before the lift starts decreasing). At that moment, the load factor is still equal to one (JAR 25 reference stall speed).
- V_S , which corresponds to the conventional stall (i.e. when the lift suddenly collapses). At that moment, the load factor is always less than one (FAR 25 reference stall speed).

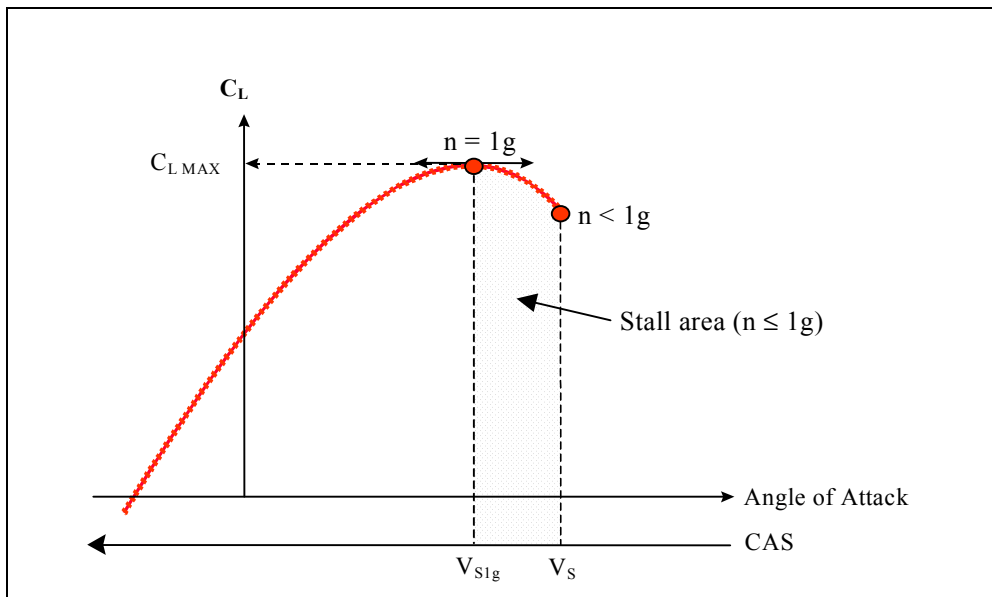

Figure B6: C_L versus Angle of Attack

JAR 25.103 Subpart B

“JAR 25.103 Stall speed

(a) The reference stall speed V_{SR} is a calibrated airspeed defined by the applicant. V_{SR} may not be less than a 1-g stall speed. V_{SR} is expressed as:

$$V_{SR} \geq \frac{V_{CLMAX}}{\sqrt{n_{zw}}}$$

Where:

V_{CLMAX} = [speed of maximum lift coefficient, i.e. V_{S1g}]
 n_{zw} = Load factor normal to the flight path at V_{CLMAX} ”

Change 15 of JAR 25 (October 2000) introduced this notion of **reference stall speed V_{SR} , which is the same as V_{S1g}** . In the previous version of JAR 25, a direct relationship between V_S and V_{S1g} was provided, in order to ensure the continuity between aircraft models certified at V_S , and aircraft models certified at V_{S1g} .

For JAR, this rapport between V_S and V_{S1g} is:

$$V_S = 0.94 \times V_{S1g}$$

As an example (refer to the “Takeoff” chapter):

- For aircraft models certified at V_S (A300/A310), $V_{2min} = 1.2 V_S$
- For aircraft models certified at V_{S1g} (Fly-By-Wire aircraft), $V_{2min} = 1.13 V_{S1g}$

IMPORTANT: In Airbus operational documentation, as well as in this brochure, V_{SR} is referred to as V_{S1g} .

FAR 25.103 Subpart B

“FAR 25.103 Stalling speed

(a) V_S is the calibrated stalling speed, or the minimum steady flight speed, in knots, at which the airplane is controllable, with Zero thrust at the stalling speed, or [...] with engines idling”.

FAR 25 doesn't make any reference to the 1-g stall speed requirement. Nevertheless, Airbus fly-by-wire aircraft have been approved by the FAA, under special conditions and similarly to JAA approval, with V_{S1g} as the reference stall speed.

2. MAXIMUM STRUCTURAL WEIGHTS

JAR 25.25 Subpart B
JAR 25.473 Subpart C
JAR-OPS 1.607 Subpart J

FAR 25.25 Subpart B
FAR 25.473 Subpart C
AC 120-27C

2.1. Aircraft Weight Definitions

- **Manufacturer's Empty Weight (MEW)** : The weight of the structure, power plant, furnishings, systems and other items of equipment that are considered an integral part of the aircraft. It is essentially a “dry” weight, including only those fluids contained in closed systems (e.g. hydraulic fluid).
- **Operational Empty Weight (OEW)** : The manufacturer's weight empty plus the operator's items, i.e. the flight and cabin crew and their baggage, unusable fuel, engine oil, emergency equipment, toilet chemicals and fluids, galley structure, catering equipment, seats, documents, etc...
- **Dry Operating Weight (DOW)** : The total weight of an aircraft ready for a specific type of operation excluding all usable fuel and traffic load. Operational Empty Weight plus items specific to the type of flight, i.e. catering, newspapers, pantry equipment, etc...

- **Zero Fuel Weight (ZFW)** : The weight obtained by addition of the total traffic load (payload including cargo loads, passengers and passenger’s bags) and the dry operating weight.
- **Landing Weight (LW)** : The weight at landing at the destination airport. It is equal to the Zero Fuel Weight plus the fuel reserves.
- **Takeoff Weight (TOW)**: The weight at takeoff at the departure airport. It is equal to the landing weight at destination plus the trip fuel (fuel needed for the trip), or to the zero fuel weight plus the takeoff fuel (fuel needed at the brake release point including reserves).

$\text{TOW} = \text{DOW} + \text{traffic load} + \text{fuel reserves} + \text{trip fuel}$ $\text{LW} = \text{DOW} + \text{traffic load} + \text{fuel reserves}$ $\text{ZFW} = \text{DOW} + \text{traffic load}$

Figure B7 shows the different aircraft’s weights, as defined in the regulations:

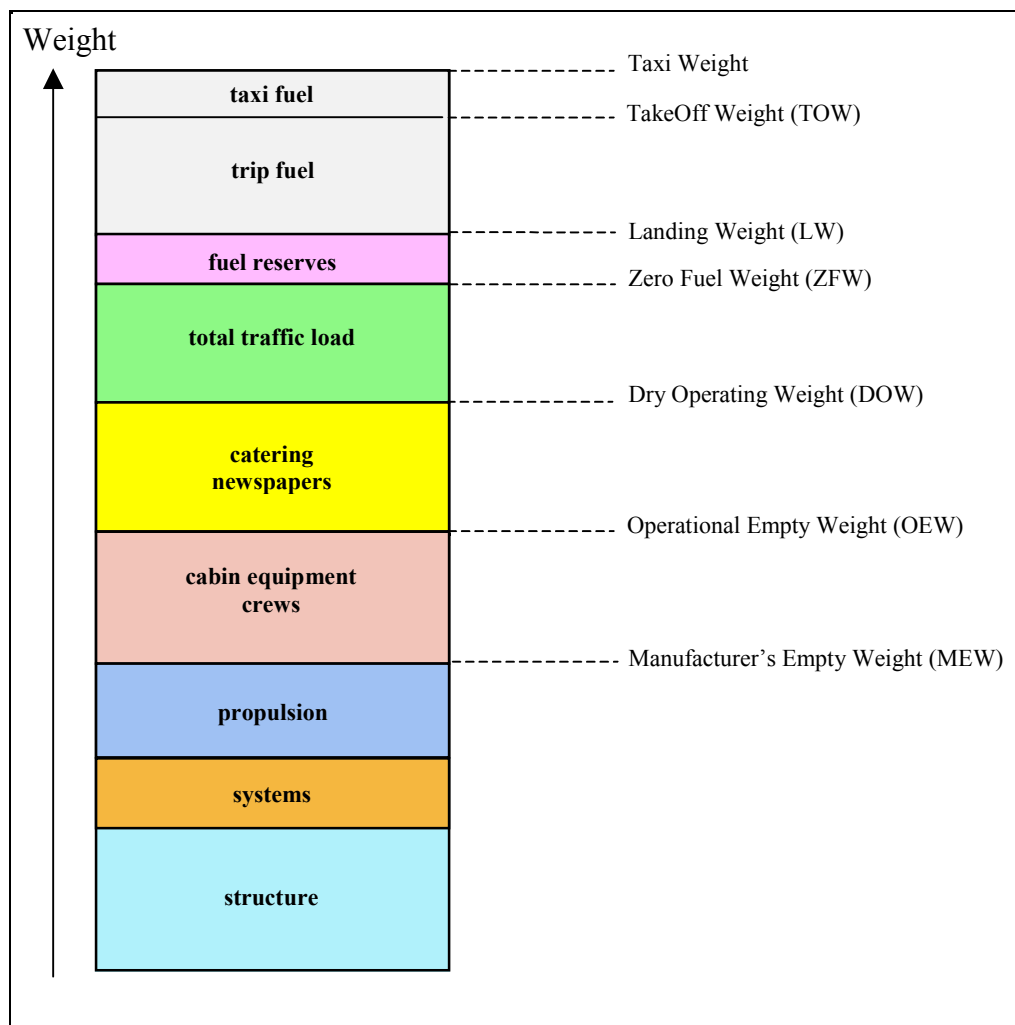

Figure B7: Aircraft Weights

2.2. Maximum Structural Takeoff Weight (MTOW)

The takeoff weight (TOW) must never exceed a Maximum structural TOW (MTOW) which is determined in accordance with in flight structure resistance criteria, resistance of landing gear and structure criteria during a landing impact with a vertical speed equal to **-1.83 m/s** (-360 feet/min).

2.3. Maximum Structural Landing Weight (MLW)

The landing weight (LW) is limited, assuming a landing impact with a vertical speed equal to **-3.05 m/s** (-600 feet/min). The limit is the maximum structural landing weight (MLW). The landing weight must comply with the relation:

$$\begin{aligned} \text{actual LW} &= \text{TOW} - \text{Trip Fuel} \leq \text{MLW} \\ \text{or} \\ \text{actual TOW} &\leq \text{MLW} + \text{Trip Fuel} \end{aligned}$$

2.4. Maximum Structural Zero Fuel Weight (MZFW)

Bending moments, which apply at the wing root, are maximum when the quantity of fuel in the wings is minimum (see Figure B8). During flight, the quantity of fuel located in the wings, m_{WF} , decreases. As a consequence, it is necessary to limit the weight when there is no fuel in the tanks. This limit value is called Maximum Zero Fuel Weight (MZFW).

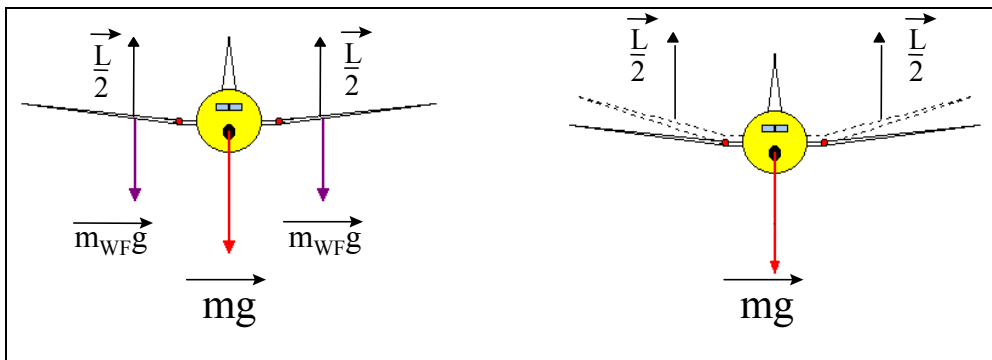

Figure B8: wing bending relief due to fuel weight

Therefore, the limitation is defined by:

$$\text{actual ZFW} \leq \text{MZFW}$$

The takeoff fuel is the sum of the trip fuel and the fuel reserves. Consequently:

$$\text{actual TOW} \leq \text{MZFW} + \text{Takeoff Fuel}$$

2.5. Maximum Structural Taxi Weight (MTW)

The Maximum Taxi Weight (MTW) is limited by the stresses on shock absorbers and potential bending of landing gear during turns on the ground.

Nevertheless, the MTW is generally not a limiting factor and it is defined from the MTOW, so that:

$$\text{MTW} - \text{Taxi Fuel} > \text{MTOW}$$

3. MINIMUM STRUCTURAL WEIGHT

JAR 25.25 Subpart B

FAR 25.25 Subpart B

The minimum weight is the lowest weight selected by the applicant at which compliance with each structural loading condition and each applicable flight requirement of JAR/FAR Part 25 is shown.

Usually, the gusts and turbulence loads are among the criteria considered to determine that minimum structural weight.

4. ENVIRONMENTAL ENVELOPE

JAR 25.1527 Subpart G

FAR 25.1527 Subpart G

“JAR/FAR 25.1527

The extremes of the ambient air temperature and operating altitude for which operation is allowed, as limited by flight, structural, powerplant, functional, or equipment characteristics, must be established.”

The result of this determination is the so-called environmental envelope, which features the pressure altitude and temperature limits. Inside this envelope, the aircraft's performance has been established and the aircraft systems have met certification requirements.

The following Figure (B9) is an example of an A320 environmental envelope, published in the Flight Crew Operating Manual (FCOM).

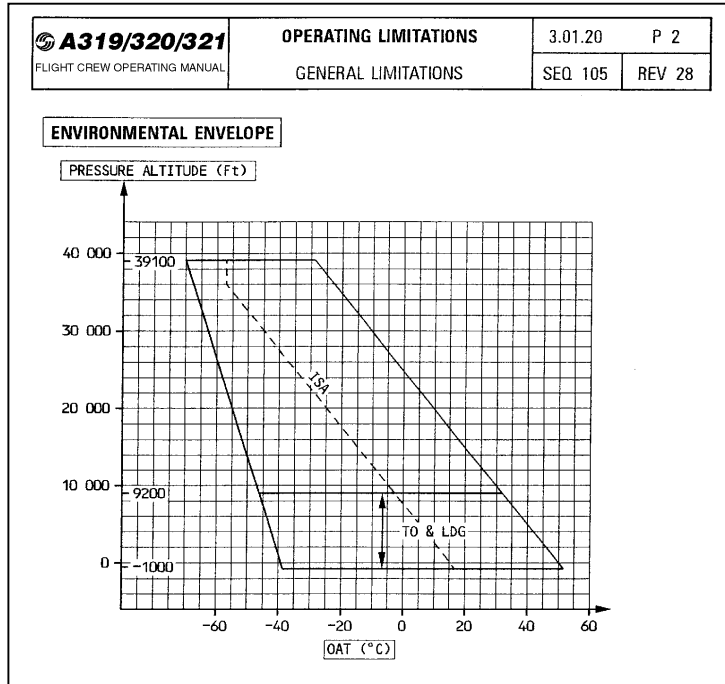

Figure B9: A320 Environmental Envelope

5. ENGINE LIMITATIONS

5.1. Thrust Setting and EGT Limitations

JAR 25.1521 Subpart G

FAR 25.1521 Subpart G

The main cause of engine limitations is due to the Exhaust Gas Temperature (EGT) limit (Figure B10).

A320 <small>FLIGHT CREW OPERATING MANUAL</small>	OPERATING LIMITATIONS		3.01.40	P 7
	SYSTEMS		REV 17	SEQ 020

POWER PLANT

1 – THRUST SETTING / EGT LIMITS :

OPERATING CONDITION	TIME LIMIT	EGT LIMIT	NOTE
TO and GA	5 mn	890° C	Only in case of engine failure
	10 mn		
MCT	Unlimited	855° C	
CL	Unlimited	855° C	
STARTING		725° C	

FM

Figure B10: Engine Limitations

- The **TakeOff (TOGA)** thrust represents the maximum thrust available for takeoff. It is certified for a maximum time of **10 minutes**, in case of **engine failure** at takeoff, or **5 minutes** with **all engines** operative.
- The **Go Around (TOGA)** thrust is the maximum thrust available for go-around. The time limits are the same as for takeoff.
- The **Maximum Continuous Thrust (MCT)** is the maximum thrust that can be used unlimitedly in flight. It must be selected in case of engine failure, when TOGA thrust is no longer allowed due to time limitation.
- The **Climb (CL)** thrust represents the maximum thrust available during the climb phase to the cruise flight level. Note that the maximum climb thrust is greater than the maximum cruise thrust available during the cruise phase.

5.2. Takeoff Thrust Limitations

Figure B11 shows the influence of pressure altitude and outside air temperature on the maximum takeoff thrust, for a given engine type.

At a given pressure altitude, temperature has no influence on engine takeoff thrust, below the so-called **reference temperature (T_{ref})** or **flat rating temperature**. Above this reference temperature, engine thrust is limited by the Exhaust Gas Temperature (EGT). The consequence is that the available thrust decreases as the temperature increases.

On the other hand, at a given temperature, any increase in the pressure altitude leads to decreasing the available takeoff thrust.

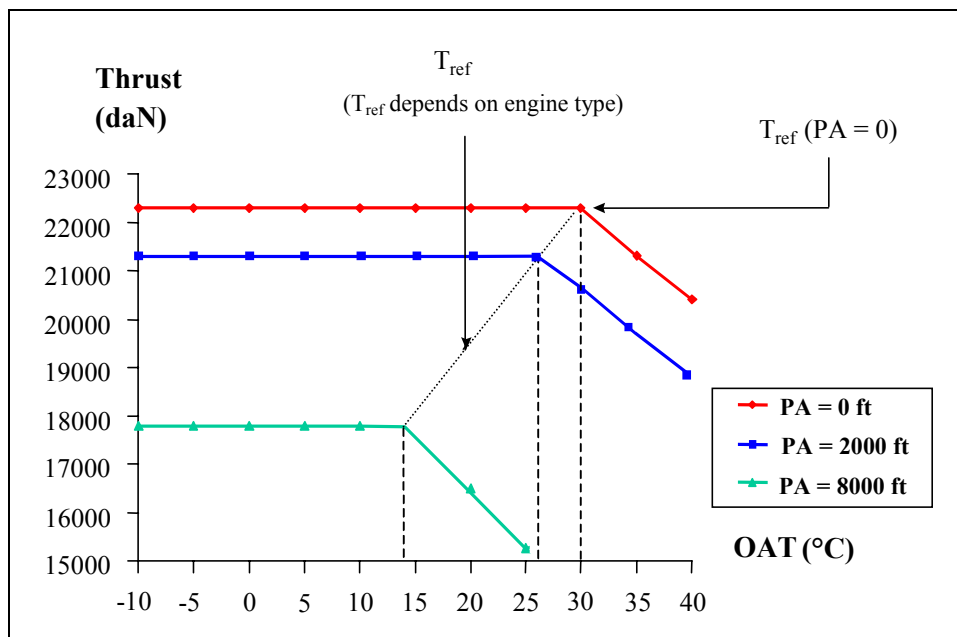

Figure B11: TOGA thrust versus OAT and PA for a given engine type

C. TAKEOFF

1. INTRODUCTION

The possibility of engine failure during takeoff should always be considered, and the crew must be provided with the appropriate means of deciding on the safest procedure in the event of such a failure.

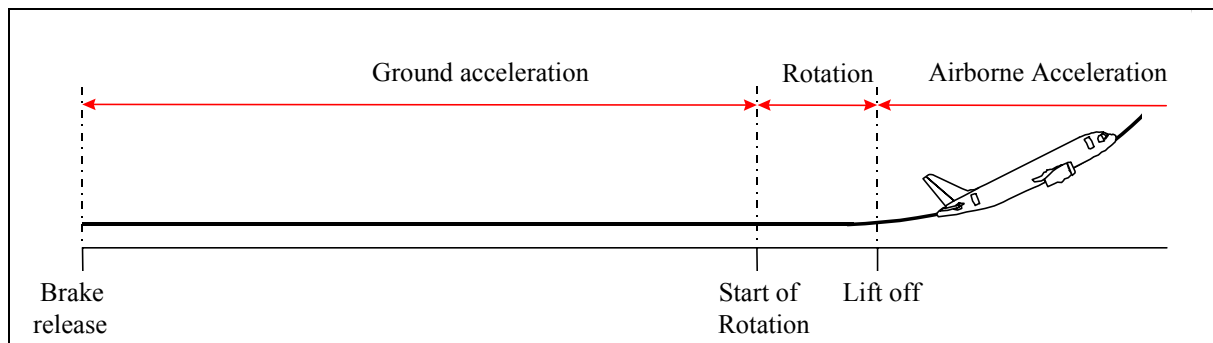

Figure C1: Takeoff Profile

During the takeoff phase, the pilot must achieve the sufficient speed and angle of attack conditions to balance the aircraft's lift and weight forces.

At the end of the ground acceleration phase, the pilot pulls the stick to start the **rotation**. During this phase, acceleration is maintained and the angle of attack is increased in order to achieve a higher lift. The ground reactions progressively decrease until **lift off**.

As mentioned above, the performance determination must take into account **the possibility of an engine failure** during the ground acceleration phase. For FAR/JAR certified aircraft, failure of the **most critical engine** must be considered.

JAR 1.1

FAR 1.1

“JAR/FAR 1.1 : 'Critical Engine' means the engine whose failure would most adversely affect the performance or handling qualities of an aircraft”, i.e. an outer engine on a four engine aircraft.

2. TAKEOFF SPEEDS

2.1. Operational Takeoff Speeds

2.1.1. Engine Failure Speed: V_{EF}

JAR 25.107 Subpart B

FAR 25.107 Subpart B

“JAR/FAR 25.107

(a)(1) V_{EF} is the calibrated airspeed at which the critical engine is assumed to fail. V_{EF} must be selected by the applicant, but may not be less than V_{MCG} .”

2.1.2. Decision Speed: V_1

JAR 25.107 Subpart B

FAR 25.107 Subpart B

V_1 is the maximum speed at which the crew can decide to reject the takeoff, and is ensured to stop the aircraft within the limits of the runway.

“JAR/FAR 25.107

(a)(2) V_1 , in terms of calibrated airspeed, is selected by the applicant; however, V_1 may not be less than V_{EF} plus the speed gained with the critical engine inoperative during the time interval between the instant at which the critical engine is failed, and the instant at which the pilot recognises and reacts to the engine failure, as indicated by the pilot's initiation of the first action (e.g. applying brakes, reducing thrust, deploying speed brakes) to stop the aeroplane during accelerate-stop tests.”

V_1 can be selected by the applicant, assuming that an engine failure has occurred at V_{EF} . The time which is considered between the critical engine failure at V_{EF} , and the pilot recognition at V_1 , is 1 second. Thus:

$$V_{MCG} \leq V_{EF} \leq V_1$$

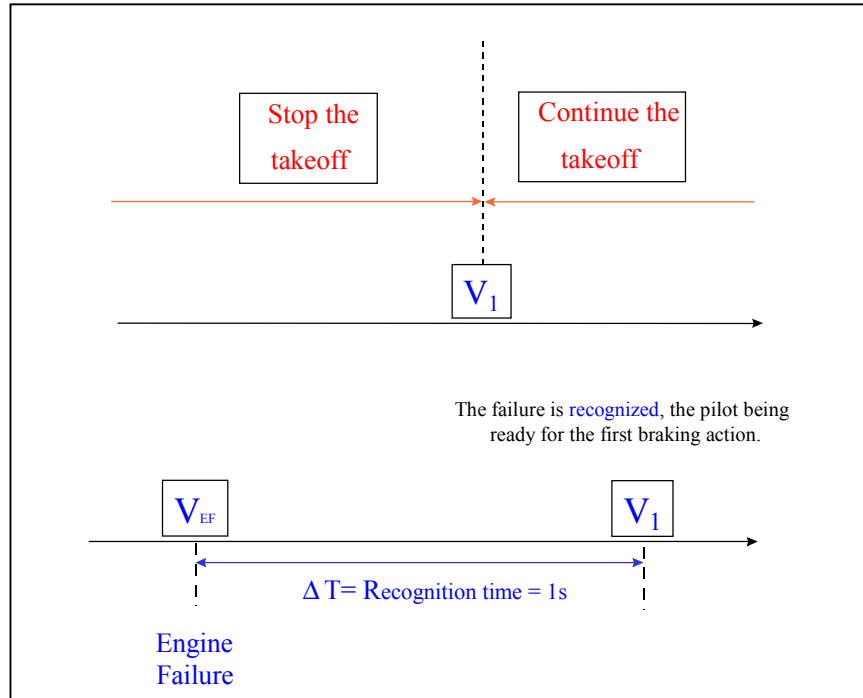

Figure C2: Decision Speed

This speed is entered by the crew in the Multipurpose Control and Display Unit (MCDU) during flight preparation, and it is represented by a “1” on the speed scale of the Primary Flight Display (PFD) during takeoff acceleration (See Figure C3).

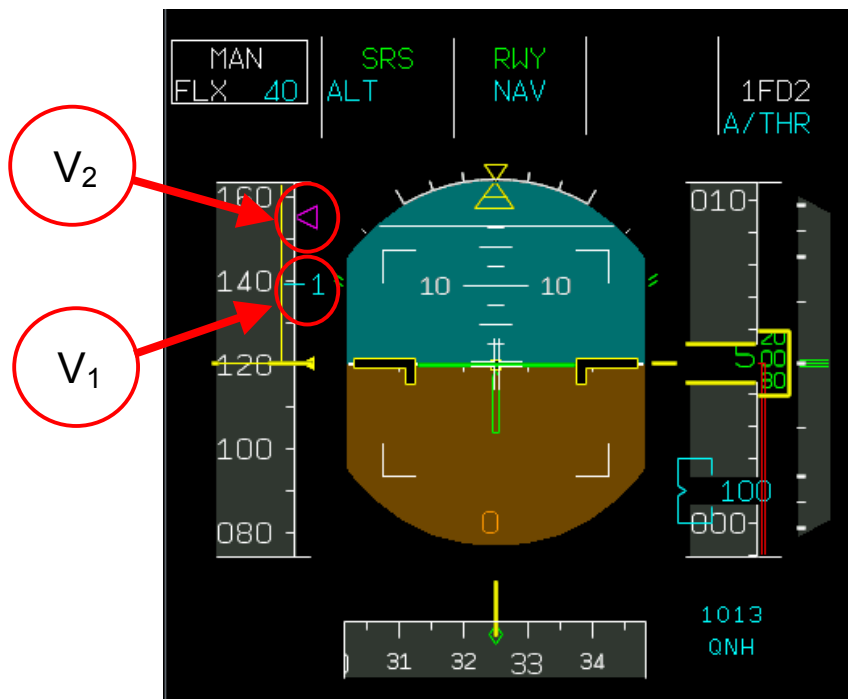

Figure C3: Information provided by the PFD

2.1.3. Rotation Speed: V_R

JAR 25.107 Subpart B

FAR 25.107 Subpart B

V_R is the speed at which the pilot initiates the rotation, at the appropriate rate of about 3° per second.

“JAR/FAR 25.107

(e) V_R , in terms of calibrated air speed, [...] may not be less than:

- V_1 ,
- 105% of V_{MCA}
- The speed that allows reaching V_2 before reaching a height of 35 ft above the take-off surface, or
- A speed that, if the aeroplane is rotated at its maximum practicable rate, will result in a [satisfactory] V_{LOF} ”

V_R is entered in the MCDU by the crew during the flight preparation.

$$V_R \geq 1.05 V_{MCA}$$

2.1.4. Lift-off Speed: V_{LOF}

JAR 25.107 Subpart B

FAR 25.107 Subpart B

FAR AC 25-7A

“JAR/FAR 25.107

(f) V_{LOF} is the calibrated airspeed at which the aeroplane first becomes airborne.”

Therefore, it is the speed at which the lift overcomes the weight.

“JAR/FAR 25.107

(e) [...] V_{LOF} [must] not [be] less than 110% of V_{MU} in the all-engines-operating condition and not less than 105% of V_{MU} determined at the thrust-to-weight ratio corresponding to the one-engine-inoperative condition.”

The regulations consider the particular case of aircraft which are geometrically-limited, or limited by the elevator efficiency at high angle of attack.

An aircraft is said to be geometrically-limited, when, at its maximum angle of attack (the tail of the aircraft hits the ground while the main landing gear is still on ground), the maximum lift coefficient is not reached. In these conditions, the margins can be reduced, as follows:

“JAR 25.107 (only valid for JAR)

(e) [...] in the particular case that lift-off is limited by the geometry of the aeroplane, or by elevator power, the above margins may be reduced to 108% in the all-engines-operating case and 104% in the one-engine-inoperative condition.”

“AC 25-7A (only valid for FAR)

For airplanes that are geometry limited, the 110 percent of V_{MU} required by § 25.107(e) may be reduced to an operationally acceptable value of 108 percent on the basis that equivalent airworthiness is provided for the geometry-limited airplane.”

Airbus aircraft, as most commercial airplanes, are generally geometrically-limited. For those aircraft, certification rules differ between JAR and FAR, as summarized in Table C1:

	JAR	FAR
Geometric Limitation	$V_{LOF} \geq 1.04 V_{MU(N-1)}$	$V_{LOF} \geq 1.05 V_{MU(N-1)}$
	$V_{LOF} \geq 1.08 V_{MU(N)}$	$V_{LOF} \geq 1.08 V_{MU(N)}$
Aerodynamic Limitation	$V_{LOF} \geq 1.05 V_{MU(N-1)}$	
	$V_{LOF} \geq 1.10 V_{MU(N)}$	

Table C1: V_{LOF} Limitation

2.1.5. Takeoff Climb Speed: V_2

JAR 25.107 Subpart B

FAR 25.107 Subpart B

V_2 is the minimum climb speed that must be reached at a height of 35 feet above the runway surface, in case of an engine failure.

“JAR/FAR 25.107

(b) V_{2min} , in terms of calibrated airspeed, may not be less than:

- $1.13 V_{SR}^1$ (JAR) or $1.2 V_S$ (FAR) for turbo-jet powered aeroplanes [...]
- 1.10 times V_{MCA}

(c) V_2 , in terms of calibrated airspeed, must be selected by the applicant to provide at least the gradient of climb required by JAR 25.121(b) but may not be less than:

- V_{2min} ; and
- V_R plus the speed increment attained before reaching a height of 35 ft above the take-off surface.”

This speed must be entered by the crew during flight preparation, and is represented by a magenta triangle on the speed scale (see Figure C3).

$$V_2 \geq 1.1 V_{MCA}$$

$$V_2 \geq 1.13 V_{s1g} \text{ (Airbus Fly-By-Wire aircraft)}^2$$

$$V_2 \geq 1.2 V_S \quad \text{(Other Airbus types)}$$

¹ V_{SR} is the 1-g stall speed V_{S1g} (refer to the “Aircraft limitations” chapter).

² Airbus FBW aircraft are FAA approved, under special condition, with the 1-g reference stall speed.

2.2. Takeoff Speed Limits

2.2.1. Maximum Brake Energy Speed: V_{MBE}

When the takeoff is aborted, brakes must absorb and dissipate the heat corresponding to the aircraft's kinetic energy at the decision point ($1/2 \cdot TOW \cdot V_1^2$).

JAR 25.109 Subpart B

FAR 25.109 Subpart B

“JAR/FAR 25.109

(h) A flight test demonstration of the maximum brake kinetic energy accelerate-stop distance must be conducted with no more than 10% of the allowable brake wear range remaining on each of the aeroplane wheel brakes.”

Brakes have a maximum absorption capacity, known as maximum brake energy. For certification purposes, this absorption capacity must be demonstrated with worn brakes (post-amendment 42 only). As a result, the speed at which a full stop can be achieved for a given takeoff weight is limited to a maximum value (V_{MBE}). Thus, for a given takeoff weight:

$$V_1 \leq V_{MBE}$$

2.2.2. Maximum Tire Speed: V_{TIRE}

The tire manufacturer specifies the maximum ground speed that can be reached, in order to limit the centrifugal forces and the heat elevation that may damage the tire structure. Thus:

$$V_{LOF} \leq V_{TIRE}$$

For almost all Airbus aircraft models, V_{TIRE} is equal to 195 knots (Ground Speed).

2.3. Speed Summary

The following Figure illustrates the relationships and the regulatory margins between the certified speeds (V_{S1G} , V_{MCG} , V_{MCA} , V_{MU} , V_{MBE} , V_{TIRE}), and the takeoff operating speeds (V_1 , V_R , V_{LOF} , V_2).

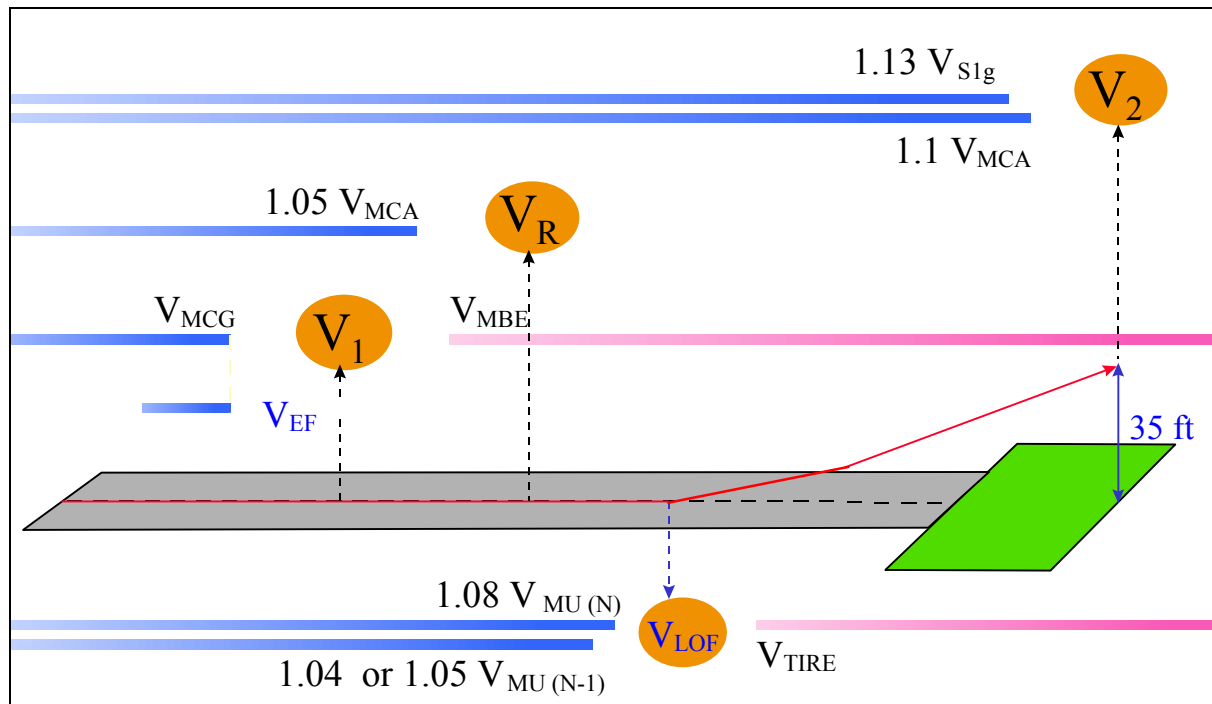

Figure C4: Takeoff Speed Summary and Limitations related to V_1 , V_R , V_{LOF} and V_2

3. RUNWAY LIMITATIONS

3.1. Takeoff Distances

3.1.1. Regulatory Background

The different Airbus types have been certified at different times and comply with different certification rules. A major change occurred when the FAA published an amendment to FAR Part 25, known as “Amendment 25-42”. This amendment, which became effective on March 1, 1978, revised the takeoff performance standards and made them more restrictive.

To summarize, **Amendment 25-42** required the accelerate-stop distance to include **two seconds of continued acceleration** beyond V_1 speed, before the pilot takes any action to stop the airplane. It also introduced the notion of **Accelerate-Stop Distance all engines**. This revision resulted in longer accelerate-stop distances for airplanes whose application for a type certificate was made after amendment 25-42 became effective. The **A320** was the first airplane to be certified under this rule, as no retroactivity was required. It was also the last one.

Although the airplane types were originally certified at different times, thus allowing the use of different amendments, both groups of airplanes were continuing in production and competing for sales and for use over some common routes. Airplanes whose designs were type-certified to the standards introduced by Amendment 25-42 were penalized in terms of payload, even though the airplane’s takeoff performance

might be better from a safety perspective, than the design of a competing airplane that was not required to meet the latest standards.

This disparity in airworthiness standards has created an unfair international trade situation, affecting the competitiveness of a later design of the A320. At the June 1990 annual meeting, the FAA and JAA agreed to jointly review the current takeoff performance standards to reduce the above-discussed inequities, without adversely affecting safety. In March 1992, the JAA Notice for Proposed Amendment (NPA) 25B,D,G-244: "Accelerate-Stop Distances and Related Performance Matters" was issued, followed by the FAA Notice of Proposed Rule Making (NPRM) 93-8 on July 1993. The rule changes proposed in the NPA and in the NPRM were essentially the same, and are better known as Post-Amendment 42.

To summarize, NPA 244 and NPRM 93-08 (**post-amendment 42**) proposed the following rule changes:

- 1 – Replace the two seconds of continued acceleration beyond V_1 , with a distance margin equal to **two seconds at V_1 speed**
- 2 – Require that the **runway surface condition (dry or wet)** be taken into account, when determining the runway length that must be available for takeoff.
- 3 – Require that the capability of the brakes to absorb energy and stop the airplane during landings and rejected takeoffs be based on **brakes that are worn to their overhaul limit**.

After industry feedback, NPA 244 was incorporated into JAR 25 on October 2000 (change 15), whereas NPRM 93-08 was incorporated into FAR 25 on February 1998 (amendment 25-92). The definitions provided in the following sections refer to the latest airworthiness standards (i.e. post amendment 42).

As a reminder, the certification status of the Airbus models is the following:

- **Pre-amendment 42** : **A300, A300-600, A310**
- **Amendment 25-42** : **A320¹**
- **Post-amendment 42** : **A318, A319, A320¹, A321, A330, A340**

3.1.2. Takeoff Distance (TOD)

JAR 25.113 Subpart B

FAR 25.113 Subpart B

For given operational conditions (temperature, pressure altitude, weight, etc.):

a) The takeoff distance on a **dry** runway is **the greater** of the following values:

- **$TOD_{N-1 \text{ dry}}$** = Distance covered from the brake release to a point at which the aircraft is at 35 feet above the takeoff surface, assuming the failure of the critical engine at V_{EF} and recognized at V_1 ,
- **$1.15 \text{ } TOD_{N \text{ dry}}$** = 115% of the distance covered from brake release to a point at which the aircraft is at 35 feet above the takeoff surface, assuming all engines operating.

¹ Some A320s are certified with amendment 25-42, others with post-amendment 42.

$$\text{TOD}_{\text{dry}} = \max \{ \text{TOD}_{\text{N-1 dry}}, 1.15 \text{TOD}_{\text{N dry}} \}$$

b) The takeoff distance on a **wet** runway is **the greater** of the following values:

- TOD_{dry} = Takeoff distance on a dry runway (see above),
- $\text{TOD}_{\text{N-1 wet}}$ = Distance covered from brake release to a point at which the aircraft is at 15 feet above the takeoff surface, ensuring the V_2 speed to be achieved before the airplane is 35 feet above the takeoff surface, assuming failure of the critical engine at V_{EF} and recognized at V_1 .

$$\text{TOD}_{\text{wet}} = \max \{ \text{TOD}_{\text{dry}}, \text{TOD}_{\text{N-1 wet}} \}$$

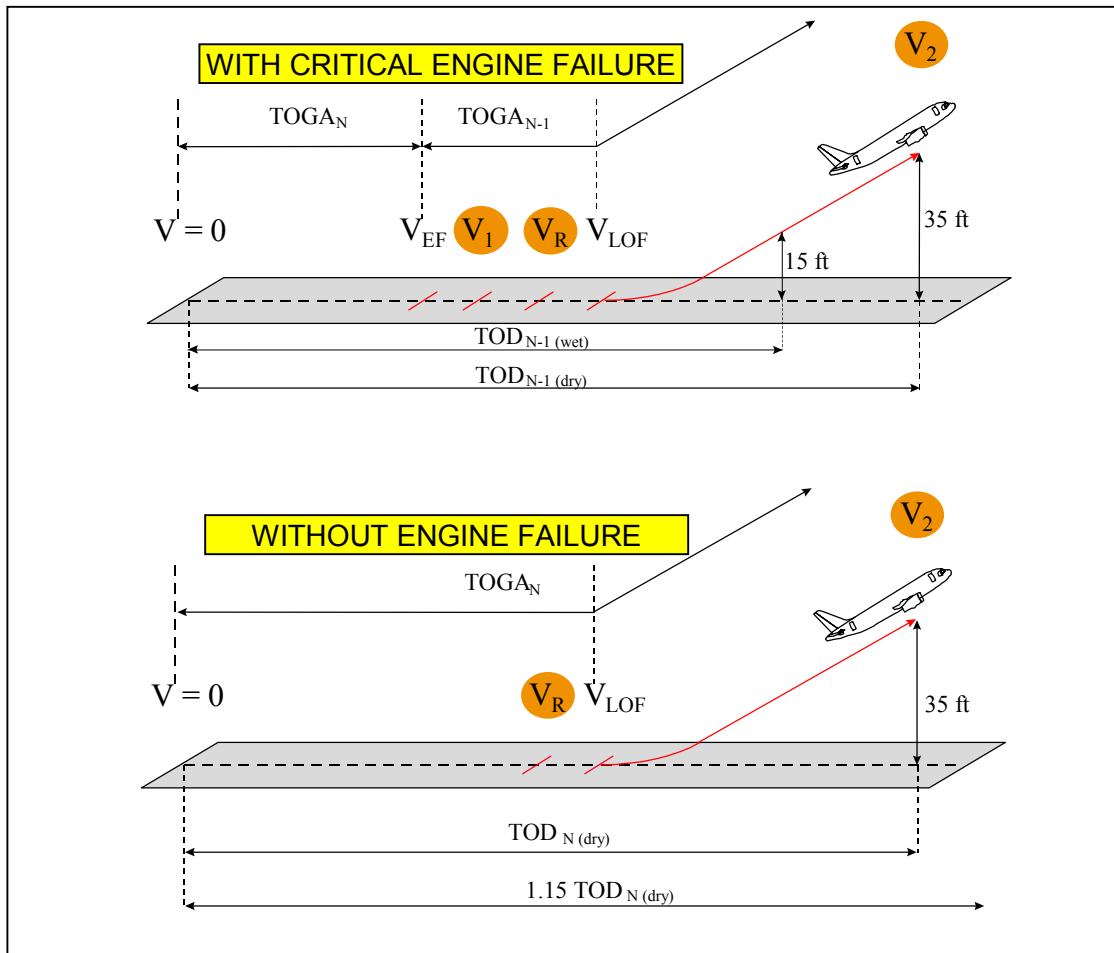

Figure C5: Takeoff Distance (TOD)

3.1.3. Takeoff Run (TOR)

JAR 25.113 Subpart B FAR 25.113 Subpart B

3.1.3.1. Runway with Clearway

a) The takeoff run on a **dry runway** is the **greater** of the following values (Figure C6):

- $TOR_{N-1 \text{ dry}}$ = Distance covered from brake release to a point equidistant between the point at which V_{LOF} is reached and the point at which the aircraft is 35 feet above the takeoff surface, assuming failure of the critical engine at V_{EF} and recognized at V_1 ,
- $1.15 TOR_{N \text{ dry}}$ = 115 % of the distance covered from brake release to a point equidistant between the point at which V_{LOF} is reached and the point at which the aircraft is 35 feet above the takeoff surface, assuming all engines operating.

$$TOR_{\text{dry}} = \max \text{ of } \{TOR_{N-1 \text{ dry}}, 1.15 TOR_{N \text{ dry}}\}$$

b) The takeoff run on a **wet runway** is the **greater** of the following values:

- $TOR_{N-1 \text{ wet}}$ = Distance covered from the brake release to a point at which the aircraft is at 15ft above the takeoff surface, ensuring the V_2 speed to be achieved before the airplane is 35 feet above the takeoff surface, assuming the failure of the critical engine at V_{EF} and recognized at V_1 . It is equal to $TOD_{N-1 \text{ wet}}$.
- $1.15 TOR_{N \text{ wet}}$ = 115 % of the distance covered from brake release to a point equidistant between the point at which V_{LOF} is reached and the point at which the aircraft is 35 feet above the takeoff surface, assuming all engines operating.

$$TOR_{\text{wet}} = \max \text{ of } \{TOR_{N-1 \text{ wet}}, 1.15 TOR_{N \text{ wet}}\}$$

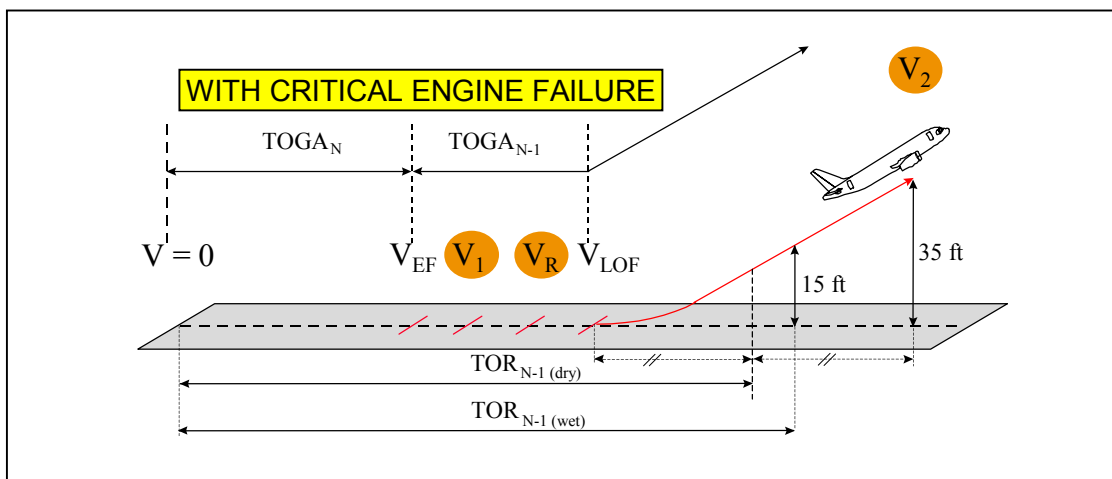

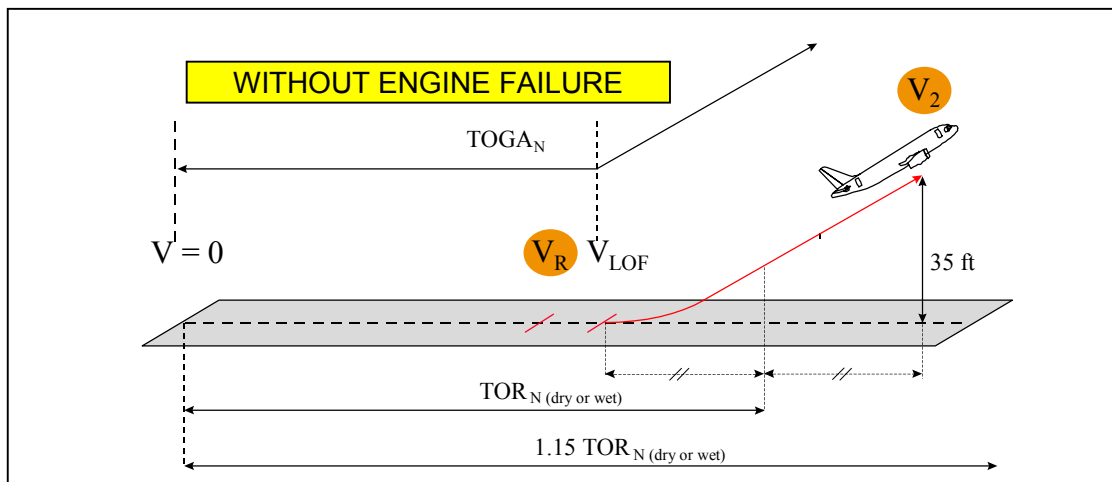

Figure C6: Takeoff Run (TOR) with a Clearway

3.1.3.2. Runway without Clearway

The **takeoff run** is equal to the **takeoff distance**, whatever the takeoff surface (dry or wet).

3.1.3.3. Clearway Influence on a Wet Runway

With a wet runway, the takeoff run with one engine-out is always equal to the takeoff distance with one engine-out (i.e. from brake release to 15 feet). Therefore, a **clearway does not give any performance benefit on a wet runway**, as the TOR is always more limiting (TORA less than TODA).

3.1.4. Accelerate-Stop Distance (ASD)

JAR 25.109 Subpart B

FAR 25.109 Subpart B

a) The accelerate-stop distance on a **dry runway** is the **greater** of the following values:

- **ASD_{N-1 dry}** = Sum of the distances necessary to:
 - Accelerate the airplane with all engines operating to V_{EF} ,
 - Accelerate from V_{EF} to V_1 ¹ assuming the critical engine fails at V_{EF} and the pilot takes the first action to reject the takeoff at V_1
 - Come to a full stop²³
 - Plus a distance equivalent to 2 seconds at constant⁴ V_1 speed

¹ Delay between V_{EF} and $V_1 = 1$ second

² ASD must be established with the "wheel brakes at the fully worn limit of their allowable wear range" [JAR/FAR 25.101]

³ ASD shall not be determined with reverse thrust on a dry runway

⁴ Pre-amendment 42 : no additional distance

Amendment 25-42 : 2 seconds of continuing acceleration after V_1

- $ASD_{N\ dry}$ = Sum of the distances necessary to:
 - Accelerate the airplane with all engines operating to V_1 , assuming the pilot takes the first action to reject the takeoff at V_1
 - With all engines still operating come to a full stop
 - Plus a distance equivalent to 2 seconds at constant V_1 speed

$$ASD_{dry} = \max \{ ASD_{N-1\ dry}, ASD_{N\ dry} \}$$

b) The accelerate-stop distance on a **wet runway** is **the greater** of the following values:

- ASD_{dry}
- $ASD_{N-1\ wet}$ = same definition as $ASD_{N-1\ dry}$ except the runway is wet¹
- $ASD_{N\ wet}$ = same definition as $ASD_{N\ dry}$ except the runway is wet

$$ASD_{wet} = \max \{ ASD_{dry}, ASD_{N-1\ wet}, ASD_{N\ wet} \}$$

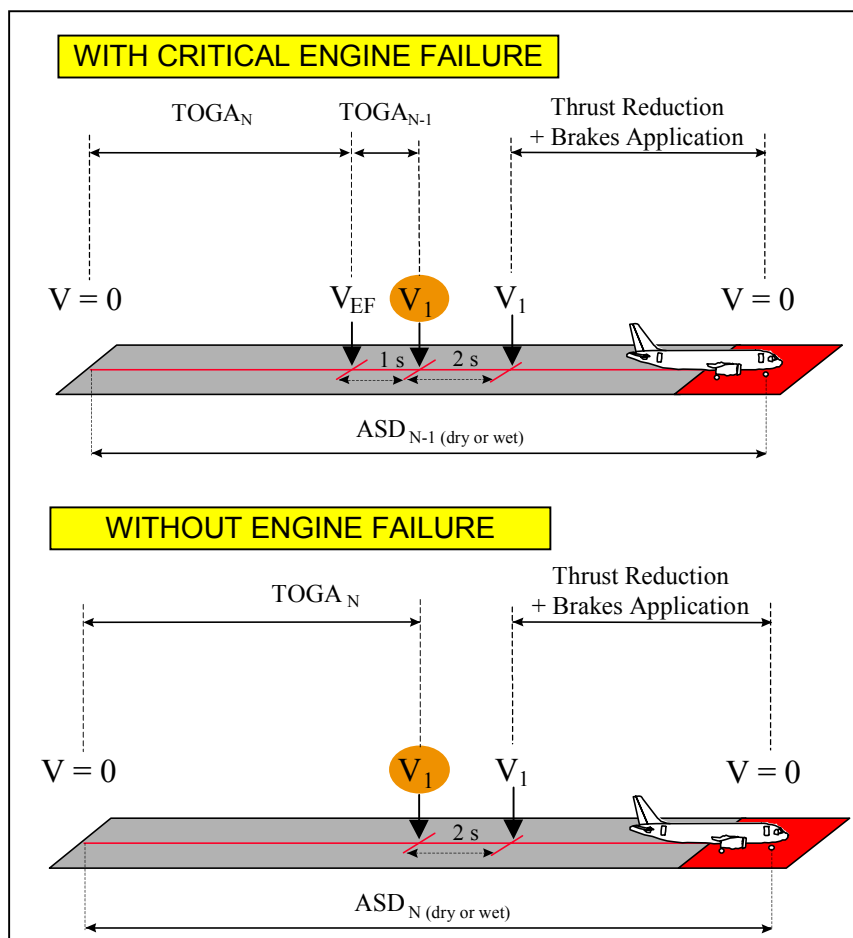

Figure C7: Accelerate Stop Distance (ASD)

¹ ASD determination on a wet runway may include the use of the reverse thrust provided it is safe and reliable [JAR/FAR 25-109 (e)(f)]

3.1.5. Influence of V_1 on Accelerate-Go/Stop Distances

For a given takeoff weight, any **increase in V_1** leads to a **reduction in both TOD_{N-1} and TOR_{N-1}** . The reason is that the all engine acceleration phase is longer with a higher V_1 speed, and, consequently, in case of an engine failure occurring at V_{EF} , the same V_2 speed can be achieved at 35 feet at a shorter distance.

On the other hand, **TOD_N and TOR_N are independent of V_1** as there is no engine failure, and thus no consequence on the acceleration phase and the necessary distance to reach 35 feet.

On the contrary, for a given takeoff weight, any **increase in V_1** leads to an **increase in both the ASD_{N-1} and ASD_N** . Indeed, with a higher V_1 speed, the acceleration segment from brake release to V_1 is longer, the deceleration segment from V_1 to the complete stop is longer, and the 2 second segment at constant V_1 speed is longer.

As a result, the following graph providing the takeoff/rejected takeoff distances as a function of V_1 can be plotted. This graph clearly shows that a minimum distance is achieved at a particular V_1 speed. This speed is called “balanced V_1 ”, and the corresponding distance is called “balanced field”.

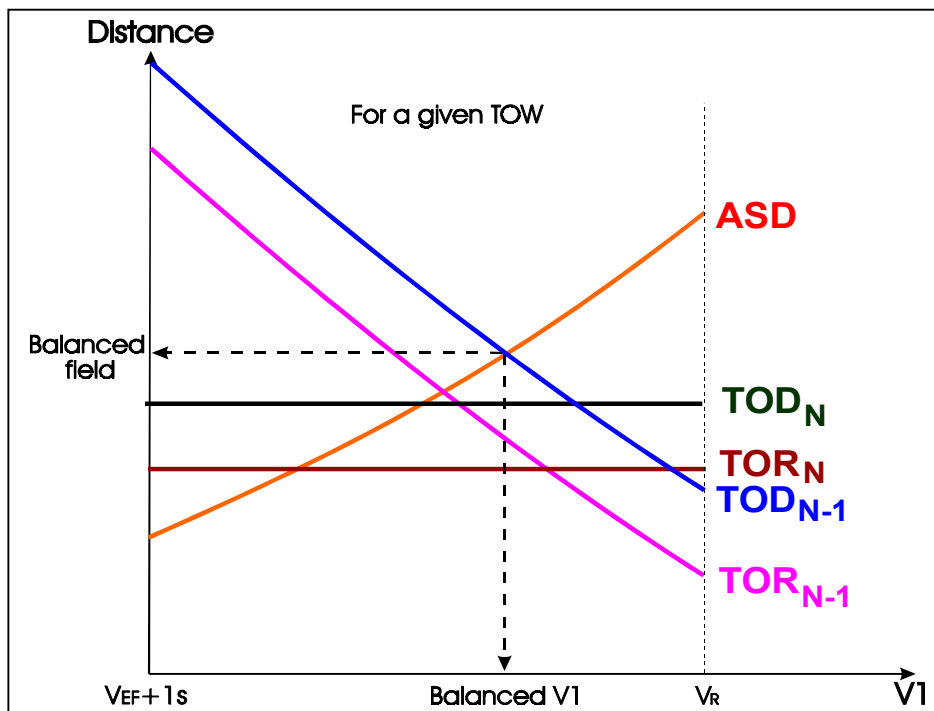

Figure C8: Influence of V_1 on Accelerate-go/stop Distances for a Given Weight

3.2. Available Takeoff Lengths

3.2.1. Takeoff Run Available (TORA)

JAR-OPS 1.480 Subpart F

“JAR-OPS 1.480

(a)(9) **TakeOff Run Available (TORA)**: The length of runway which is declared available by the appropriate authority and suitable for the ground run of an aeroplane taking off.”

TORA is either equal to the runway length, or to the distance from the runway entry point (intersecting taxiway) to the end of the runway (Figure C9).

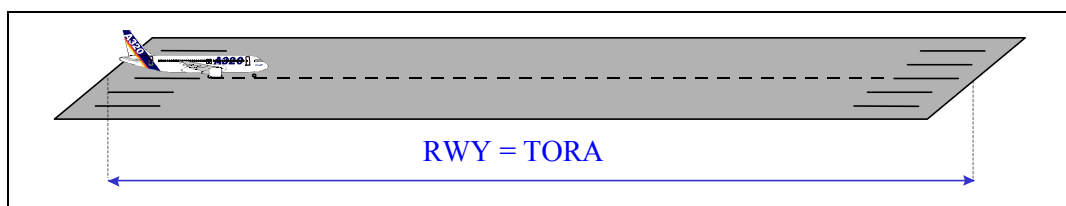

Figure C9: Definition of TORA

JAR-OPS 1.490 Subpart G

FAR 121.189 (c)(3) Subpart I

“JAR-OPS 1.490

(b)(3) The Takeoff run must not exceed the takeoff run available.”

$$\text{TOR} \leq \text{TORA}$$

3.2.2. Takeoff Distance Available (TODA)

JAR 1.1 General definitions

FAR 1.1 General definitions

The runway may be extended by an area called the **clearway**. The clearway is an area beyond the runway, which should have the following characteristics: It must:

- Be centrally located about the extended centerline of the runway, and under the control of the airport authorities.
- Be expressed in terms of a clearway plane, extending from the end of the runway with an upward slope not exceeding 1.25%.
- Have a minimum width not less than 152 m (500 feet) wide.
- Have no protruding objects or terrain. Threshold lights may protrude above the plane, if their height above the end of the runway is 0.66 m (26 in) or less, and if they are located on each side of the runway.

JAR-OPS 1.480 Subpart F

“JAR-OPS 1.480

(a)(7) **Takeoff Distance Available (TODA)**: The length of the takeoff run available plus the length of the clearway available.”

As shown in Figure C10, the **Takeoff Distance Available (TODA)** corresponds to the Takeoff Run Available (TORA) plus the clearway (CWY), if any.

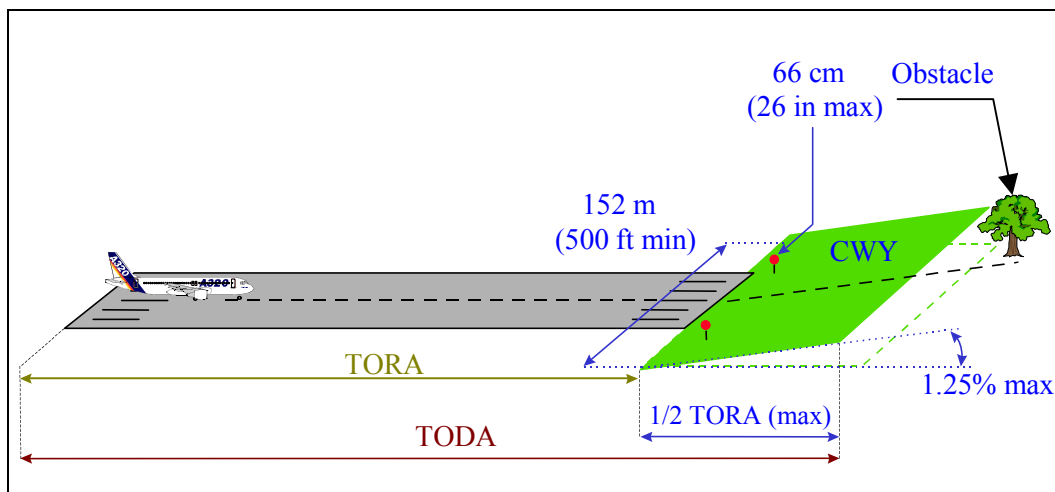

Figure C10: TODA Definition

JAR-OPS 1.490 Subpart G

FAR 121.189 (c)(2) Subpart I

“JAR-OPS 1.490

(b)(2) The Takeoff distance must not exceed the takeoff distance available, with a clearway distance not exceeding half of the takeoff run available.”

$$\text{TOD} \leq \text{TODA}$$

3.2.3. Accelerate-Stop Distance Available (ASDA)

JAR 1.1 General Definitions

FAR 1.1 General Definitions

The runway may be extended by an area called the **stopway**. The stopway is an area beyond the runway, which should have the following characteristics. It must be :

- At least as wide as the runway, and centered upon the extended centerline of the runway.
- Able to support the airplane during an abortive takeoff, without causing structural damage to the airplane.
- Designated by the airport authorities for use in decelerating the airplane during an abortive takeoff.

JAR-OPS 1.480 Subpart F

“JAR-OPS 1.480

(a)(1) **Accelerate-Stop Distance Available (ASDA)**: The length of the takeoff run available plus the length of the stopway, if such stopway is declared available by the appropriate Authority and is capable of bearing the mass of the aeroplane under the prevailing operating conditions.”

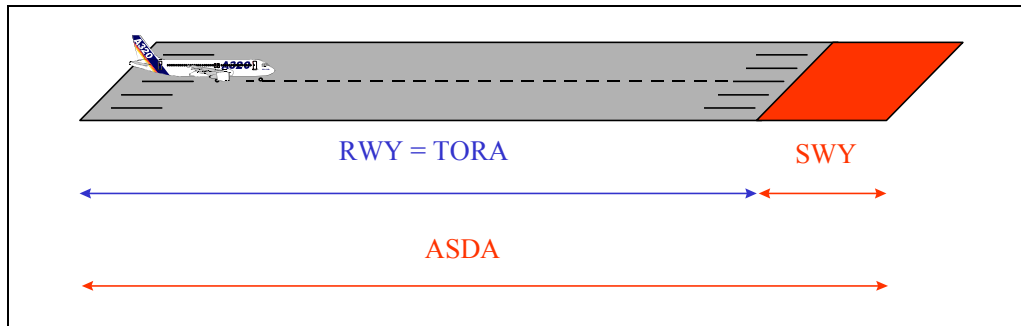

Figure C11: ASDA Definition

JAR-OPS 1.490 Subpart G

FAR 121.189 (c)(1) Subpart I

“JAR-OPS 1.490

(b)(1) The accelerate-stop distance must not exceed the accelerate-stop distance available.”

$$ASD \leq ASDA$$

3.2.4. Loss of Runway Length due to Alignment

Airplanes typically enter the takeoff runway from an intersecting taxiway. The airplane must be turned so that it is pointed down the runway in the direction for takeoff. FAA regulations do not explicitly require airplane operators to take into account the runway distance used to align the airplane on the runway for takeoff. On the contrary, JAA regulations require such a distance to be considered:

JAR-OPS 1.490 Subpart G
IEM OPS 1.490

“JAR-OPS 1.490

(c)(6) [...] an operator must take account of the loss, if any, of runway length due to alignment of the aeroplane prior to takeoff.”

Lineup corrections should be made when computing takeoff performance, anytime runway access does not permit positioning the airplane at the threshold.

The takeoff distance / takeoff run (TOD / TOR) adjustment is made, based on the initial distance from the beginning of the runway to the main gear, since the screen height is measured from the main gear, as indicated by distance "A" in Figure

C12. The accelerate-stop distance (ASD) adjustment is based on the initial distance from the beginning of the runway to the nose gear, as indicated by distance "B" in Figure C12.

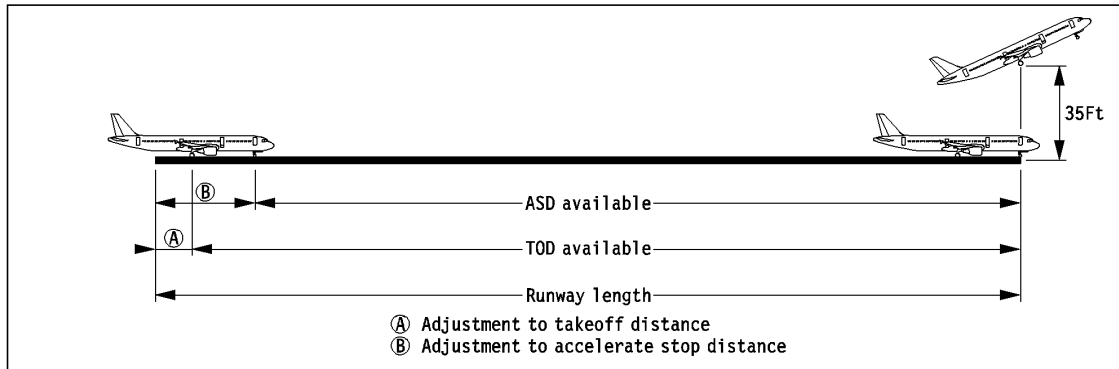

Figure C12: Lineup Corrections

Runways with displaced takeoff thresholds, or ample turning aprons, should not need further adjustment. Accountability is usually required for a 90° taxiway entry to the runway and a 180° turnaround on the runway. The following tables (C2 and C3) contain the minimum lineup distance adjustments for both the accelerate-go (TOD/TOR) and accelerate-stop (ASD) cases that result from a 90° turn onto the runway and a 180° turn maneuver on the runway. For further details, refer to the Airbus Performance Program Manual (PPM).

3.2.4.1. 90 Degree Runway Entry

90 Degree Runway Entry			
Aircraft Model	Maximum Effective Steering Angle	Minimum Line up Distance Correction	
		TODA (m)	ASDA (m)
A300 all models	58.3°	21.5	40.2
A310 all models	56°	20.4	35.9
A320 all models	75°	10.9	23.6
A319 all models	70°	11.5	22.6
A321 all models	75°	12.0	28.9
A330-200 (Mod 47500)	62°	22.5	44.7
A330-200 (Mod 46810)	55.9°	25.8	48.0
A330-300 (Mod 47500)	65°	22.9	48.3
A330-300 (Mod 46863)	60.5°	25.1	50.5
A340-200 (Mod 47500)	62°	23.3	46.5
A340-200 (Mod 46863)	59.6°	24.6	47.8
A340-300 (Mod 47500)	62°	24.4	50
A340-300 (Mod 46863)	60.6°	25.2	50.8
A340-500	65°	23.6	51.6
A340-600	67°	24.6	57.8

Table C2: 90° Lineup Distances

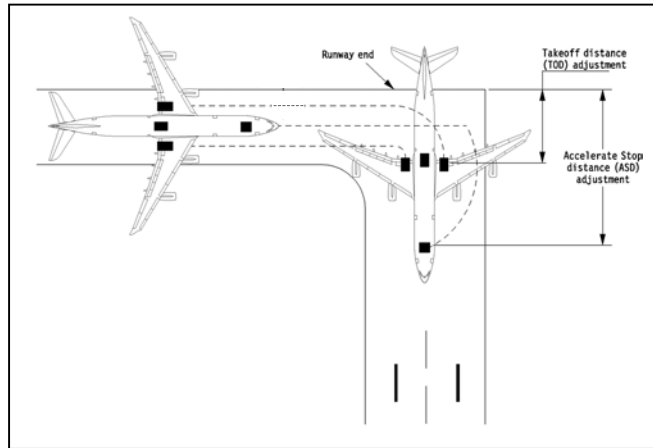

Figure C13: 90° taxiway

3.2.4.2. 180 Degree Turnaround

180 Degree Turnaround					
Aircraft Model	Minimum Line up Distance correction *		Required Minimum Runway width (m)	Nominal Line up Distance on a 60 m runway width **	
	TODA (m)	ASDA (m)		TODA (m)	ASDA (m)
A300 all models	26.5	45.2	66.1	38.0	56.7
A310 all models	23.3	38.8	61.6	29.0	44.5
A320 all models	16.5	29.1	28.7	16.5	29.1
A319 all models	15.1	26.2	31.1	15.1	26.2
A321 all models	20.9	37.8	33.1	20.9	37.8
A330-200 (Mod 47500)	30.1	52.3	68.2	43.3	65.5
A330-200 (Mod 46810)	31.9	54.1	81.6	55.0	77.1
A330-300 (Mod 47500)	33.2	58.5	70.0	47.9	73.3
A330-300 (Mod 46683)	34.2	59.6	78.8	55.4	80.8
A340-200 (Mod 47500)	31.5	54.8	71.4	47.4	70.6
A340-200 (Mod 46683)	32.2	55.4	76.6	51.8	75.1
A340-300 (Mod 47500)	34.1	59.7	76.0	53.3	78.9
A340-300 (Mod 46683)	34.4	60.0	79.2	55.9	81.5
A340-500	35.9	63.9	72.8	52.8	80.8
A340-600	41.1	74.3	76.6	60.7	93.9

Table C3: 180° Lineup Distances

* Lineup distance required to turn 180 degrees at maximum effective steering angle and end aligned with the centerline of the pavement. The indicated minimum runway width is required (Figure C14, left hand side).

** Lineup distance required to turn 180 degrees and realign the airplane on the runway centerline on a 60 m wide runway (Figure C14, right hand side).

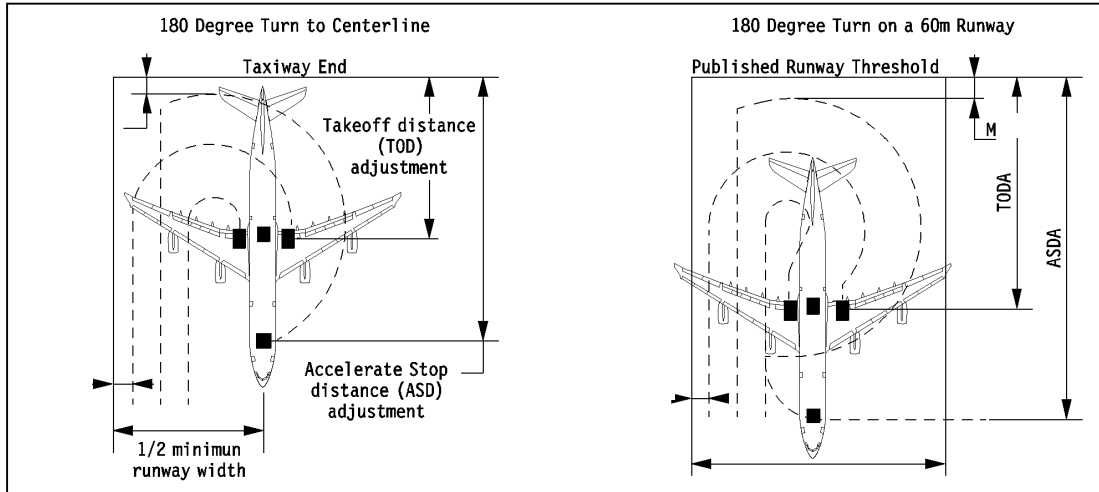

Figure C14: 180° Turnaround

3.2.5. Influence of V_1 on the Runway-Limited Takeoff Weight

Considering the runway requirements ($TOR \leq TORA$, $TOD \leq TODA$, and $ASD \leq ASDA$), a Maximum Takeoff Weight (MTOW) can be obtained for each runway limitation. As an example, when for a given takeoff weight the TOD is equal to the TODA, this takeoff weight is maximum regarding the Takeoff Distance limitation.

As previously seen, for a given takeoff weight, any increase of V_1 leads to shortening the TOD_{N-1} and TOR_{N-1} , and increasing the ASD, but has no influence on TOD_N and TOR_N .

Therefore, for a given runway (i.e. given TORA, TODA and ASDA), any increase in V_1 leads to an increase in the $MTOW_{TOD(N-1)}$ and $MTOW_{TOR(N-1)}$, and to a reduction in $MTOW_{ASD}$, but has no influence on $MTOW_{TOD(N)}$ and $MTOW_{TOR(N)}$.

The following graph (Figure C15) provides the runway-limited accelerate-go/stop takeoff weights as a function of V_1 . This graph clearly shows that a maximum takeoff weight is achieved in a particular range of V_1 .

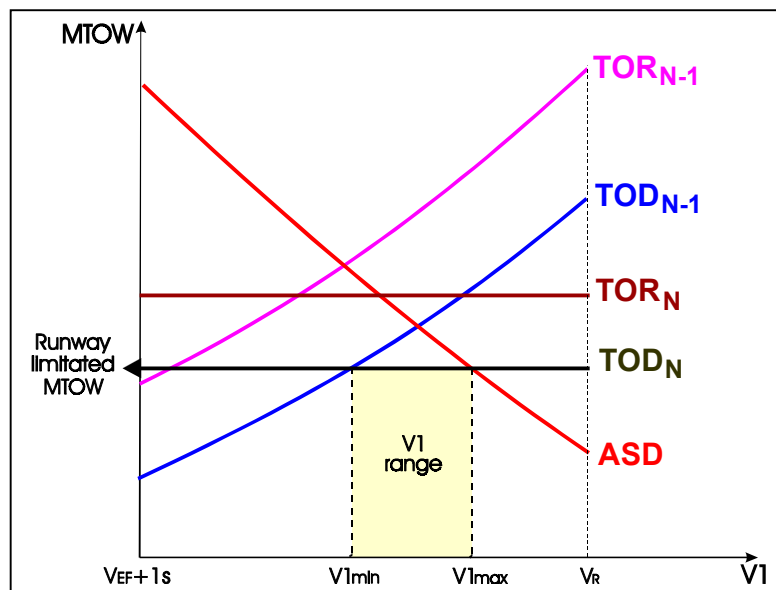

Figure C15: Runway-Limited Takeoff Weight

4. CLIMB AND OBSTACLE LIMITATIONS

4.1. Takeoff Flight Path

4.1.1. Definitions

JAR 25.111 Subpart B
JAR 25.115 Subpart B

FAR 25.111 Subpart B
FAR 25.115 Subpart B

“JAR/FAR 25.111

(a) The **takeoff path** extends from a standing start to a point at which the aeroplane is at a height:

- Of 1500 ft above the takeoff surface, or
- At which the transition from the takeoff to the en-route configuration¹ is completed and the final takeoff speed² is reached,

whichever point is higher”.

“JAR/FAR 25.115 (a)

The **takeoff flight path** begins 35 ft above the takeoff surface at the end of the takeoff distance.”

The **takeoff path** and **takeoff flight path** regulatory definitions assume that the aircraft is accelerated on the ground to V_{EF} , at which point the critical engine is made inoperative and remains inoperative for the rest of the takeoff. Moreover, the V_2 speed must be reached before the aircraft is 35 feet above the takeoff surface, and the aircraft must continue at a speed not less than V_2 , until it is 400 feet above the takeoff surface.

4.1.2. Takeoff Segments and Climb Requirements

JAR 25.121 Subpart B

FAR 25.121 Subpart B

The takeoff flight path can be divided into several segments. Each segment is characteristic of a distinct change in configuration, thrust, and speed. Moreover, the configuration, weight, and thrust of the aircraft must correspond to the most critical condition prevailing in the segment. Finally, the flight path must be based on the aircraft's performance without ground effect. As a general rule, the aircraft is considered to be out of the ground effect, when it reaches a height equal to its wing span.

¹ En route configuration: Clean configuration, Maximum Continuous Thrust (MCT) setting.

² Final takeoff speed: Speed greater than $1.25 V_s$, chosen equal to Green Dot speed (best climb gradient speed)

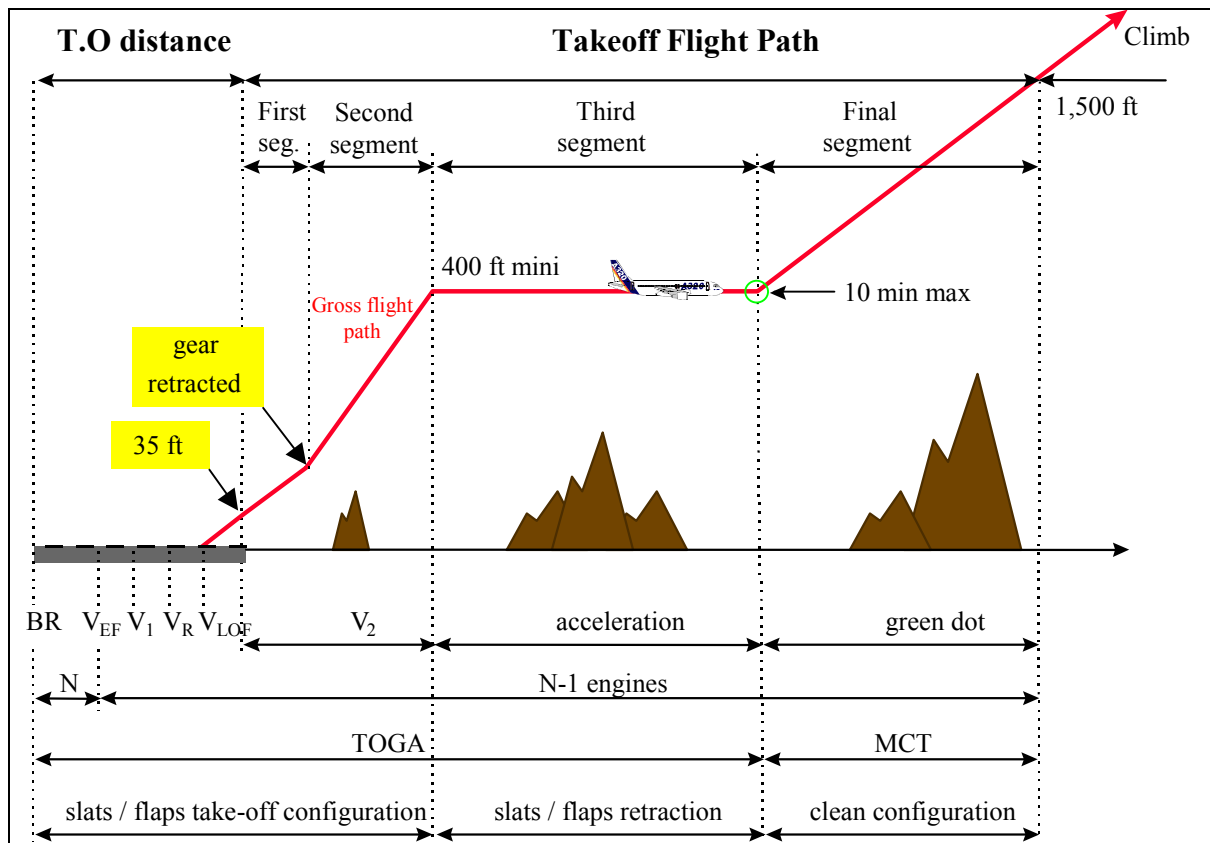

Figure C16: Takeoff Path and Definition of Various Segments

After an engine failure at V_{EF} , whatever the operational conditions, the aircraft must fulfill minimum climb gradients, as required by JAR/FAR 25.121.

The following Table (C4) summarizes the different requirements and aircraft status during the four takeoff segments : Minimum required climb gradient one-engine inoperative, flaps / slats configuration, engine rating, speed reference, landing gear configuration...

		FIRST SEGMENT	SECOND SEGMENT	THIRD SEGMENT	FINAL SEGMENT
Minimum climb gradient (N-1) engines	Twin	0.0%	2.4%	-	1.2%
	Quad	0.5%	3.0%	-	1.7%
Start when		V _{LOF} reached	Gear fully retracted	Acceleration height reached (min 400 feet)	En route configuration Achieved
Slats / Flaps Configuration		Takeoff	Takeoff	Slats / Flaps retraction	Clean
Engine rating		TOGA/FLEX	TOGA/FLEX	TOGA/FLEX	MCT
Speed reference		V _{LOF}	V ₂	Acceleration from V ₂ to Green Dot	Green Dot
Landing gear		Retraction	Retracted	Retracted	Retracted
Weight reference		Weight at the start of the gear retraction	Weight when the gear is fully retracted	Weight at the start of the acceleration segment	Weight at the end of the acceleration segment
Ground effect		Without	Without	Without	Without

Table C4: Takeoff Segment Characteristics

4.1.3. Minimum and Maximum Acceleration Heights

4.1.3.1. Minimum Acceleration Height

JAR 25.111 Subpart B

FAR 25.111 Subpart B

“JAR/FAR 25.111

(c)(2) *The aeroplane must reach V_2 before it is 35 ft above the takeoff surface and must continue at a speed not less than V_2 until it is 400 ft above the takeoff surface”*

“JAR/FAR 25.111

(c)(3) *At each point along the takeoff flight path, starting at the point at which the aeroplane reaches 400 ft above the takeoff surface, the available gradient of climb may not be less than:*

- *1.2% for a two-engined airplane*
- *1.7% for a four-engined airplane”*

So, below 400 feet, the speed must be maintained constant to a minimum of V_2 . Above 400 feet, the aircraft must fulfill a minimum climb gradient, which can be transformed into an acceleration capability in level flight. Therefore, the **regulatory minimum acceleration height is fixed to 400 feet** above the takeoff surface.

Nevertheless, during the acceleration segment, obstacle clearance must be ensured at any moment. Therefore, the **operational minimum acceleration height is equal to or greater than 400 feet** (Figure C16).

4.1.3.2. Maximum Acceleration Height

The Maximum Takeoff Thrust (TOGA) is certified for use for a maximum of 10 minutes, in case of an engine failure at takeoff, and for a maximum of 5 minutes with all engines operating.

The Maximum Continuous Thrust (MCT), which is not time-limited, can only be selected once the enroute configuration is achieved (i.e. when the aircraft is in clean configuration at green dot speed).

As a result, **the enroute configuration** (end of the third segment) **must be achieved within a maximum of 10 minutes after takeoff**, thus enabling the determination of a **maximum acceleration height** (Figure C16).

4.1.4. Takeoff Turn Procedure

Some airports are located in an environment of penalizing obstacles, which may necessitate turning to follow a specific departure procedure. Turning departures are subject to specific conditions.

The turn conditions differ between JAR and FAR regulations. Thus, the following paragraphs deal separately with both requirements.

JAR-OPS 1.495 Subpart G

“JAR-OPS 1.495

(c)(1) *Track changes shall not be allowed up to the point at which the net take-off flight path has achieved a height equal to one half the wingspan but not less than 50 ft above the elevation of the end of the take-off run available.”*

AIRCRAFT TYPE	WINGSPAN	Minimum height above end of TORA to start a track change = Max {Half of Wingspan , 50 ft}
A300-B2/B4/600	44.84 m (147 ft 1 in)	Half of wingspan = 74 ft
A310-200/300	43.90 m (144 ft 1 in)	Half of wingspan = 73 ft
A318/A319/A320/A321	34.10 m (111 ft 10 in)	Half of wingspan = 56 ft
A330-200/300	60.30 m (197 ft 10 in)	Half of wingspan = 99 ft
A340-200/300	60.30 m (197 ft 10 in)	Half of wingspan = 99 ft
A340-500/600	63.50 m (208 ft 2 in)	Half of wingspan = 105 ft

Table C5: Minimum Height to Initiate a Track Change

“JAR-OPS 1.495

(c)(1) Thereafter, up to a height of 400 ft it is assumed that the aeroplane is banked by no more than 15°. Above 400 ft height bank angles greater than 15°, but not more than 25° may be scheduled.” (see table C6)

“JAR-OPS 1.495

(c)(3) An operator must use special procedures, subject to the approval of the Authority, to apply increased bank angles of not more than 20° between 200 ft and 400 ft, or not more than 30° above 400 ft”

Maximum Bank angle during a turn (JAR)		
	Standard procedure	Specific approval
Below 200 ft	15°	15°
Between 200 ft and 400 ft	15°	20°
Above 400 ft	25°	30°

Table C6: Maximum Bank Angle During a Turn

FAR 121.189 Subpart I

“FAR 121.189

(f) For the purpose of this section, it is assumed that the airplane is not banked before reaching a height of 50 ft, [...] and thereafter that the maximum bank is not more than 15 degrees¹.”

¹ The FAA rule is similar to the ICAO annex 6 recommendations.

4.2. Obstacle Clearance

4.2.1. Gross and Net Takeoff Flight Paths

Most of the time, runways have surrounding obstacles which must be taken into account prior to takeoff, to ascertain that the aircraft is able to clear them. A vertical margin has to be considered between the aircraft and each obstacle in the takeoff flight path. This margin, based on a climb gradient reduction, leads to the definitions of the **Gross Takeoff Flight Path** and the **Net takeoff flight Path**.

JAR 25.115 Subpart B

FAR 25.115 Subpart B

GROSS Flight Path = Takeoff flight path actually flown by the aircraft, i.e.:

“JAR/FAR 25.115

(a) [...] from 35 ft above the takeoff surface at the end of the takeoff distance [to the end of the takeoff path]”

NET Flight Path = Gross takeoff flight path minus a mandatory reduction.

“JAR/FAR 25.115

(b) The net takeoff flight path data must be determined so that they represent the actual [Gross] takeoff flight path reduced at each point by a gradient equal to:

- 0.8% for two-engine aeroplanes
- 1.0% for four-engine aeroplanes”

Net Gradient = Gross Gradient - Gradient Penalty

	Gradient Penalty
Two-engine aircraft	0.8%
Four-engine aircraft	1.0%

Table C7: Values of Gradient Penalties

The gradient penalty between the net and the gross flight path must be taken into account during the first, second, and final takeoff segments (Figure C17).

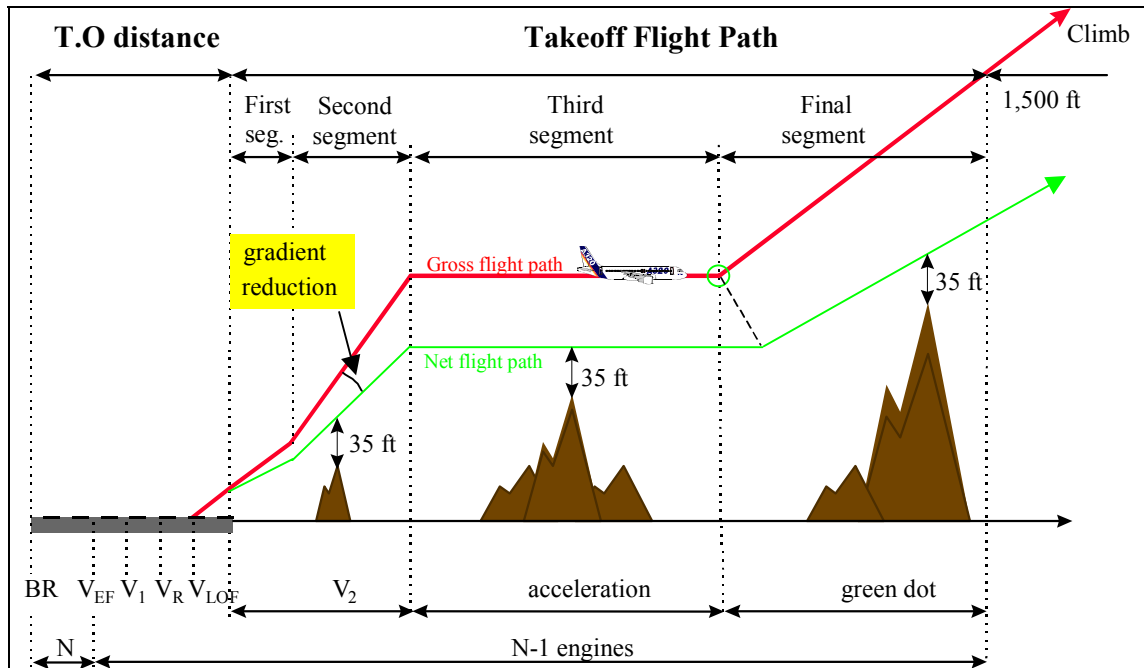

Figure C17: Gross and Net Takeoff Flight Paths

4.2.2. Obstacle Clearance during a Straight Takeoff

JAR-OPS 1.495 Subpart G

FAR 121.189 (d)(2) Subpart I

“JAR-OPS 1.495

(a) An operator shall ensure that the net take-off flight path clears all obstacles by a vertical distance of at least 35 ft.”

As an example, the minimum required climb gradient during the second segment must be 2.4% for a two-engine aircraft. But, as per regulation, the net flight path must clear any obstacle by at least 35 feet (Figure C17). This may sometimes require the second segment gradient to be greater than 2.4% and, consequently, the Maximum Takeoff Weight may have to be reduced accordingly. This is a case of obstacle limitation.

4.2.3. Obstacle Clearance during a Turn

Once again, the obstacle clearance margins during a turn differ between JAR and FAR regulations. The FAR regulation doesn't consider any additional vertical margin during a turn, as the bank angle is limited to 15°. The following rule is then purely JAR-OPS:

JAR-OPS 1.495 Subpart G

“JAR-OPS 1.495

(c)(2) Any part of the net take-off flight path in which the aeroplane is banked by more than 15° must clear all obstacles [...] by a vertical distance of at least 50 ft.”

	Obstacle clearance margin
Bank angle $\leq 15^\circ$	35 ft
Bank angle $> 15^\circ$	50 ft

Table C8: Minimum Vertical Clearance Between the Net Flight Path and the Obstacles

4.2.4. Loss of Gradient during a Turn

During a turn, an aircraft is not only subjected to its weight (W), but also to a horizontal acceleration force (F_a). The resulting force is called “apparent weight” (W_a), and its magnitude is equal to the load factor times the weight ($n_z \cdot W$).

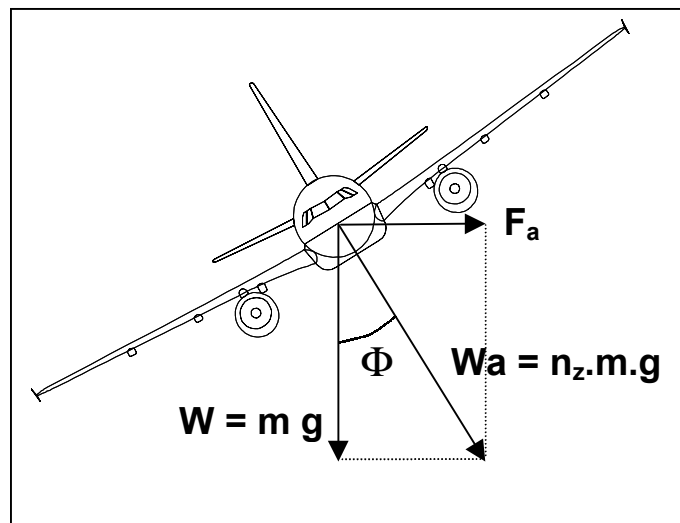

Figure C18: Load Factor in Turn

Considering the above Figure C18, the load factor (n_z) can be expressed versus the bank angle (Φ) as follows:

$$n_z = \frac{1}{\cos\phi}$$

So, as soon as the aircraft is banked, the load factor becomes greater than one. This induces a loss of climb gradient, as the climb angle can be expressed as follows (refer to the “Climb” chapter) :

$$\gamma^\circ = \frac{\text{Thrust}}{n_z \cdot \text{Weight}} - \frac{1}{L/D}$$

AMC-OPS 1.495

“AMC OPS 1.495

(c)(4) The Aeroplane Flight Manual generally provides a climb gradient decrement for a 15° bank turn. For bank angles of less than 15°, a proportionate amount should be

applied, unless the manufacturer or Aeroplane Flight Manual has provided other data.”

The loss of gradient versus the bank angle is provided in the Airbus Flight Manual (AFM), as well as in the Airbus Performance Program Manual (PPM) as shown in Figure C19.

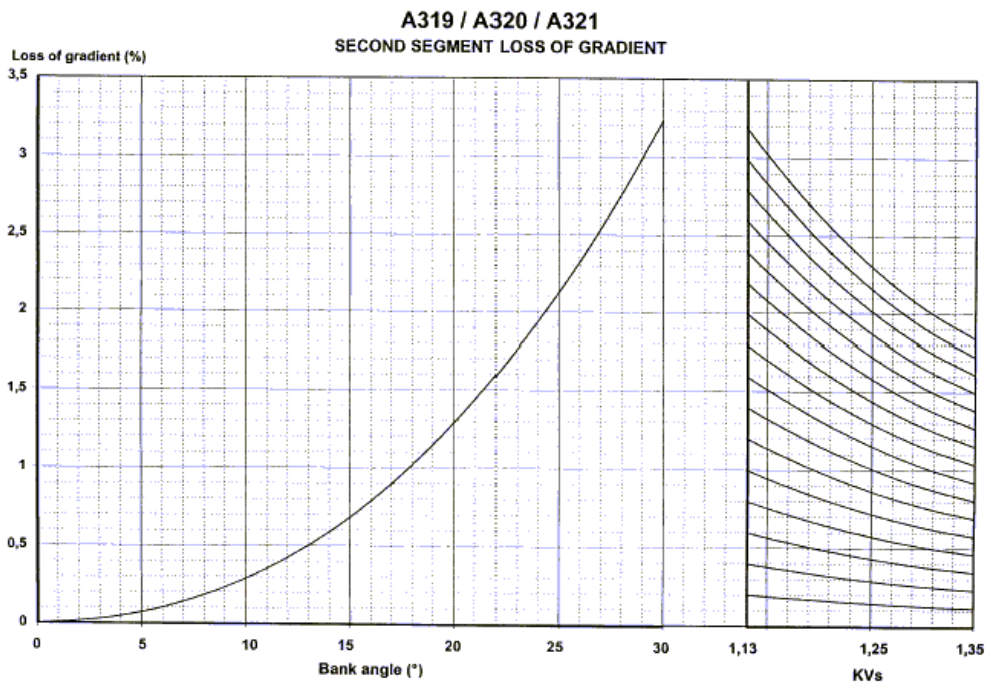

Figure C19: Loss of Gradient versus Bank Angle (A320 family example)

On airbus fly-by-wire aircraft, the autopilot limits the bank angle at takeoff with one engine inoperative to 15°. Some Engine Out Standard Instrument Departures (EOSID) require a turn to be performed with a bank angle of 20° or more. When a turn with more than a 15° bank angle must be carried out, the aircraft must be manually flown.

4.2.5. Takeoff Flight Path with Obstacles

Once the obstacles are taken into account, the maximum takeoff weight at brake release must be calculated so that the net flight path clears the most penalizing obstacle with a vertical margin of 35 feet (or 50 feet when the bank angle is greater than 15°).

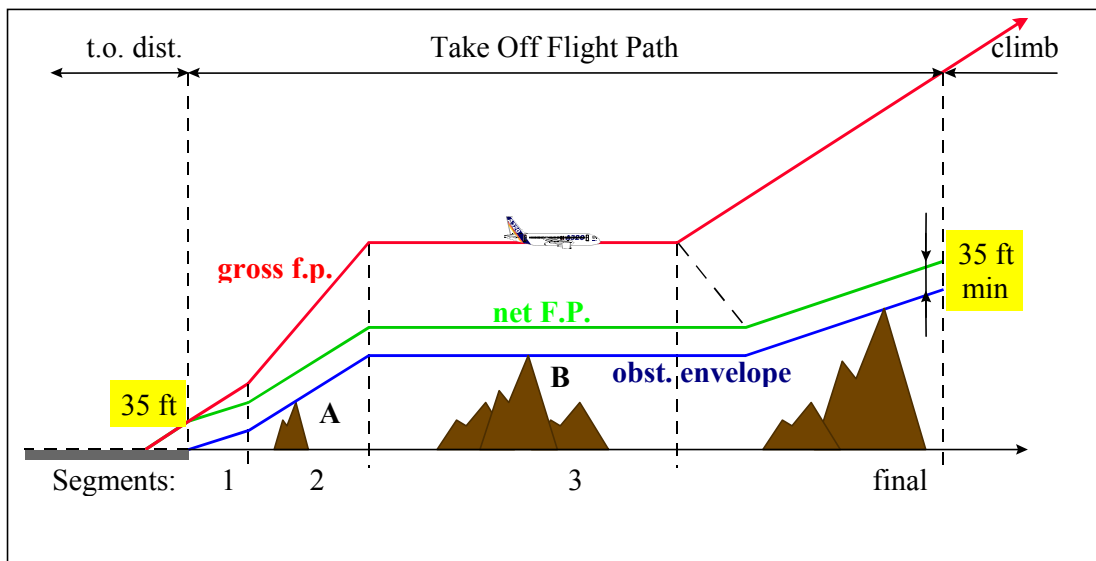

Figure C20: Takeoff Flight Path with Obstacles

Obstacle A (Figure C20), imposes a minimum Net second segment gradient and, therefore, a minimum Gross second segment gradient. This results in a takeoff weight limitation.

Obstacle B helps determine the minimum acceleration height. This height must be between 400 feet and the maximum acceleration height (10 minutes at TOGA). The minimum acceleration height ensures a vertical clearance of 35 feet (or 50 feet) between the net flight path and the obstacle.

The net acceleration segment is longer than the gross one, as the end of both segments is assumed to be reached after the same flight time.

4.2.6. Takeoff Funnel

The takeoff funnel represents an area surrounding the takeoff flight path, within which all obstacles must be cleared, assuming they are all projected on the intended track. The contours of this area, also called departure sector, differ between the JAR and the FAR regulations, and will be dealt with separately in the following section.

JAR-OPS 1.495 Subpart G
AMC-OPS 1.495

“JAR-OPS 1.495

(a) An operator shall ensure that the net take-off flight path clears all obstacles [...] by a horizontal distance of at least 90 m plus $0.125 \times D$, where D is the horizontal distance the aeroplane has traveled from the end of the take-off distance available or the end of the take-off distance if a turn is scheduled before the end of the take-off distance available. For aeroplanes with a wingspan of less than 60 m a horizontal obstacle clearance of half the aeroplane wingspan plus 60 m plus $0.125 \times D$ may be used.”

The semi-width at the start of the departure sector is a function of the aircraft's wingspan. The following Table (C9) provides the values for each aircraft type:

AIRCRAFT TYPE	WINGSPAN	Semi-width at the start of the departure sector (1/2 E ₀)
A300-B2/B4/600	44.84 m (147 ft 1 in)	83 m (271 ft)
A310-200/300	43.90 m (144 ft 1 in)	82 m (269 ft)
A318/A319/A320/A321	34.10 m (111 ft 10 in)	78 m (253 ft)
A330-200/300	60.30 m (197 ft 10 in)	90 m (296 ft)
A340-200/300	60.30 m (197 ft 10 in)	90 m (296 ft)
A340-500/600	63.50 m (208 ft 2 in)	90 m (296 ft)

Table C9: JAR-OPS Semi-Width at the Start of the Departure Sector

“JAR-OPS 1.495

(d) For those cases where the intended flight path does not require track changes of more than 15°, an operator need not consider those obstacles which have a lateral distance greater than:

- 300 m, if the pilot is able to maintain the required navigational accuracy through the obstacle accountability area, or
- 600 m, for flights under all other conditions.”

“JAR-OPS 1.495

(e) For those cases where the intended flight path does require track changes of more than 15°, an operator need not consider those obstacles which have a lateral distance greater than:

- 600 m, if the pilot is able to maintain the required navigational accuracy through the obstacle accountability area, or
- 900 m for flights under all other conditions.”

The **Required Navigational Accuracy** is defined in AMC-OPS 1.495. It can either be obtained via navigation aids, or by using external references in case of Visual Course guidance (VMC day flights).

The following Figures C21 and C22 represent the JAR-OPS departure sectors:

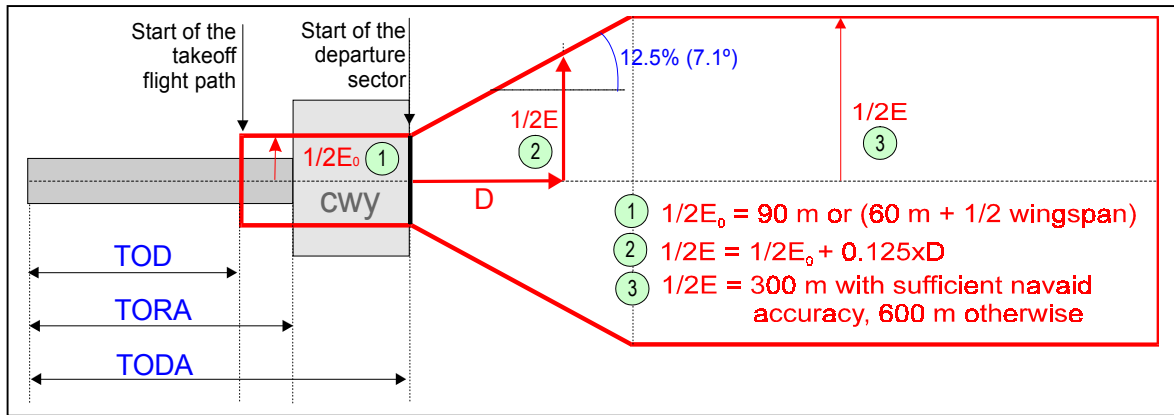

Figure C21: JAR-OPS Departure Sector (Track change $\le 15^\circ$)

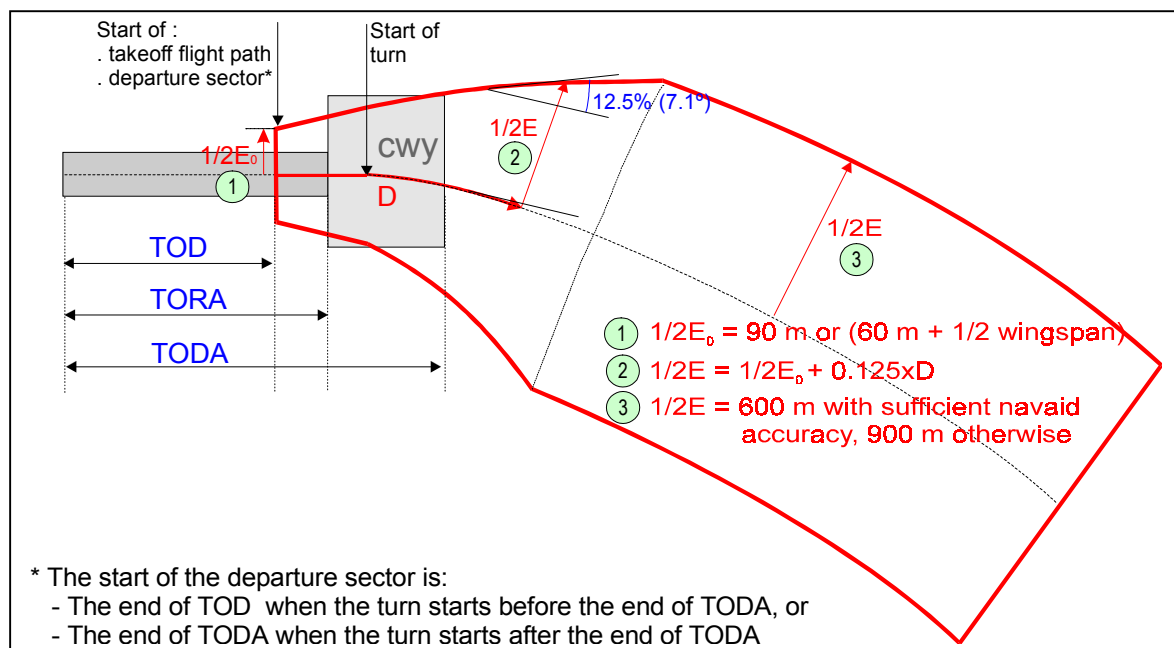

Figure C22: JAR-OPS Departure Sector (Track change $> 15^\circ$)

Note that the ICAO recommendations for the departure sector (Annex 6) are the same as the JAR-OPS definitions.

FAR 121.189 Subpart I

“FAR 121.189

(d)(2) No person operating a turbine engine powered transport category airplane may take off that airplane at a weight greater than that listed in the Airplane Flight Manual [...] that allows a net takeoff flight path that clears all obstacles [...] by at least 200 feet horizontally within the airport boundaries and by at least 300 feet horizontally after passing the boundaries.”

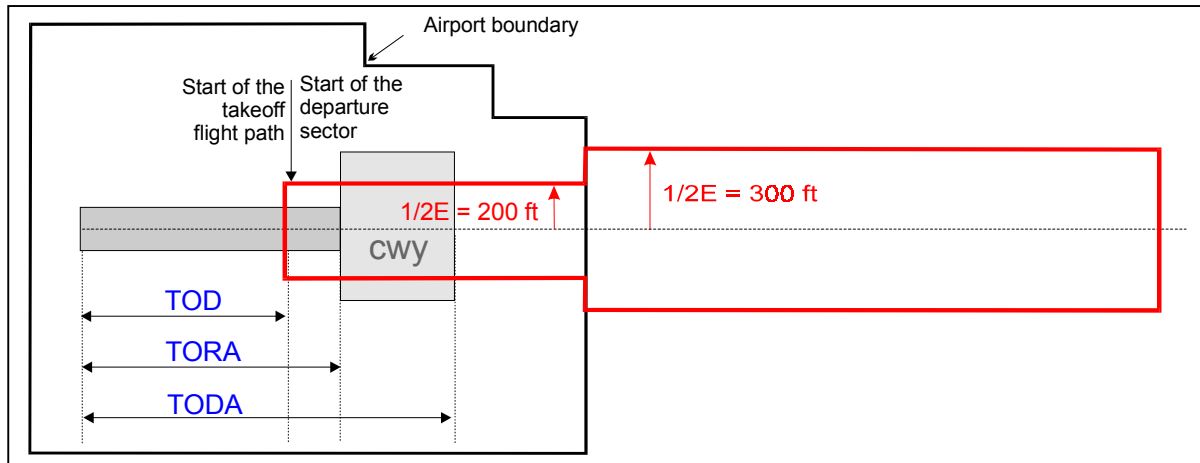

Figure C23: FAR Departure Sector

5. OUTSIDE ELEMENTS

Determination of the performance limited Takeoff Weight must be done considering the external conditions of the day. These conditions affect the MTOW, which can vary considerably from one day to the other.

JAR-OPS 1.490 Subpart G
 JAR 25.105 Subpart B
 JAR 25.237 Subpart B

FAR 121.189 (e) Subpart I
 FAR 25.105 Subpart B
 FAR 25.237 Subpart B

“JAR-OPS 1.490

(c) an operator must take account of the following [when determining the maximum takeoff mass]:

- Not more than 50% of the reported head-wind component or not less than 150% of the reported tailwind component;
- The pressure altitude at the aerodrome;
- The ambient temperature at the aerodrome;
- The runway slope in the direction of take-off;
- The runway surface condition and the type of runway surface“

5.1. Wind

The wind component along the runway axis is an important influencing factor for takeoff. It affects the takeoff ground speed and, therefore, the takeoff distances, which are reduced in case of headwind and increased in case of tailwind.

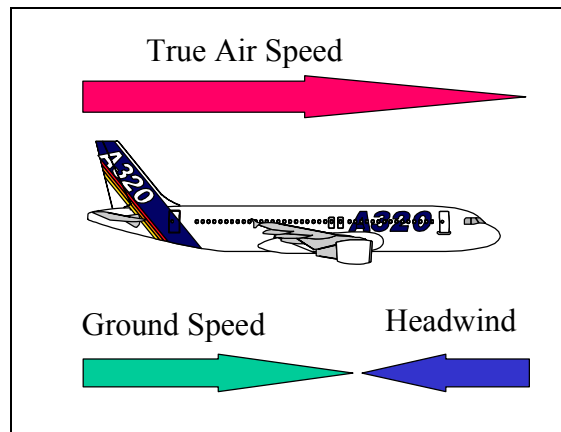

Figure C24: Headwind Effect on Ground Speed

The MTOW calculated prior to takeoff, must be determined considering **50% of the actual headwind component**, or **150% of the actual tailwind component**. This condition forms part of the Airbus performance software, so that an operator just has to consider the actual wind component for the MTOW determination.

JAR 25.237 Subpart B

FAR 25.237 Subpart B

“JAR/FAR 25.237

(a) A 90° cross component of wind velocity, demonstrated to be safe for take-off and landing, must be established for dry runways and must be at least 20 knots or 0.2 V_{S0}^1 , whichever is greater, except that it need not exceed 25 knots.”

The crosswind component does not affect takeoff performance. Nevertheless, it is necessary to demonstrate the safety of takeoff and landing procedures up to 25 knots of crosswind. The maximum demonstrated value must be published in the Aircraft Flight Manual.

5.2. Pressure Altitude

Pressure altitude influences airframe and engine performance. When the pressure altitude increases, the corresponding static pressure P_s and air density ρ decrease.

5.2.1. Effect on Aerodynamics

The force balance in level flight can be illustrated as follows:

$$\text{Weight} = m g = \text{Lift} = \frac{1}{2} \rho S T A S^2 C_L$$

¹ V_{S0} is the reference stall speed in clean configuration.

As a conclusion, when the pressure altitude increases for a given weight, the true air speed (TAS) must be increased to compensate for the air density reduction. Therefore, the takeoff distance is increased.

5.2.2. Effect on Engines

When the pressure altitude increases, the available takeoff thrust is reduced. Therefore, takeoff distances are longer and takeoff climb gradients are reduced.

5.2.3. Summary

When the pressure altitude ↗	⇒	{ Takeoff distances ↗
		{ Takeoff climb gradients ↘
	⇒	{ MTOW ↘

5.3. Temperature

5.3.1. Effect on Aerodynamics

When the Outside Air Temperature (OAT) increases, the air density ρ decreases. As mentioned above, the true air speed (TAS) must be increased to compensate for the air density reduction. As a result, the takeoff distance is increased.

5.3.2. Effect on Engines

The Takeoff thrust (TOGA) remains constant, equal to the Flat Rated Thrust, until the OAT reaches the Flat Rating Temperature (T_{ref}). Above this temperature, the takeoff thrust starts decreasing (Figure C25) .

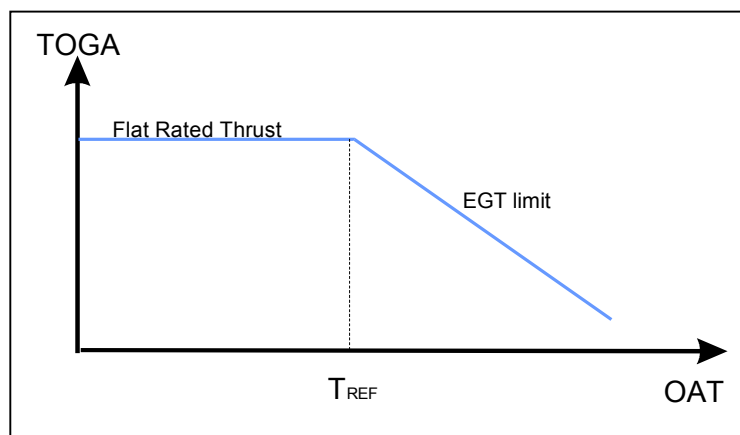

Figure C25: Engine Thrust versus Outside Air Temperature

Consequently, when the Outside Air Temperature increases, the takeoff distances are longer and takeoff climb gradients are reduced.

5.3.3. Summary

When the Outside Temperature ↗	⇒	{ Takeoff distances ↗	
		{ Takeoff climb gradients ↘	
	⇒	{ MTOW ↘	

5.4. Runway Slope

A slope is generally expressed in percentages, preceded by a plus sign when it is upward, or a minus sign when it is downward.

Airbus aircraft are all basically certified for takeoff on runways whose slopes are between -2% and +2%. Nevertheless, these values can be extended to higher limits for operations on particular runways, but it remains marginal as it requires additional certification tests.

From a performance point of view, an upward slope degrades the aircraft's acceleration capability and, consequently, increases takeoff distance. On the other hand, the stopping distance is shortened in case of a rejected takeoff. This is why, depending on the takeoff limitation, an upward slope can sometimes improve MTOW and sometimes lower it.

Upward slope	⇒	{ Takeoff distances ↗	
		{ Accelerate stop distance ↘	
Downward slope	⇒	{ Takeoff distances ↘	
		{ Accelerate stop distance ↗	

5.5. Runway Conditions (Dry, Damp, Wet, Contaminated)

JAR-OPS 1.480 Subpart F

The previously-discussed performance aspects only concerned dry and wet runways. But contaminants also affect takeoff performance, and have to be considered for takeoff weight calculation. The following section aims at defining the different runway states that can be encountered at takeoff.

5.5.1. Definitions

“JAR-OPS 1.480

(4) **Dry runway:** *A dry runway is one which is neither wet nor contaminated, and includes those paved runways which have been specially prepared with grooves or porous pavement and maintained to retain ‘effectively dry’ braking action even when moisture is present”*

“JAR-OPS 1.480

(3) **Damp runway:** *A runway is considered damp when the surface is not dry, but when the moisture on it does not give it a shiny appearance.”*

The FAA does not make any reference to damp runways, which are considered as wet, whereas **JAR-OPS 1.475** states that **a damp runway is equivalent to a dry one** in terms of takeoff performance. Recently, JAR 25 and JAR-OPS Study Groups came to the conclusion that a damp runway should be considered closer to a wet one than to a dry one in terms of friction coefficient (μ)¹. As of today, a JAA Notice for Proposed Amendment (NPA) is under discussion, so that in the future, a damp runway may have to be considered as wet.

“JAR-OPS 1.480

(10) **Wet runway:** *A runway is considered wet when the runway surface is covered with water or equivalent, [with a depth less than or equal to 3 mm], or when there is a sufficient moisture on the runway surface to cause it to appear reflective, but without significant areas of standing water.”*

In other words, a runway is considered to be **wet**, as soon as it has a **shiny appearance**, but without risk of hydroplaning due to standing water on one part of its surface. The water depth is assumed to be less than 3 mm.

For “**grooved**” or “**porous friction course**”² **wet runways**, specific friction coefficients wet (between μ_{dry} and μ_{wet}) can be used, if provided in the Aircraft Flight Manual. The resulting ASD improvement can sometimes result in higher takeoff weights than on smooth wet runways. Nevertheless, Airbus AFMs don’t provide any specific data for these runway types.

“JAR-OPS 1.480

(2) **Contaminated runway:** *A runway is considered to be contaminated when more than 25% of the runway surface area within the required length and width being used is covered by the following:”*

- **Standing water:** Caused by heavy rainfall and/or insufficient runway drainage with a depth of more than 3 mm (0.125 in).
- **Slush:** Water saturated with snow, which spatters when stepping firmly on it. It is encountered at temperature around 5° C, and its density is approximately 0.85 kg/liter (7.1 lb / US GAL).

¹ μ = friction coefficient = ratio of maximum available tire friction force and vertical load acting on a tire.

² Runways specially prepared and treated with a porous friction course (PFC) overlay

- **Wet snow:** If compacted by hand, snow will stick together and tend to form a snowball. Its density is approximately 0.4 kg/liter (3.35 lb / US GAL).
- **Dry snow:** Snow can be blown if loose, or if compacted by hand, will fall apart again upon release. Its density is approximately 0.2 kg/liter (1.7 lb / US GAL).
- **Compacted snow:** Snow has been compressed (a typical friction coefficient is 0.2).
- **Ice :** The friction coefficient is 0.05 or below.

5.5.2. Effect on Performance

There is a clear distinction of the effect of contaminants on aircraft performance. Contaminants can be divided into **hard** and **fluid** contaminants.

- **Hard** contaminants are : Compacted snow and ice.
They **reduce friction forces**.
- **Fluid** contaminants are : Water, slush, and loose snow.
They **reduce friction forces**, and cause **precipitation drag** and **aquaplaning**.

5.5.2.1. Reduction of Friction Forces

The friction forces on a dry runway vary with aircraft speed. Flight tests help to establish the direct relation between the aircraft's friction coefficient (μ) and the ground speed (Figure C26).

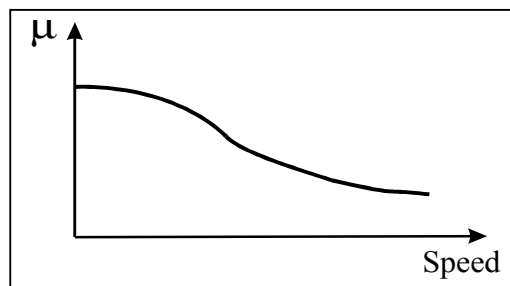

Figure C26: μ_{dry} versus aircraft's speed

Until recently, regulations stated that, for a **wet runway** and for a runway covered with **standing water** or **slush**, the aircraft's friction coefficient could be deduced from the one obtained on a dry runway, as follows:

$$\begin{aligned}\mu_{wet} &= \mu_{dry}/2 \text{ (limited to 0.4)} \\ \mu_{conta} &= \mu_{dry}/4\end{aligned}$$

This concerns A300, A300-600, A310, A320 (except A320-233), A321-100 (JAA certification only), A330-300 (JAA certification only) and A340 basic versions.

As of today, a new method, known as ESDU, has been developed and introduced by post-amendment 42 in JAR/FAR 25.109. The proposed calculation method of the μ_{wet} accounts for the tire pressure, the tire wear state, the type of runway and the anti-skid efficiency demonstrated through flight tests. The μ_{conta} (water and slush) results from an amendment based on a flight test campaign. The ESDU model concerns all aircraft types which are not mentioned above.

For snow-covered or icy runways, the following values are considered, whatever the aircraft type:

$$\mu_{\text{snow}} = 0.2$$

$$\mu_{\text{icy}} = 0.05$$

5.5.2.2. Effective μ and Reported μ

Airport authorities publish contaminated runway information in a document called “SNOWTAM”, which contains:

- The type of contaminant
- The mean depth for each third of total runway length
- The reported μ or braking action.

The reported μ is measured by such friction-measuring vehicles, as: Skidometer, Saab Friction Tester (SFT), MU-Meter, James Brake Decelerometer (JDB), Tapley meter, Diagonal Braked Vehicle (DBV). ICAO Airport Services Manual Part 2 provides information on these measuring vehicles.

The main problem is that the resulting friction forces of an aircraft (interaction tire/runway) depend on its weight, tire wear, tire pressure, anti-skid system efficiency and... ground speed. The only way to obtain the aircraft’s effective μ would be to use the aircraft itself in the same takeoff conditions, which is of course not realistic in daily operations.

Another solution is to use one of the above-mentioned vehicles, but these vehicles operate at much lower speeds and weights than an aircraft. Then comes the problem of correlating the figures obtained from these measuring vehicles (**reported μ**), and the actual braking performance of an aircraft (**effective μ**).

To date, scientists have been unsuccessful in providing the industry with reliable and universal values. But tests and studies are still in progress. This is why Airbus publishes contaminated runway information as a function of the type of contaminant and depth of contaminant, and not as a function of the aircraft’s effective μ . Regulation states that:

IEM OPS 1.485 Subpart F

“IEM OPS 1.485

(b) If the performance data has been determined on the basis of measured runway friction coefficient, the operator should use a procedure correlating the measured runway friction coefficient and the effective braking coefficient of friction of the aeroplane type over the required speed range for the existing runway conditions.”

5.5.2.3. Precipitation Drag

Precipitation drag is composed of:

- **Displacement drag:** Produced by the displacement of the contaminant fluid from the path of the tire.
- **Spray impingement drag:** Produced by the spray thrown up by the wheels (mainly those of the nose gear) onto the fuselage.

The effect of these additional drags is to :

- Improve the deceleration rate: Positive effect, in case of a rejected takeoff.
- Worsen the acceleration rate: Negative effect for takeoff.

So, the negative effect on the acceleration rate leads to limit the depth of a fluid contaminant to a maximum value. On the other hand, with a hard contaminant covering the runway surface, only the friction coefficient (effective μ) is affected, and the depth of contaminant therefore has no influence on takeoff performance.

5.5.2.4. Aquaplaning Phenomenon

The presence of water on the runway creates an intervening water film between the tire and the runway, leading to a reduction of the dry area (Figure C27). This phenomenon becomes more critical at higher speeds, where the water cannot be squeezed out from between the tire and the runway. Aquaplaning (or hydroplaning) is a situation where the tires of the aircraft are, to a large extent, separated from the runway surface by a thin fluid film. Under these conditions, tire traction drops to almost negligible values along with aircraft wheels' braking; wheel steering for directional control is, therefore, virtually ineffective.

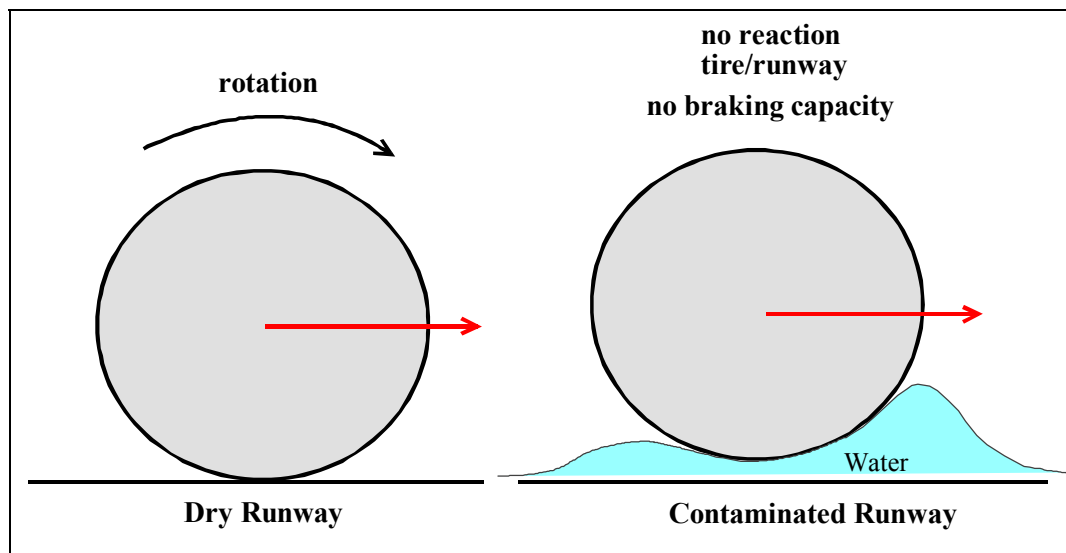

Figure C27: Hydroplaning Phenomenon

Aquaplaning speed depends on tire pressure, and on the specific gravity of the contaminant (i.e. how dense the contaminant is).

$$V_{\text{AQUAPLANING}} \text{ (kt)} = 34 (P_T/\sigma)^{0.5}$$

With

P_T = tire pressure (kg/cm²)

σ = specific gravity of the contaminant.

In other words, **the aquaplaning speed is a threshold at which friction forces are severely diminished.** Performance calculations on contaminated runways take into account the penalizing effect of hydroplaning.

5.5.3. Aircraft Manufacturer Data

The aircraft manufacturer has to provide relevant data for operations on runways contaminated by one of the above contaminants, as quoted below:

JAR 25X1591

“JAR 25X1591

(a)(c) Supplementary performance information for runways contaminated with standing water, slush, loose snow, compacted snow or ice must be furnished by the manufacturer in an approved document, in the form of guidance material, to assist operators in developing suitable guidance, recommendations or instructions for use by their flight crews when operating on contaminated runway surface conditions.”

“JAR 25X1591

(d) The information [on contaminated runways] may be established by calculation or by testing.”

As far as performance determination is concerned, Airbus provides guidance material for the following runway contaminants and maximum depths (Table C10):

Contaminant	Wet runway or equivalent	Contaminated runway
Water (fluid)	< 3 mm (0.12 in)	3 to 12.7 mm (0.5 in)
Slush (fluid)	< 2 mm (0.08 in)	2 to 12.7 mm (0.5 in)
wet snow (fluid)	< 4 mm (0.16 in)	4 to 25.4 mm (1 in)
dry snow (fluid)	< 15 mm (0.59 in)	15 to 50.8 mm (2 in)
Compacted snow (hard)	/	No depth limit
Ice (hard)	/	No depth limit

Table C10: Wet and Contaminated Runways

Note that takeoff is not recommended, when conditions are worse than the above-listed.

5.5.4. Takeoff Performance on Wet and Contaminated Runways

5.5.4.1. Acceleration Stop Distance

JAR 25X1591

The ASD definition on a contaminated runway is the same as on a wet runway. Reversers' effect may be taken into account in the ASD calculation, as soon as the surface is not dry. The distances can either be established by calculation or testing.

5.5.4.2. Takeoff Distance and Takeoff Run

JAR 25X1591
IEM-OPS 1.495 (b)

The TOD and TOR definitions on a contaminated runway are similar to the ones on a wet runway. They can either be established by calculation or testing.

5.5.4.3. Takeoff Flight Path

JAR-OPS 1.495 Subpart G	FAR 121.189
IEM-OPS 1.495 Subpart G	
JAR 25.115	FAR 25.115

“JAR-OPS 1.495

(a) *The net flight path must clear all relevant obstacles by a vertical distance of 35 ft.*”

“JAR 25.115

(a) *The **takeoff flight path** begins 35 ft above the takeoff surface at the end of the takeoff distance.*”

On a wet or contaminated runway, the screen height (height at the end of the TOD) is 15 feet. The net takeoff flight path starts at 35 feet at the end of the TOD. So, the gross flight path starts at 15 feet while the net flight path starts at 35 feet at the end of the TOD (see Figure C28).

“IEM-OPS 1.495

When taking off on a wet or a contaminated runway and an engine failure occurs at V_1 , this implies that the aeroplane can initially be as much as 20 ft below the net takeoff flight path, and therefore may clear close-in obstacles by only 15 ft.”

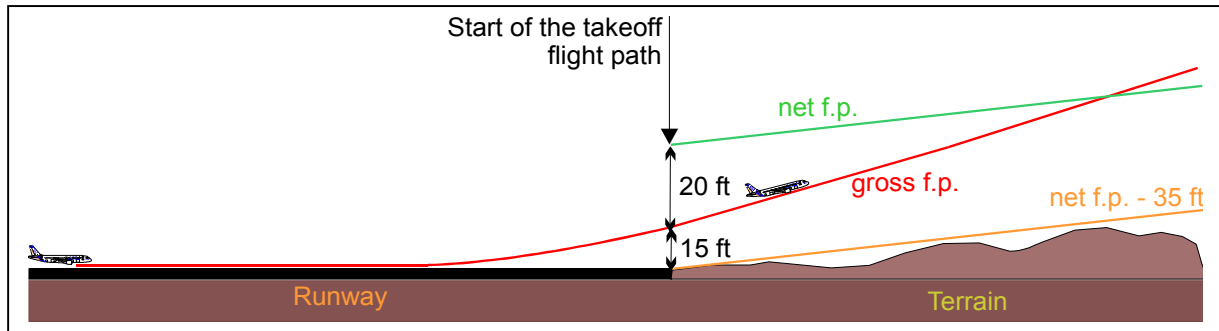

Figure C28: Gross and Net Takeoff Flight Paths on Wet and Contaminated Runways

While the net flight path clears the obstacles by 35 feet all along the takeoff flight path, the gross flight path can initially be at less than 35 feet above close-in obstacles.

5.5.4.4. Takeoff Weight

The TOD and ASD requirements differ between wet and contaminated runways on one side, and dry runways on the other side.

Indeed, on wet and contaminated runways, the screen height is measured at 15 feet rather than 35 feet on dry runways. Moreover, the use of reverse thrust is allowed for ASD determination on wet and contaminated runways, whereas it is forbidden to take it into account for the ASD determination on dry runways.

Therefore, it is possible to obtain shorter TODs and ASDs on wet and contaminated runways than on dry runways for the same takeoff conditions. Thus, it is possible to obtain higher takeoff weights on surfaces covered with water, slush, or snow than on dry runways. This is why the regulation indicates that:

JAR-OPS 1.490 Subpart G

“JAR-OPS 1.490

(b)(5) On a wet or contaminated runway, the takeoff mass must not exceed that permitted for a takeoff on a dry runway under the same conditions”.

6. MAXIMUM TAKEOFF WEIGHT DETERMINATION

6.1. Speed Optimization Process

Airbus recommends that the MTOW on a given runway and given conditions be computed by optimizing both the V_1/V_R ratio and the V_2/V_S ratio.

The performance software provided by Airbus automatically carries out this optimized computation, whose aim is to achieve the highest possible MTOW. This optimization process is described in **Appendix 2** of this manual.

6.2. Regulatory Takeoff Weight Chart (RTOW Chart)

To determine the regulatory takeoff weight for repetitive takeoff planning, it is mandatory to provide pilots with data, which enable quick calculations of the Maximum Allowed Takeoff Weight and its associated speeds. This can be done via ground or onboard computerized systems, such as the LPC (Less Paper Cockpit: see **Appendix 3**), or through paper documents.

These paper documents are referred to as “**Regulatory TakeOff Weight**” charts (**RTOW**). The charts must be generated for each runway heading, and can be produced for different takeoff conditions at the convenience of the applicant (temperature, wind, QNH, flap setting, runway status, inoperative items).

They provide the:

- Maximum Takeoff Weight (MTOW)
- Takeoff speeds (V_1, V_R, V_2)
- Limitation code
- Minimum and maximum acceleration heights.

Figure C29 shows an example of an A319 RTOW chart.

Example: MTOW and speeds determination

DATA

- Takeoff from Paris-Orly, Runway 08
- Slat/Flap configuration: 1+F
- OAT = 24°C
- Wind = Calm
- QNH = 1013 hPa
- Air conditioning: Off
- Runway state: Dry

RESULT

- MTOW = 73.6 tons
- $V_1 = 149$ Kt, $V_R = 149$ Kt, $V_2 = 153$ Kt
- MTOW limited by: second segment and obstacle(2/4)

Note: In case of deviation from the chart reference conditions (QNH, air conditioning...), corrections have to be applied to the MTOW and the speeds.

A319131 - JAA		IAE V2522-A5 engines		PARIS - (ORLY)		08		17.0.0 30-AUG-00 AD131A04 *V 9			
QNH 1013.25 HPA				Elevation 277 FT TORA 3320 M		4 obstacles		DRY			
Air cond. Off				Isa temp 14 C TODA 3320 M							
Anti-icing Off				rwy slope 0.07% ASDA 3320 M							
OAT		CONF 1+F									
C	TAILWIND -10 KT		TAILWIND -5 KT		WIND 0 KT		HEADWIND 10 KT		HEADWIND 20 KT		
	72.0 4/4 146/46/51	73.4 2/4 148/48/53	74.8 2/4 153/53/58	75.6 2/4 157/57/62	76.3 2/4 161/61/65	71.6 4/4 146/46/51	73.0 4/4 147/47/52	74.4 2/4 152/52/57	75.2 2/4 156/56/60	75.9 2/4 159/59/64	
14	71.2 4/4 145/45/50	72.5 4/4 146/46/51	74.0 2/4 150/50/55	74.9 2/4 154/54/59	75.6 2/4 157/57/62	71.2 4/4 145/45/50	72.5 4/4 146/46/51	74.0 2/4 150/50/55	74.9 2/4 154/54/59	75.6 2/4 157/57/62	
24	71.0 4/4 149/49/54	72.1 4/4 145/45/50	73.6 2/4 149/49/53	74.5 2/4 152/52/57	75.2 2/4 156/56/61	71.0 4/4 149/49/54	72.1 4/4 145/45/50	73.6 2/4 149/49/53	74.5 2/4 152/52/57	75.2 2/4 156/56/61	
34	70.8 4/4 148/48/53	71.7 4/4 145/45/50	73.1 2/4 147/47/52	74.1 2/4 151/51/56	74.9 2/4 154/54/59	70.8 4/4 148/48/53	71.7 4/4 145/45/50	73.1 2/4 147/47/52	74.1 2/4 151/51/56	74.9 2/4 154/54/59	
44	70.5 4/4 148/48/52	71.7 4/4 150/50/55	72.7 2/4 146/46/51	73.7 2/4 149/49/54	74.5 2/4 153/53/57	70.5 4/4 148/48/52	71.7 4/4 150/50/55	72.7 2/4 146/46/51	73.7 2/4 149/49/54	74.5 2/4 153/53/57	
54	70.4 4/6 147/47/51	71.5 4/4 149/49/54	72.0 2/4 142/43/48	72.1 4/8 144/49/54	72.0 2/4 136/43/48	70.4 4/6 147/47/51	71.5 4/4 149/49/54	72.0 2/4 142/43/48	72.1 4/8 144/49/54	72.0 2/4 136/43/48	
56	69.5 4/4 146/46/51	70.6 4/4 148/48/53	71.3 2/4 142/43/48	71.4 4/8 146/49/54	71.3 2/4 136/43/48	69.5 4/4 146/46/51	70.6 4/4 148/48/53	71.3 2/4 142/43/48	71.4 4/8 146/49/54	71.3 2/4 136/43/48	
58	68.3 4/4 145/45/50	69.4 4/4 147/47/52	70.4 4/4 144/44/48	71.4 2/4 147/47/51	71.6 2/4 146/47/52	68.3 4/4 145/45/50	69.4 4/4 147/47/52	70.4 4/4 144/44/48	71.4 2/4 147/47/51	71.6 2/4 146/47/52	
60	67.2 4/4 144/44/49	68.2 4/4 146/46/50	69.3 2/4 143/43/47	70.2 2/4 146/46/50	71.0 2/4 149/49/54	67.2 4/4 144/44/49	68.2 4/4 146/46/50	69.3 2/4 143/43/47	70.2 2/4 146/46/50	71.0 2/4 149/49/54	
62	66.0 4/4 142/42/47	67.0 4/4 145/45/49	68.2 2/4 141/41/46	69.1 2/4 145/45/49	69.8 2/4 148/48/53	66.0 4/4 142/42/47	67.0 4/4 145/45/49	68.2 2/4 141/41/46	69.1 2/4 145/45/49	69.8 2/4 148/48/53	
64	64.8 4/4 141/41/46	65.7 4/4 139/39/43	67.0 2/4 140/40/45	67.9 2/4 144/44/48	68.6 2/4 147/47/51	64.8 4/4 141/41/46	65.7 4/4 139/39/43	67.0 2/4 140/40/45	67.9 2/4 144/44/48	68.6 2/4 147/47/51	
66	63.6 4/4 140/40/44	64.6 4/4 138/38/42	65.9 2/4 140/40/44	66.7 2/4 143/43/47	67.4 2/4 146/46/50	63.6 4/4 140/40/44	64.6 4/4 138/38/42	65.9 2/4 140/40/44	66.7 2/4 143/43/47	67.4 2/4 146/46/50	
68	62.4 4/4 139/39/43	63.4 4/4 137/37/41	64.7 2/4 139/39/43	65.5 2/4 142/42/46	66.1 2/4 145/45/50	62.4 4/4 139/39/43	63.4 4/4 137/37/41	64.7 2/4 139/39/43	65.5 2/4 142/42/46	66.1 2/4 145/45/50	
70	61.2 4/4 138/38/42	62.2 4/4 136/36/40	63.4 2/4 138/38/42	64.2 2/4 141/41/45	64.8 2/4 144/44/48	61.2 4/4 138/38/42	62.2 4/4 136/36/40	63.4 2/4 138/38/42	64.2 2/4 141/41/45	64.8 2/4 144/44/48	
72	60.0 4/4 137/37/41	61.0 4/4 135/35/39	62.2 2/4 137/37/41	62.9 2/4 140/40/44	63.5 2/4 143/43/47	60.0 4/4 137/37/41	61.0 4/4 135/35/39	62.2 2/4 137/37/41	62.9 2/4 140/40/44	63.5 2/4 143/43/47	
74	58.8 4/4 136/36/40	59.8 4/4 134/34/38	60.9 2/4 136/36/40	61.7 2/4 139/39/43	62.2 2/4 142/42/46	58.8 4/4 136/36/40	59.8 4/4 134/34/38	60.9 2/4 136/36/40	61.7 2/4 139/39/43	62.2 2/4 142/42/46	
76	57.5 4/4 135/35/40	58.5 4/4 133/33/37	59.7 2/4 135/35/39	60.3 2/4 138/38/42	60.9 2/4 141/41/45	57.5 4/4 135/35/40	58.5 4/4 133/33/37	59.7 2/4 135/35/39	60.3 2/4 138/38/42	60.9 2/4 141/41/45	
78	56.1 4/4 129/29/34	57.2 4/4 131/31/35	58.4 2/4 134/34/38	59.0 2/4 137/37/41	59.6 2/4 140/40/44	56.1 4/4 129/29/34	57.2 4/4 131/31/35	58.4 2/4 134/34/38	59.0 2/4 137/37/41	59.6 2/4 140/40/44	
79	55.5 4/4 130/30/34	56.6 4/4 130/30/35	57.7 2/4 134/34/38	58.4 2/4 137/37/41	58.9 2/4 140/40/44	55.5 4/4 130/30/34	56.6 4/4 130/30/35	57.7 2/4 134/34/38	58.4 2/4 137/37/41	58.9 2/4 140/40/44	
LABEL FOR INFLUENCE		MTOW(1000 KG) codes V1min/VR/V2 (kt)		VMC LIMITATION		Tref (OAT) = 54 C Tmax (OAT) = 54 C		Min acc height 438 FT Max acc height 1674 FT		Min QNH alt 715 FT Max QNH alt 1951 FT	
DW (1000 KG) DTFLEX DVI-DVR-DV2 (KT) (TVMC OAT C) DW (1000 KG) DTFLEX DVI-DVR-DV2 (KT)		LIMITATION CODES: 1=1st segment 2=2nd segment 3=runway length 4=obstacles 5=tire speed 6=brake energy 7=max weight 8=final take-off 9=VMU						Min V1/VR/V2 = 105/11/17 CHECK VMU LIMITATION Correct. V1/VR/V2 = 1.0 KT/1000 KG			

Figure C29: A319 RTOW Chart Example

7. FLEXIBLE AND DERATED TAKEOFF

The aircraft **actual takeoff weight is often lower than the maximum regulatory takeoff weight**. Therefore, in certain cases, it is possible to takeoff at a thrust less than the Maximum Takeoff Thrust. It is advantageous to adjust the thrust to the actual weight, as it **increases engine life and reliability**, while **reducing maintenance and operating costs**.

These takeoff operations generally fall into two categories: Those using the reduced thrust concept, known as flexible takeoffs in the Airbus world, and those using a specific derated thrust level named derated takeoffs.

7.1. Flexible Takeoff

A takeoff at **reduced thrust** is called a **flexible takeoff**, and the corresponding thrust is called **flexible thrust**.

AMJ 25-13

AC 25-13

7.1.1. Definition

“AMJ 25-13 / AC 25-13

(4)(c) Reduced takeoff thrust, for an aeroplane, is a takeoff thrust less than the takeoff (or derated takeoff) thrust. The aeroplane takeoff performance and thrust setting are established by approved simple methods, such as adjustments, or by corrections to the takeoff thrust setting and performance.”

In this case, **“the thrust for takeoff is not considered as a takeoff operating limit.”**

As shown in Figure C30, the actual takeoff weight is less than the maximum permissible takeoff weight obtained from a RTOW chart. Therefore, it is possible to determine the temperature at which the needed thrust would be the maximum takeoff thrust for this temperature. This temperature is called **“flexible temperature (T_{Flex})”** or **“assumed temperature”**. Moreover:

“AMJ 25-13 / AC 25-13

(5)(a) The reduced takeoff thrust setting

(2) Is based on an approved takeoff thrust rating for which complete aeroplane performance data is provided

(3) Enables compliance with the aeroplane controllability requirements in the event that takeoff thrust is applied at any point in the takeoff path

(4) Is at least 75% of the maximum takeoff thrust for the existing ambient conditions”

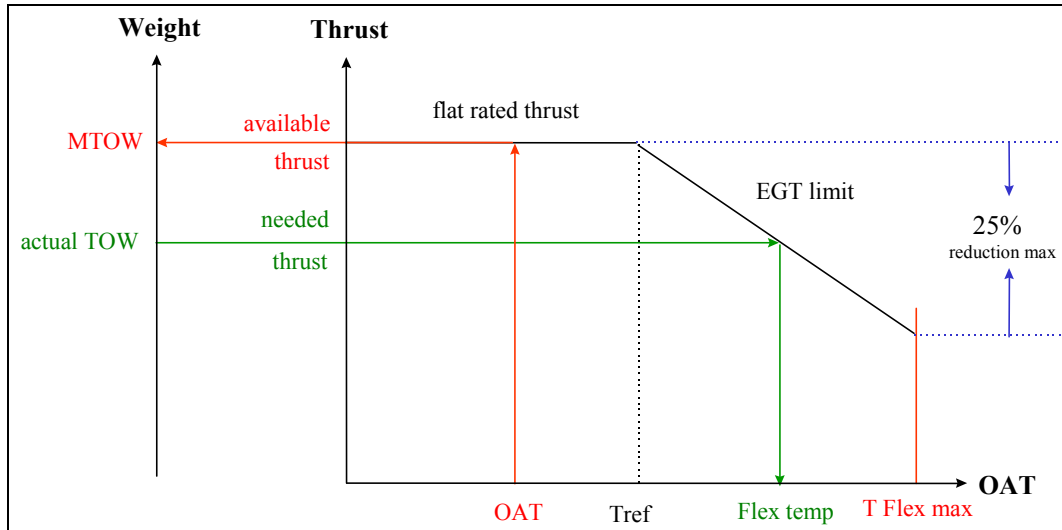

Figure C30: Flexible Temperature Principle

Consequently, the flexible temperature is the input parameter through which the engine monitoring computer adapts the thrust to the actual takeoff weight. This method is derived from the approved maximum takeoff thrust rating, and thus uses the same certified minimum control speeds.

In addition, thrust reduction **cannot exceed 25% of the maximum takeoff thrust**, thus leading to a **maximum flexible temperature**, as shown in Figure C30.

To comply with the above requirements, flexible takeoff is only possible when the flexible temperature fulfils the following three conditions:

$$\begin{aligned}
 &T_{Flex} > T_{REF} \\
 &T_{Flex} > OAT \\
 &T_{Flex} \leq T_{Flex Max}
 \end{aligned}$$

Regulations require operators to conduct periodic takeoff demonstrations, using the maximum takeoff thrust setting, in order to check takeoff parameters (N1, N2, EPR, EGT). The time interval between takeoff demonstrations may be extended, provided an approved engine condition-monitoring program is used.

7.1.2. Flexible Takeoff and Runway State

“AMJ 25-13 / AC 25-13

(f) The AFM states that [reduced thrust takeoffs] are not authorised on contaminated runways and are not authorised on wet runways unless suitable performance accountability is made for the increased stopping distance on the wet surface”.

Airbus operational documentation (RTOW, FCOM) provides performance information for flexible takeoffs on wet runways. As a result, a **flexible takeoff is allowed on a wet runway, while it is forbidden on a contaminated one.**

7.1.3. Flexible Temperature Determination

The following example illustrates how to determine a flexible temperature, with the use of a RTOW chart (Figure C29).

Example: Flexible Temperature and Speeds Determination

DATA

- Takeoff from Paris-Orly, Runway 08
- Slat/Flap configuration: 1+F
- Actual TOW = 66 tons
- OAT = 24°C
- Wind = +20 Kt headwind
- QNH = 1013 hPa
- Air conditioning: Off
- Runway state: Dry

RESULT

- Flex Temp = 68°C
- $V_1 = 145$ Kt, $V_R = 145$ Kt, $V_2 = 150$ Kt

Note: In case of deviation from the chart reference conditions (QNH, air conditioning...), corrections have to be applied to the flexible temperature.

7.1.4. Flexible Takeoff Procedure

To carry out a flexible takeoff, which is always at the discretion of the pilot, a flexible temperature has to be determined from an RTOW chart computed with no derate or an equivalent computerized system. This temperature value must then be entered in the MCDU (Multipurpose Control and Display Unit) during the takeoff preparation phase (Figure C31). At the brake release point, the thrust throttles must be pushed to the FLX position (Figure C32) as per the Standard Operating Procedure (SOP). TOGA thrust remains available at any moment during the takeoff phase. But, in the event of an engine failure after V_1 , its selection is not required.

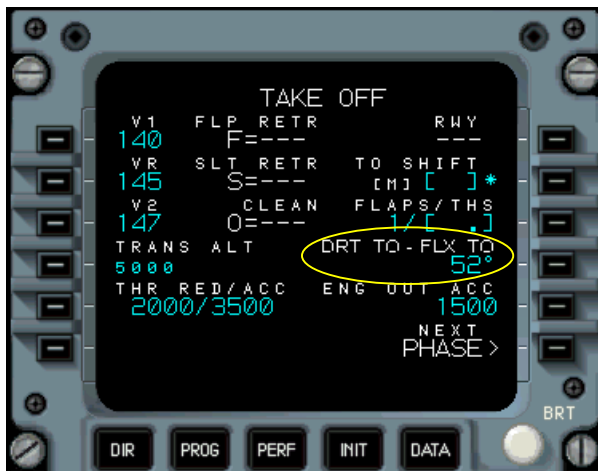

Figure C31: MCDU Takeoff Performance Page

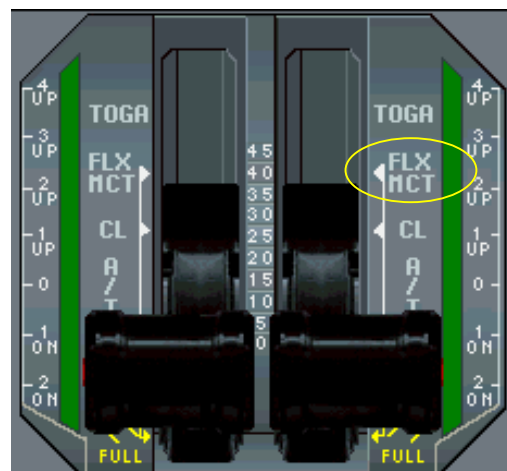

Figure C32: Thrust Throttle Positions

7.2. Derated Takeoff

7.2.1. Definition

AMJ 25-13

AC 25-13

“AMJ 25-13 / AC 25-13

(4)(b) Derated takeoff thrust, for an aeroplane, is a takeoff thrust less than the maximum takeoff thrust, for which exists in the AFM a set of separate and independent takeoff limitations and performance data that complies with all requirements of Part 25.”

In this case, **“the thrust for takeoff is considered as a normal takeoff operating limit.”**

For a derated takeoff, the limitations, procedures and performance data must be included in the Aircraft Flight Manual (AFM). For each derate level, a specific RTOW chart can be established for a given runway, taking into account such new limitations as the minimum control speeds.

7.2.2. Minimum Control Speeds with Derated Thrust

A given derate level corresponds to the basic maximum thrust reduced by a given percentage. Therefore, the new maximum available thrust at any point of the takeoff flight path is cut back, compared to the non-derated thrust. New minimum control speeds (V_{MCG} , V_{MCA}) can then be established, as per JAR/FAR 25.149.

A reduction in the minimum control speeds sometimes generates a takeoff performance benefit (higher MTOW) when taking-off on a short runway. Indeed, the decision speed V_1 is the maximum speed at which it is still possible to reject the takeoff and stop the aircraft within the runway limits. Nevertheless, V_1 must be greater than V_{MCG} , and the Accelerate Stop Distance is often the most constraining limitation on a short runway. A reduction of the V_{MCG} can then permit a reduction of the ASD for a given takeoff weight, and lead to better takeoff performance when the MTOW without derate is ASD/V_{MCG} limited.

Figure C33 illustrates A340 performance with and without derated thrust (from 4% to 24%). In this example, the optimum derate level (highest MTOW) corresponds to 20% of derate.

A340313 - JAA		CFM56-5C4 engines		EXAMPLE			36	18.0.0 02-NOV-01 AA313B02 V 9
Wind 0 KT		QNH 1013.25 HPA		Elevation 0 FT TORA 3000 M		0 obstacle		WATER 1/4"
Air cond. AC OFF		Anti-icing AI OFF		Isa temp 15 C TODA 3000 M			CONF 3	
All reversers inoperative		Dry check		rwy slope 0.00% ASDA 3000 M				
OAT	NO DERATE	D04	D08	D12	D16	D20	D24	
C								
20	195.8 3/3 130/31/43	205.1 3/3 128/29/41	208.2 3/9 126/30/40	216.0 3/9 125/34/43	220.4 3/9 123/36/44	227.9 3/9 121/40/46	223.9 3/9 121/39/45	

Figure C33: Takeoff Performance with and without Derate

7.2.3. Derated Takeoff and Runway State

A derated takeoff is considered to be a normal takeoff with the engines at their normal operating limits. New limitations, procedures, and performance data are provided in the AFM for each derate level and each runway surface. Therefore, it is possible to determine MTOW on a dry, wet, or contaminated runway, simply by using a specific takeoff chart established for a specific derate level and a specific runway state (Figure C34).

So, derated takeoff is allowed on both a wet and contaminated runway.

A340313 - JAA		CFM56-5C4 engines		EXAMPLE			36	18.0.0 05-NOV-01 AA313B02 V 9
QNH 1013.25 HPA		Air cond. AC OFF		Elevation 0 FT TORA 3000 M		0 obstacle		WATER 1/4"
Anti-icing AI OFF		All reversers inoperative		Isa temp 15 C TODA 3000 M			CONF 3	
Dry check				rwy slope 0.00% ASDA 3000 M				D20
OAT	TAILWIND	WIND	HEADWIND	HEADWIND	HEADWIND	HEADWIND		
C	-10 KT	0 KT	5 KT	10 KT	10 KT	20 KT		
10	158.3 3/3 122/23/35	233.3 3/9 123/42/48	235.9 3/9 125/43/49	238.3 3/9 127/44/50	240.3 2/3 131/47/52			
20	227.9 3/9 121/40/46	232.1 3/9 123/42/48	234.8 3/9 125/43/48	238.4 3/9 129/45/50			

Figure C34: Derated RTOW Chart on a Runway Covered with Standing Water

7.2.4. Derated Takeoff Procedure

Derated takeoff is **not available for all Airbus aircraft models**. It is basic on all A330 and A340 models¹, but doesn't yet exist on the other Airbus aircraft types².

When derated takeoff is available, 6 certified levels exist, ranging from (TOGA-4%) to (TOGA-24%) with a constant four percent increment (4%, 8%, 12%, 16%, 20% and 24%)³. This means that the AFM must contain a set of performance data for TOGA, and a set for each derate level (TOGA - X%).

To carry out a derated takeoff, the actual takeoff weight and speeds have to be checked against the Maximum permissible takeoff weight computed for the given derate level (specific RTOW chart or equivalent computerized system). The derate level must then be entered in the MCDU (Multipurpose Control and Display Unit) during the takeoff preparation phase (Figure C35). At the brake release point, the thrust throttles must be pushed to the FLX position (Figure C36).

Important: When a derated takeoff is carried out, **TOGA thrust must never be selected** until the aircraft is airborne and above the minimum flap retraction speed ("F" speed). The reason for this is that performance calculations are made for minimum control speeds, different from the ones of TOGA.

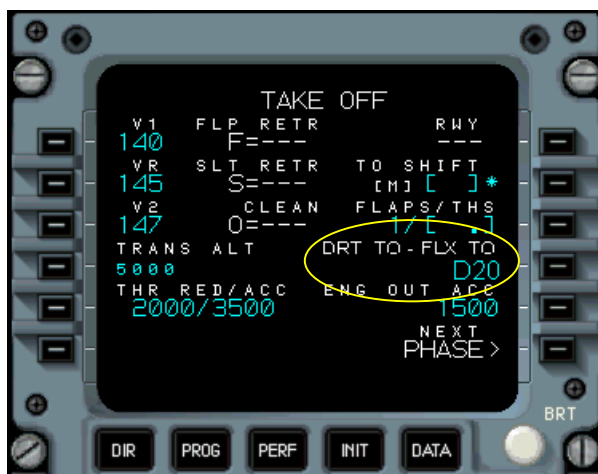

Figure C35: MCDU Takeoff Performance Page

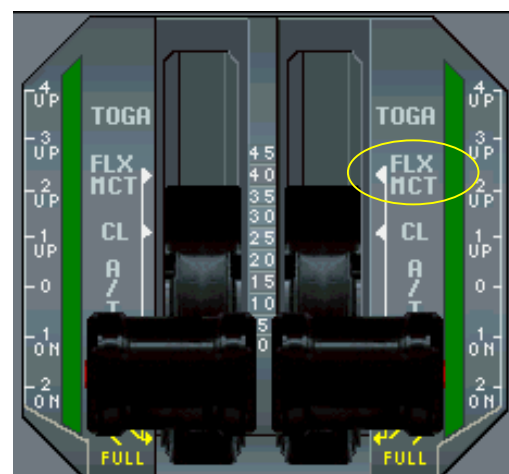

Figure C36: Thrust Throttle Positions

Note that in the Airbus philosophy, **a flexible takeoff can not be cumulated with a derated takeoff**.

¹ Standard after 1998, option before 1998

² Option soon available on A320 family

³ For A340-500/-600, two supplementary derate levels: 32% and 40%

D. EN ROUTE LIMITATIONS

1. EN ROUTE FAILURE CASES

In flight, engine or pressurization failures are potential problems, which must be carefully studied before operating a new route. Their occurrence seriously impact on flight altitudes and, therefore, become very constraining over mountainous areas.

In case of an **engine failure** during flight, the remaining thrust is no longer sufficient to balance the drag force and to maintain an adequate cruise speed. The thrust necessary to fly at the initial altitude suddenly becomes greater than the available thrust delivered by the engines pushed at their Maximum Continuous Thrust (MCT) rating. The only solution is to then descend to a more appropriate flight altitude, where the available thrust can equal the required thrust, thus allowing the aircraft **to level off**.

In case of an in-flight cabin **pressurization loss**, descent is also necessary. It is not dictated by a performance constraint, but by the oxygen system constraint. Indeed, at the initial cruise altitude, the rate of oxygen in the air is insufficient to allow crewmembers and passengers to breathe normally. This is why the installation of an oxygen system is required. As the necessary oxygen quantity must be quite significant to supply the entire cabin, its flow rate is limited to a **maximum duration**. So, a new flight altitude, where oxygen is no longer required must be reached, before a certain time limit.

The descent cannot be always operated in the same conditions, since, aircraft are sometimes over-flying mountainous areas. This is why, in these particular cases, a route study is necessary to evaluate whether or not an acceptable escape procedure is possible when a failure occurs at the worst moment during flight. If it is possible, it must be clearly defined and indicated to the pilots. If it is not possible, a new route must be found.

Any route study must be done in accordance with airworthiness requirements, detailed in the following sections.

2. ENGINE FAILURE(S)

2.1. General Definitions

2.1.1. Drift Down procedure

In case of an engine failure over a mountainous area during the climb or cruise phase, the Obstacle Strategy or Drift Down Strategy (Figure D1) should be applied. This procedure consists in:

- Selecting Maximum Continuous Thrust (MCT) on the remaining engine(s).
- Decelerating to green dot speed.

- Climbing or descending at green dot speed until reaching the drift down ceiling¹.

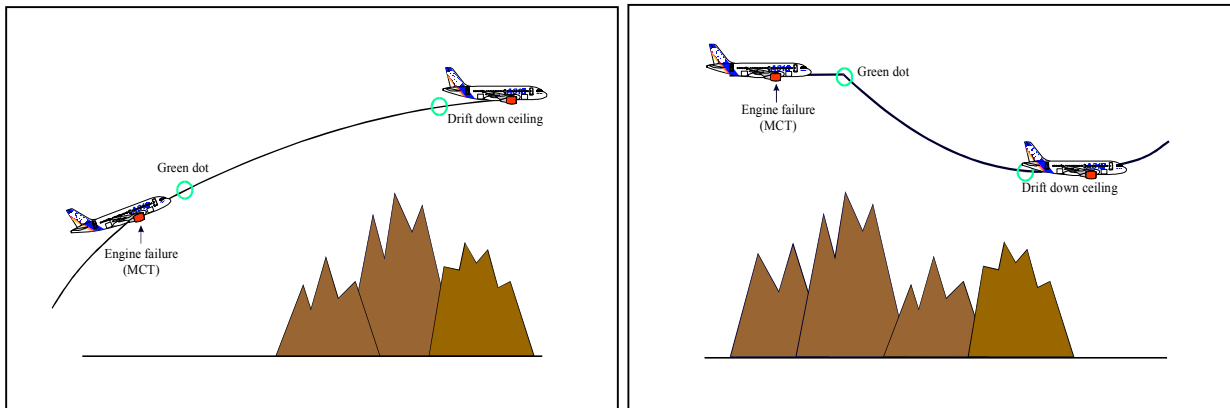

Figure D1: Drift Down Procedure (Climb and Descent)

Green dot speed, indicated by a green circle on the primary flight display (PFD), represents the best lift-to-drag ratio speed, where aerodynamic efficiency is maximum. As a consequence, the drift down strategy is the procedure enabling the highest possible altitude to be achieved versus the distance covered.

2.1.2. Gross and Net Drift Down Flight Paths

JAR 25.123 Subpart B

FAR 25.123 Subpart B

2.1.2.1. Gross Drift Down Flight Paths

The **Gross Drift Down Flight Path** is the flight path actually flown by the aircraft after engine failure (Figure D2). Regulations require that operators be provided the with drift down performance information, as stated below:

“JAR/FAR 25.123

(a) For the en-route configuration, the [gross drift down] flight path must be determined at each weight, altitude, and ambient temperature [...]. The variations of the weight along the flight path, accounting for the progressive consumption of fuel [...] by the operating engines, may be included in the computation. The flight paths must be determined at any selected speed, with:

- The most unfavourable centre of gravity
- The critical engine inoperative”

2.1.2.2. Net Drift Down Flight Path

The **Net Drift Down Flight Path** represents the Gross flight path minus a mandatory reduction (Figure D2).

¹ Drift down ceiling = maximum altitude that can be flown at green dot speed (level off)

“JAR/FAR 25.123

(b) The one-engine-inoperative net flight path data must represent the actual climb performance diminished by a gradient of climb of

- 1.1% for two-engined aeroplanes
- 1.6% for four-engined aeroplanes.”

(c) The two-engine-inoperative net flight path must represent the actual climb performance diminished by a gradient of climb of

- 0.5% for four-engined aeroplanes.”

Net Gradient = Gross Gradient – Gradient Penalty

	Gradient penalty	
	Two-engine aircraft	Four-engine aircraft
Net flight path (one engine out)	1.1%	1.6%
Net flight path (two engines out)	-	0.5%

Table D1: Gradient Penalties Between Gross and Net Drift Down Flight Paths

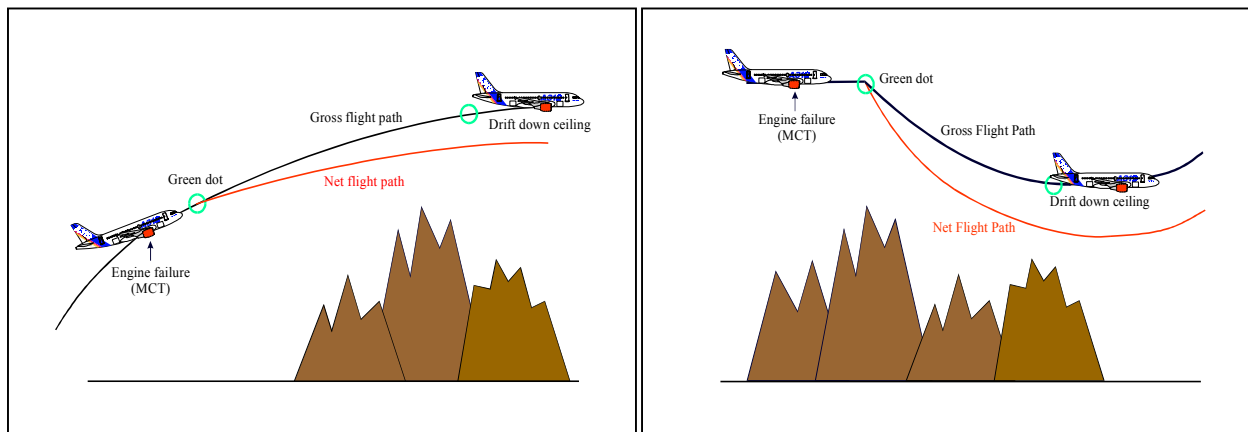

Figure D2: Gross and Net Drift Down Flight Paths (Climb and Descent)

2.1.3. Takeoff Alternate Airport

JAR-OPS 1.295 Subpart D

FAR 121.617 Subpart U

If an engine failure occurs during the takeoff phase, the preferred option is generally to turn back and land at the departure airport. When the landing requirements are not met, for meteorological or performance reasons, it is necessary to plan a takeoff alternate airport, which shall be located within:

- **One hour** flight time at a one-engine-inoperative cruising speed in still air for **twin engine aircraft**.
- **Two hour** flight time at a one-engine-inoperative cruising speed in still air for **four engine aircraft**.

When it is not possible to return, the flight must be pursued to the takeoff alternate airport, and the en route configuration¹ achieved after a maximum of 10 minutes from the brake release point. As a result, the **drift down climb phase starts at the end of the takeoff flight path**. To reach the takeoff alternate airport, the obstacle clearance must be ensured, in accordance with the following paragraph:

2.2. En route Obstacle Clearance – One Engine Inoperative

2.2.1. Lateral Clearance

Obstacle clearance must be ensured throughout the route, in case of an engine failure. The problem is to clearly identify which obstacles must be cleared. Regulations indicate which obstacles must be taken into account:

JAR-OPS 1.500 Subpart G

FAR 121.191 Subpart I

“JAR-OPS 1.500

(c) The net flight path must permit the aeroplane to continue flight from the cruising altitude to an aerodrome where landing can be made [...] clearing [...] all terrain and obstructions along the route within 9.3 km (5 nm) on either side of the intended track”

(d) [...] an operator must increase the widths margins [...] to 18.5 km (10 nm) if the navigational accuracy does not meet the 95% containment level².” (Figure D3).

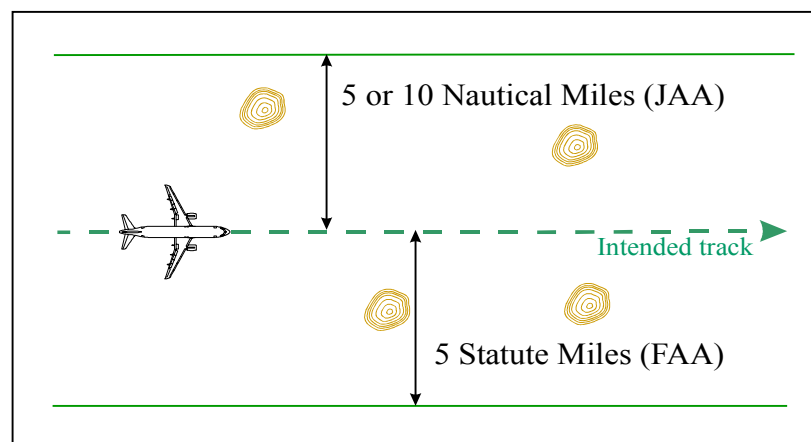

Figure D3: Lateral Clearance

Note that the **FAR** regulation is quite similar, except that it requires a lateral margin of **5 statute miles** on each side of the intended track. Moreover, it stipulates that a “different procedure” approval is needed, when the aircraft is further from the nearest approved radio navigation fix than from the critical obstruction it has to pass over.

To carry out a detailed route study (engine failure case), a topographic map shall be used and the highest obstacles inside the required corridor width determined.

Another, less time consuming, but less accurate method, consists of using the

¹ En route configuration = clean configuration, green dot speed, Maximum Continuous Thrust

² The 95% containment level is generally achieved if the aircraft navigational system has been updated within two hours, or if the aircraft is equipped with GPS primary.

published Minimum Flight Altitudes which already account for a margin of 2,000 feet on the obstacles (refer to the “Minimum flight altitude” section of this chapter).

2.2.2. Vertical Clearance

Vertical clearance shall always be understood as a **margin between the net flight path and the obstructions**. The en route net flight path shall be determined from the **Aircraft Flight Manual**, and must take into account the meteorological conditions (**wind and temperature**) prevailing in the area of operations. Moreover, if icing conditions can be expected at the diversion level, the effect of the **anti-ice** system must be considered on the net flight path.

JAR-OPS 1.500 Subpart G

FAR 121.191 Subpart I

Any route study should be conducted by checking one of the following two vertical clearance conditions. When Condition 1 cannot be met, or when it appears to be too penalizing in terms of weight, a detailed study must then be carried out based on Condition 2.

2.2.2.1. Condition 1 : 1,000 feet clearance margin

“JAR-OPS 1.500

(b) *The gradient of the net flight path must be positive at at least 1,000 ft above all terrain and obstructions along the route.*” (Figure D4)

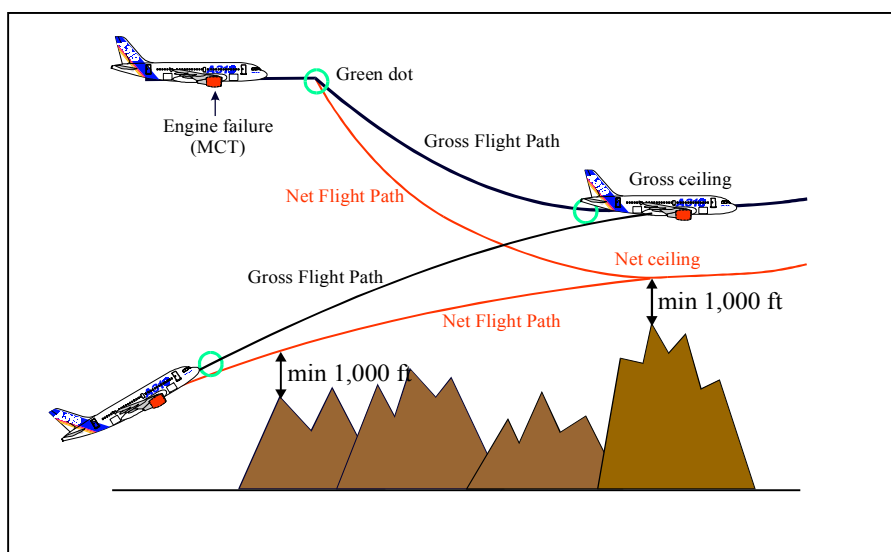

Figure D4: Vertical Clearance (1,000 feet)

A- Methodology, in case of an Engine Failure in Climb

- Determine the location of the start of the en route flight path in the worst conditions.
- From a topographic map select, in the regulatory corridor, all the constraining obstacles that must be cleared during the climb phase. Plot these obstacles on a graph, with their distance from the start of the en route flight path (horizontal axis) and their height (vertical axis).

- From the AFM, determine the climb net flight path for a conservative weight (for instance, use the maximum certified takeoff weight), and for conservative meteorological conditions. Plot it on the previous graph.
- Conclusion:
 - If the net flight path clears each obstacle with a margin of at least 1,000 feet, the route study is finished and obstacle clearance is ensured at any moment during climb.
 - If the net flight path doesn't clear at least one of the obstacles by 1,000 feet, reduce the takeoff weight and recalculate the net flight path until the previous condition is checked. If it is not possible, establish a new diversion procedure¹.

B- Methodology in case of an Engine Failure at Cruise Level

- From a topographic map, determine the highest obstacle in the regulatory corridor and add 1,000 feet to obtain a height H_1 .
- From the AFM, determine the net drift down ceiling (H_2) at a conservative weight. For instance, choose the heaviest possible aircraft weight at the entrance of the constraining area.
- Conclusion:
 - If H_2 is higher than H_1 , the route study is completed and the obstacle clearance is ensured at any moment.
 - If H_2 is lower than H_1 , then a more detailed study based on Condition 2 shall be conducted, or a weight limitation at takeoff established, or a new route found.

2.2.2.2. Condition 2 : 2,000 feet clearance margin

Condition 2 concerns the case of an engine failure during the cruise phase. When Condition 1 is not met, or when it is too limiting in terms of weight, a drift down procedure should be worked out, as detailed below:

JAR-OPS 1.500 Subpart G

FAR 121.191 Subpart I

“JAR-OPS 1.500

(c) *The net flight path must permit the aeroplane to continue flight from cruising altitude to an aerodrome where a landing can be made, [...] clearing vertically, by at least 2,000 ft all terrain and obstructions along the route within [the prescribed corridor].*” (Figure D5).

At any point of a critical area on the route, it must always be possible to escape while ensuring, during descent, the relevant obstacle clearance margin of 2,000 feet on the net flight path. The following three escape procedures are available: **Turn back**, **Divert**, or **Continue**.

¹ This study mainly concerns the case of a diversion to a takeoff alternate airport

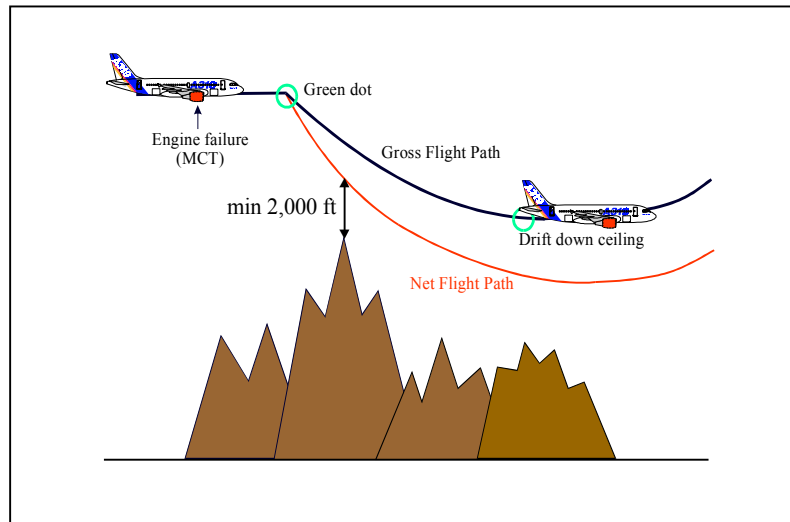

Figure D5: Vertical Clearance (2,000 feet)

Methodology in case of an Engine Failure at Cruise Level

- Identify the **critical points** on the route: A critical point is a point at which, if an engine failure occurs and if the aircraft initiates a drift down, the net flight path clears the most penalizing obstacle by the minimum margin of 2,000 feet. The aircraft weight at each critical point is assumed to be the highest possible weight that can be expected at that point in the most penalizing meteorological conditions. A critical point can be :
 - **A no-return point (A)**: Point after which it is not possible to turn back, otherwise the 2,000 feet obstacle clearance margin on the net flight path would not be met.
 - **A continuing point (B)**: Point after which it is possible to continue on the route because the 2,000 feet obstacle clearance margin on the net flight path is ensured.
- Select, in the regulatory corridor, all the constraining obstacles that must be cleared during the drift down and plot these obstacles on a graph, with the distance as the horizontal axis and the height as the vertical axis.
- From the AFM, determine the returning net flight path¹ and the continuing net flight path, taking into account the most adverse wind conditions. For that purpose, use a conservative initial weight (for instance, choose the heaviest possible aircraft weight at the entrance of the constraining area). Plot the net paths on the previous graph so that the most penalizing obstacles are just cleared with the minimum margin of 2,000 feet.
- Conclusion:
 - If the **no-return point (A)** is obtained **after** the **continuing point (B)** (Figure D6), the procedure should be as follows, unless another procedure is found to be more appropriate (closer diversion airport, safer escape procedure...). If the engine failure occurs:
 - ✓ Before B: Return
 - ✓ After A: Continue
 - ✓ Between A and B: Either return or continue

¹ The returning net flight path takes into account the altitude and time lost for turn back.

- If the **no-return point (A)** is obtained **before** the **continuing point (B)** (Figure D7), the procedure should be as follows, unless another procedure is found to be more appropriate. If the engine failure occurs:
 - ✓ Before A: Return
 - ✓ After B: Continue
 - ✓ Between A and B: Establish an escape procedure, ensuring the relevant obstacle clearance margin. If it is not possible, consider a weight reduction at takeoff. If the weight reduction is too penalizing, consider another route.

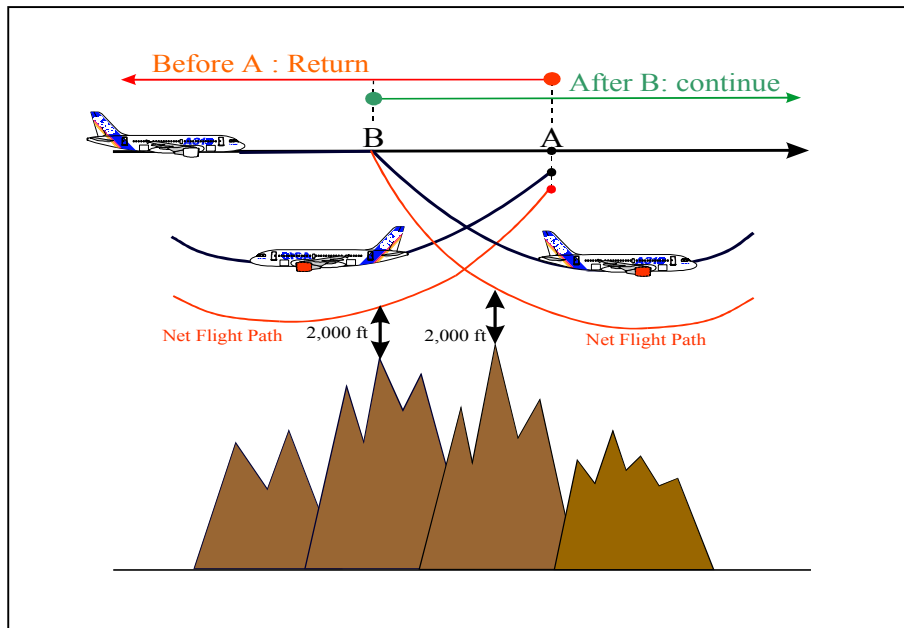

Figure D6: Continuing Point (B) Located Before the No-Return Point (A)

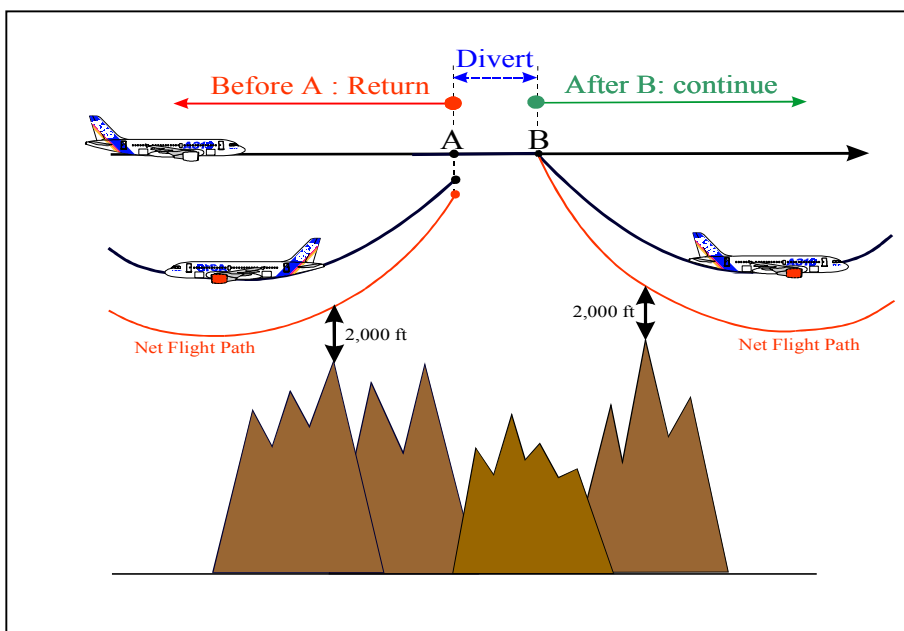

Figure D7: Continuing Point (B) Located After the No-Return Point (A)

2.2.3. Diversion Airfield

JAR-OPS 1.500 Subpart G

FAR 121.191 Subpart I

“JAR-OPS 1.500

(a) *The net flight path must have a positive gradient at 1,500 ft above the aerodrome where the landing is assumed to be made after an engine failure.*” (Figure D8)

The route study must indicate the different possible en route diversion airfields associated with the various diversion scenarios. The net flight path gradient should be positive at least at 1,500 feet above the airport where the landing is assumed to be made. For that purpose, fuel jettisoning can be considered, when the system is available.

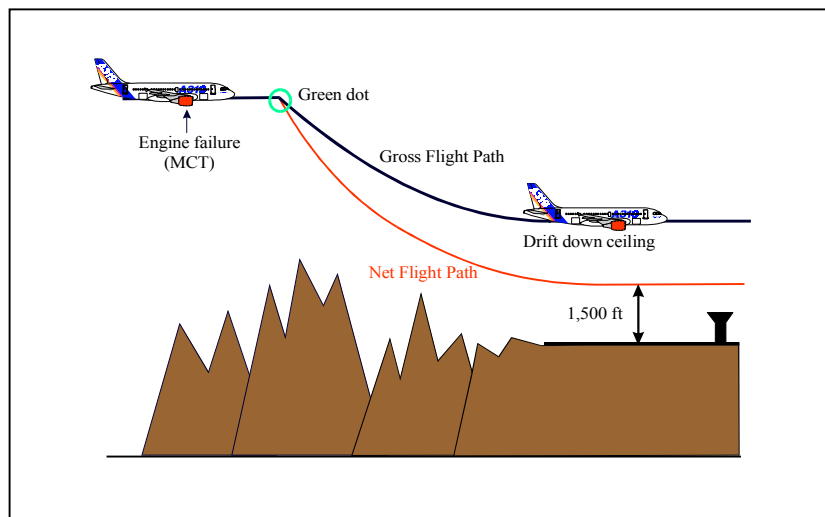

Figure D8: Performance Requirement Above Diversion Airport

Moreover:

“JAR-OPS 1.500

(c)(4) *The aerodrome where the aeroplane is assumed to land after engine failure must meet the following criteria:*

- *The performance requirements at the expected landing mass are met*
- *Weather reports or forecasts, or any combination thereof, and field condition reports indicate that a safe landing can be accomplished at the estimated time of landing”*

Alternate airports must be clearly specified in the dispatch or flight release, and must meet the prescribed **weather minimums for the approach category**. If these minimums are not met, the associated diversion procedures are no longer possible.

2.3. Twin Engine Aircraft

2.3.1. 60 Minute Rule

JAR-OPS 1.245 Subpart D
 JAR-OPS 1.246 Subpart D
 JAA Information Leaflet 20

FAR 121.161 Subpart H
 AC 120-42A

“JAR-OPS 1.245

(a) Unless specifically approved by the Authority [...], an operator shall not operate a two-engined aeroplane over a route which contains a point further from an adequate aerodrome than the distance flown in 60 minutes at the [approved] one-engine-inoperative cruise speed”.

When at least one route sector is at more than 60 minutes' flying time, with one engine inoperative from a possible en route diversion airfield (Figure D9), the airline needs specific approval, referred to as ETOPS¹ approval. ETOPS is dealt with in an Airbus-specific brochure entitled: “**Getting to Grips with ETOPS**” and will, therefore, not be detailed in this manual.

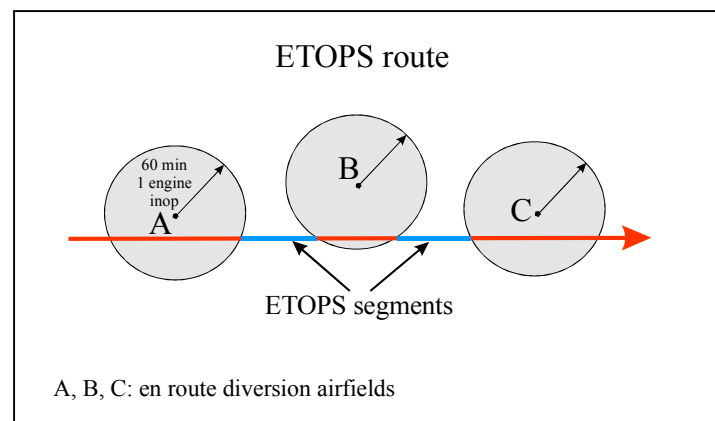

Figure D9: 60 Minute Rule

2.4. Four Engine Aircraft

2.4.1. 90 Minute Rule

JAR-OPS 1.505 Subpart G

FAR 121.193 Subpart I

“JAR-OPS 1.505

(a) An operator shall ensure that at no point along the intended track will an aeroplane having three or more engines be more than 90 minutes, at the all-engines long range cruising speed at standard temperature in still air, away from an aerodrome at which [landing] performance requirements are met, unless it complies with [specific rules]”.

¹ ETOPS = Extended range with Twin-engine aircraft OPerationS

These specific rules, developed later, assume the **simultaneous failure of two engines**, which has to be considered for dispatch, as soon as one route sector is at more than 90 minutes' flying time, with all engines, from a possible en route diversion airfield.

“JAR-OPS 1.505

(c) *The two engines are assumed to fail at the most critical point of that portion of the route where the aeroplane is more than 90 minutes [flying time] away from [a possible diversion] aerodrome.*” (Figure D10).

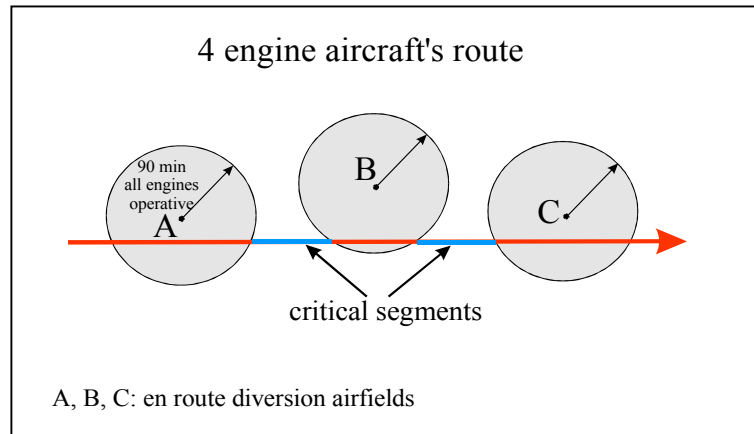

Figure D10: 90 Minute Rule

2.4.2. Obstacle Clearance – Two Engines Inoperative

2.4.2.1. Lateral Clearance

The regulations define the corridor width within which obstacles must be taken into account, as follows:

JAR-OPS 1.505 Subpart G

FAR 121.193 Subpart I

“JAR-OPS 1.505

(b) *The two engines inoperative en-route net flight path data must permit the aeroplane to continue the flight, in the expected meteorological conditions, from the point where two engines are assumed to fail simultaneously, to an aerodrome at which it is possible to land, [...] clearing all terrain and obstructions along the route within 9.3 km (5 nm)¹ on either side of the intended track. [...] If the navigational accuracy does not meet the 95% containment level, an operator must increase the width margin [...] to 18.5 km (10 nm)².*”

¹ FAA: 5 statute miles

² JAA rule not valid for FAA

2.4.2.2. Vertical Clearance

Vertical clearance shall always be understood as a **margin between the two engines' inoperative net flight path and the obstructions**. The two engines inoperative en route net flight path shall be determined from the **Aircraft Flight Manual**, and must take into account the meteorological conditions (wind and temperature) prevailing in the area of operations, as well as the use of ice protection systems, if required.

JAR-OPS 1.505 Subpart G

FAR 121.193 Subpart I

“JAR-OPS 1.505

The net flight path must clear vertically, by at least 2,000 ft all terrain and obstructions along the route within [the prescribed corridor].”

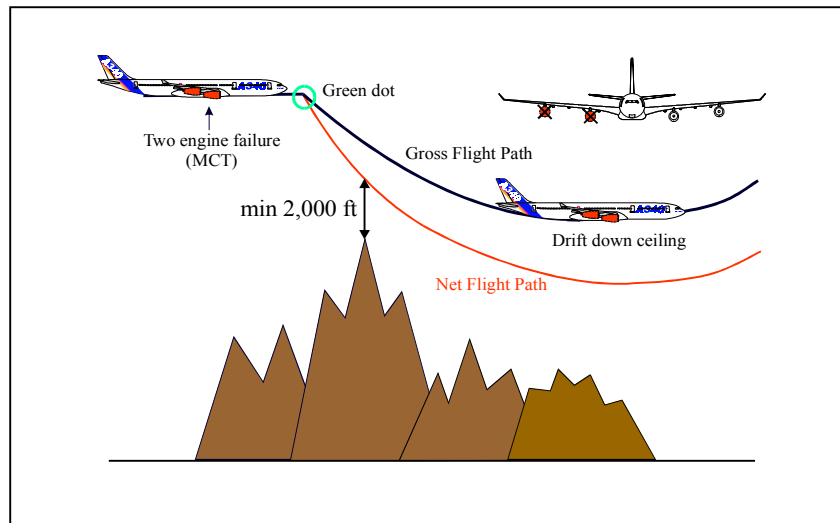

Figure D11: Obstacle Clearance 2,000 feet – Two Engines Inoperative

2.4.3. Diversion Airfield – Two Engines Inoperative

JAR-OPS 1.505 Subpart G

FAR 121.193 Subpart I

“JAR-OPS 1.505

(d) The net flight path must have a positive gradient at 1,500 ft above the aerodrome where the landing is assumed to be made after the failure of two engines.” (Figure D12).

The route study must indicate the different possible en route diversion airfields, associated with the various diversion scenarios. The two-engine inoperative net flight path gradient should be positive at least at 1,500 feet above the airport where the landing is assumed to be made. For that purpose, fuel jettisoning can be considered, when the system is available.

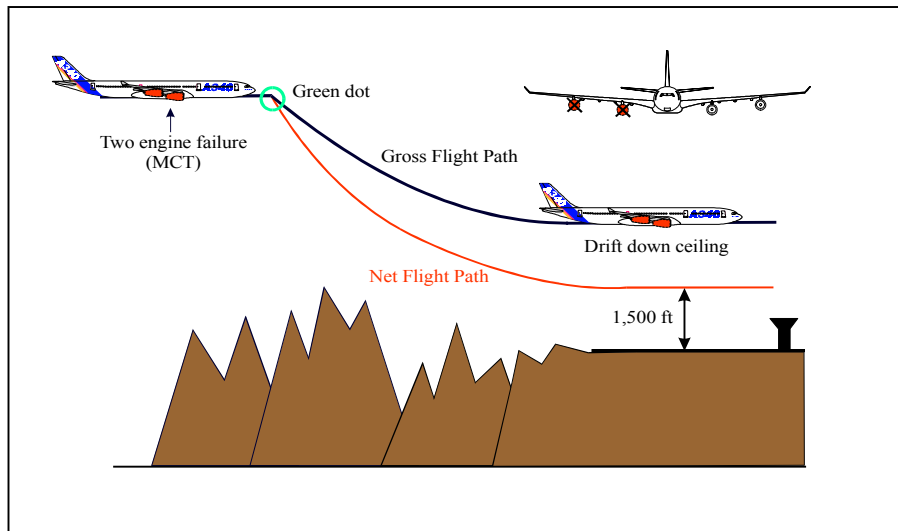

Figure D12: Performance Requirement above Diversion Airport

3. IN-FLIGHT CABIN PRESSURIZATION FAILURE

JAR-OPS 1.770 + Appendix 1
JAR-OPS 1.760

FAR 121.329
FAR 121.333

3.1.1. Oxygen Systems

“JAR-OPS 1.770

(a)(1) *An operator shall not operate a pressurized aeroplane at pressure altitudes above 10,000 ft unless supplemental oxygen equipment [...] is provided.*”

After a cabin pressurization failure, oxygen is automatically supplied to passengers through individual dispensing units, immediately available to each occupant. These units are automatically deployed in case of a cabin pressurization loss, but **they only supply oxygen for a limited period of time.**

The duration of passenger oxygen supply varies, depending on the system. As of today¹, two main oxygen system categories exist: **Chemical systems** and **gaseous systems**.

3.1.1.1. Chemical systems

A chemical system has the following characteristics:

- There is an independent chemical generator, which is fired when the mask is pulled. Afterwards, **it's not possible to stop the oxygen flow.**
- The oxygen flow and supply pressure are **independent** of the cabin altitude.

¹ A new oxygen system called OBOGS (On Board Oxygen Generation System) is under development. This system will provide oxygen continuously.

- The oxygen is supplied to passengers for a specific period of time, which can either be **15 or 22 minutes**.
- A **maximum flight profile is predetermined** for such a system

3.1.1.2. Gaseous Systems

A gaseous system has certain advantages, over the chemical system:

- It is **customizable** by selecting the number of high pressure oxygen bottles (up to 14 cylinders on the A340).
- The oxygen flow and supply pressure **depend** on the altitude. The flow rate is controlled by an altimetric flow regulation device in each mask container. It enables passenger oxygen consumption to be optimized: The lower the altitude, the lower the oxygen flow.
- **The oxygen supply time depends on the flight profile, and on the number of cylinders installed.**
- There is no oxygen flow below a cabin pressure altitude of 10,000 feet.

3.1.2. Passenger Oxygen Requirement

To help operators determine their needs in terms of supplementary oxygen, regulations provide the minimum required oxygen quantity versus the flight altitude. This information is given for flight crewmembers, cabin crewmembers, as well as for passengers. Nevertheless, oxygen reserves for crewmembers are always much more significant than for passengers and, consequently, the descent profile is always more limited by the passenger oxygen system than by the crew oxygen systems.

JAR-OPS 1.770 + Appendix 1
JAR-OPS 1.760

FAR 121.329
FAR 121.333

“FAR 121.329

(c)(1) For flights at cabin pressure altitudes above 10,000 feet, up to and including 14,000 feet, there must be enough oxygen for that part of the flight at those altitudes that is of more than 30 minutes duration, for 10% of the passengers.

(c)(2) For flights at cabin pressure altitudes above 14,000 feet, up to and including 15,000 feet, enough oxygen for that part of the flight at those altitudes for 30 % of the passengers.

(c)(3) For flights at cabin pressure altitudes above 15,000 feet, enough oxygen for each passenger carried during the entire flight at those altitudes.”

“FAR 121.333

(e)(2) [...] there must be not less than a 10 minute supply for the passenger cabin occupants.”

(e)(3) [...] For first-aid treatment of occupants [...], a supply of oxygen must be provided for two percent of the occupants for the entire flight after cabin depressurization at cabin altitudes above 8,000 ft, but in no case to less than one person.”

The last condition is generally achieved by portable oxygen. As a result, the following table (D2) summarizes the passenger oxygen requirement :

Flight Altitude	> 15,000 ft	Supply to 100% of passengers
	> 14,000 ft ≤ 15,000 ft	Supply to 30% of passengers
	> 10,000 ft ≤ 14,000 ft	Supply to 10% of passengers (not required during the first 30 minutes)
	> 8,000 ft ≤ 10,000 ft	Supply to 2% of passengers after cabin depressurization (achieved by portable oxygen).
With a minimum of 10 minute supply for 100% of passengers		

Table D2: Passenger Oxygen Supply Requirement

3.1.3. Flight Profile

3.1.3.1. Oxygen system limitation

Following a cabin pressurization failure, the **cabin pressure altitude shall be considered the same as the aircraft’s pressure altitude**, unless it can be demonstrated that it is highly unlikely. In the studies, it is always assumed that the cabin pressure altitude is the same as the aircraft’s pressure altitude.

As a result, it is possible to establish a **flight profile**, with which the aircraft must always remain, taking into account the above-mentioned oxygen requirements. This profile depends on the installed oxygen system:

- **Chemical system: Fixed profile** (published in the FCOM).
- **Gaseous system: Customized profile** (depends on the number of oxygen bottles and obstacle location).

This flight profile represents the maximum level that can be flown with respect to the oxygen system’s capability. As an example, the following Figure (D13) shows the descent profile of a 22 minute oxygen system.

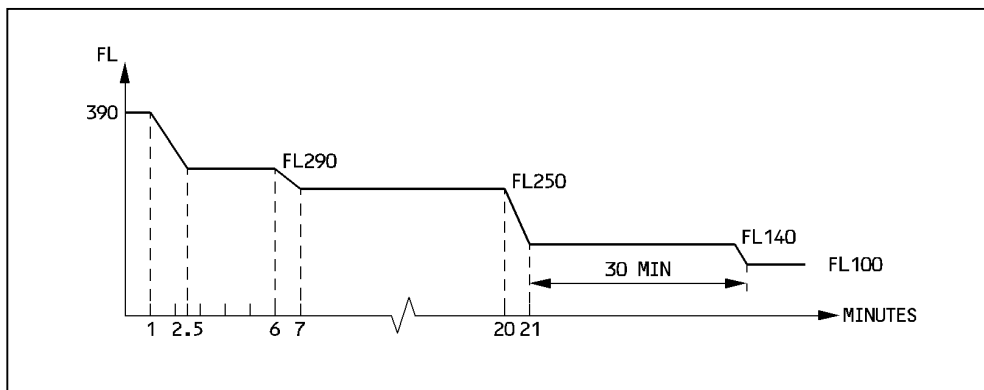

Figure D13: A319 Descent Profile - 22 Minute Oxygen System

For example, the above profile shows that 7 minutes after the cabin depressurization, the aircraft must fly at or below FL250.

3.1.3.2. Performance limitation

The above descent profile only depends on the oxygen system’s capability, and not on the aircraft’s performance capability.

Nevertheless, this doesn’t mean that the aircraft is always able to follow the oxygen profile, particularly in descent. As a consequence, the performance profile must be established, and this profile must always remain below the oxygen profile. The calculation is based on the following assumptions:

- Descent phase: Emergency descent at MMO/VMO. Airbrakes can be extended to increase the rate of descent, if necessary.
- Cruise phase: Cruise at maximum speed (limited to VMO).

As a result, for a given initial weight and flight level, the oxygen profile, function of the time, is transformed into a performance profile, function of the distance (Figure D14).

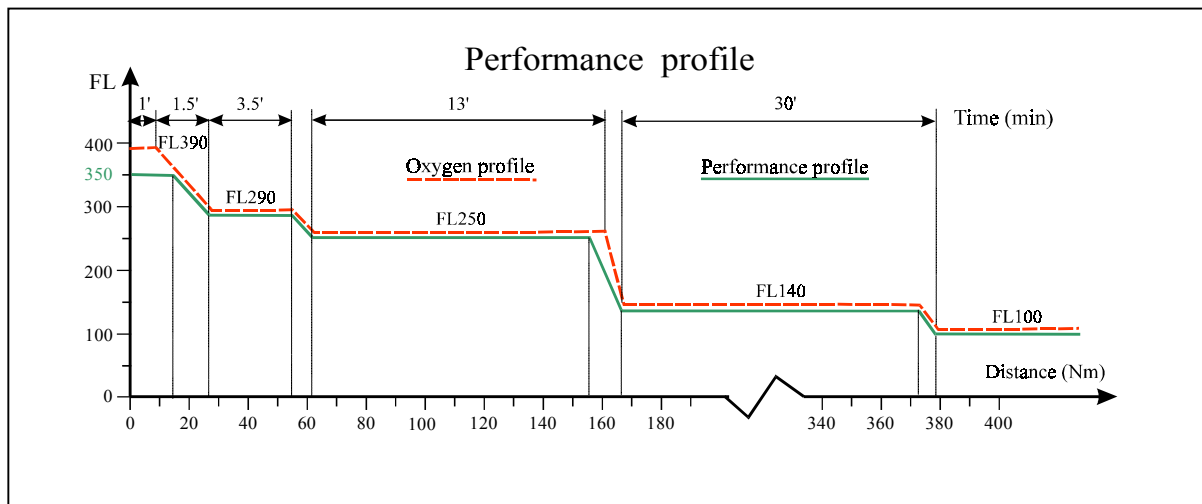

Figure D14: A319 Performance Profile – 22 Minute Oxygen System

Note: When establishing this performance profile, **it is always assumed that the aircraft is able to fly at MMO/VMO**. Cases where speed should be decreased (structural damage, turbulence...) have not to be taken into account.

3.1.4. Minimum Flight Altitudes

JAR-OPS 1.250
IEM OPS 1.250

FAR 121.657

The minimum flight altitudes must be selected as follows:

“FAR 121.657

(c) No person may operate an aircraft under IFR, [...] in designated mountainous areas, at an altitude less than 2,000 ft above the highest obstacle within a horizontal distance of five miles from the center of the intended course.”

“JAR-OPS 1.250

(a) An operator shall establish minimum flight altitudes and the methods to determine those altitudes for all route segments to be flown [...].

(b) Every method for establishing minimum flight altitudes must be approved by the authority.”

To assist JAA operators in their choice, guidance material is provided in IEM OPS 1.250, where the most common definitions of published minimum flight altitudes are recalled:

- **MOCA** (Minimum Obstacle Clearance Altitude) and **MORA** (Minimum Off-Route Altitude). They correspond to the maximum terrain or obstacle elevation, plus:
 - 1,000 feet for elevation up to and including 5,000 feet (or 6,000 feet)¹.
 - 2,000 feet for elevation exceeding 5,000 feet (or 6,000 feet) rounded up to the next 100 feet.
- **MEA** (Minimum safe En route Altitude) and **MGA** (Minimum safe Grid Altitude). They correspond to the maximum terrain or obstacle elevation, plus:
 - 1,500 feet for elevation up to and including 5,000 feet.
 - 2,000 feet for elevation above 5,000 feet and below 10,000 feet.
 - 10% of the elevation plus 1,000 feet above 10,000 feet.

As a result, the **minimum flight altitude** above 10,000 feet considered acceptable to carry out studies, is equal to the **highest obstacle elevation plus 2,000 feet**.

3.1.5. Obstacle Clearance – Cabin Pressurization Failure

A net flight path is not required in the cabin pressurization failure case. The net flight path shall be understood as a safety margin, when there is a risk that the aircraft cannot maintain the expected descent performance (engine failure case).

In case of cabin depressurization, any altitude below the initial flight altitude can be flown without any problem as all engines are running. Therefore, the standard minimum flight altitudes apply and the **descent profile must, therefore, clear any obstacle by 2,000 feet** (Figure D15).

¹ Depends on the method: Jeppesen (5,000 feet) or KSS (6,000 feet)

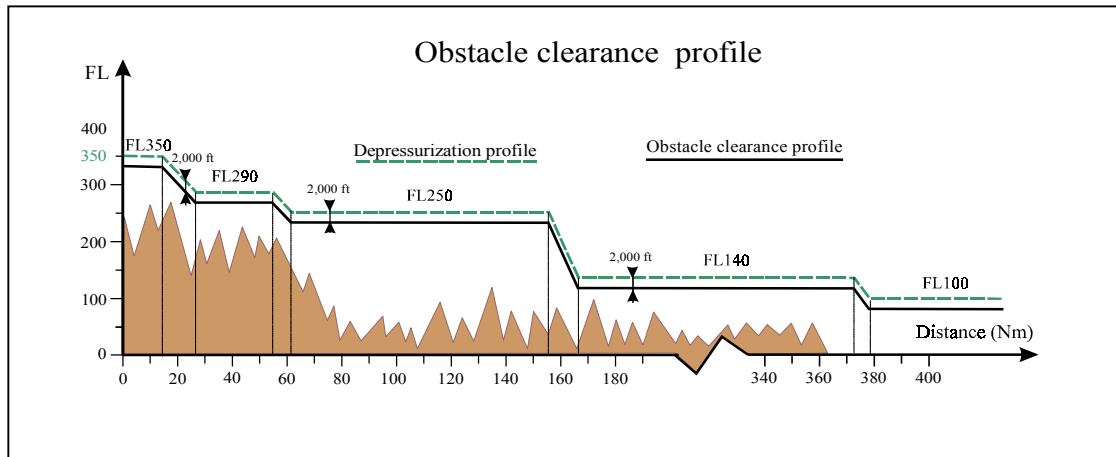

Figure D15: A319 Obstacle Clearance Profile – Pressurization Failure

4. ROUTE STUDY

As a general rule, failures (engine or pressurization) must always be expected to occur at the most critical points of the intended route. Nevertheless, as descent profiles differ, the critical points may differ between the two failure cases. It is important to notice that **regulations don't require to consider performance to cope with both failures simultaneously.**

When both failure cases are dealt with separately, the number of critical points and the specific escape routes also increase. As a result, the complexity may engender a supplementary workload for flight crews and a subsequent risk of error.

This is why, whenever it is possible, it must be preferred to define the same critical points and the same escape routes, whatever the failure case. Thus, the reaction time and the risk of mistake are reduced. In such a case, the route study should be based on the most penalizing descent profile (Figure D16).

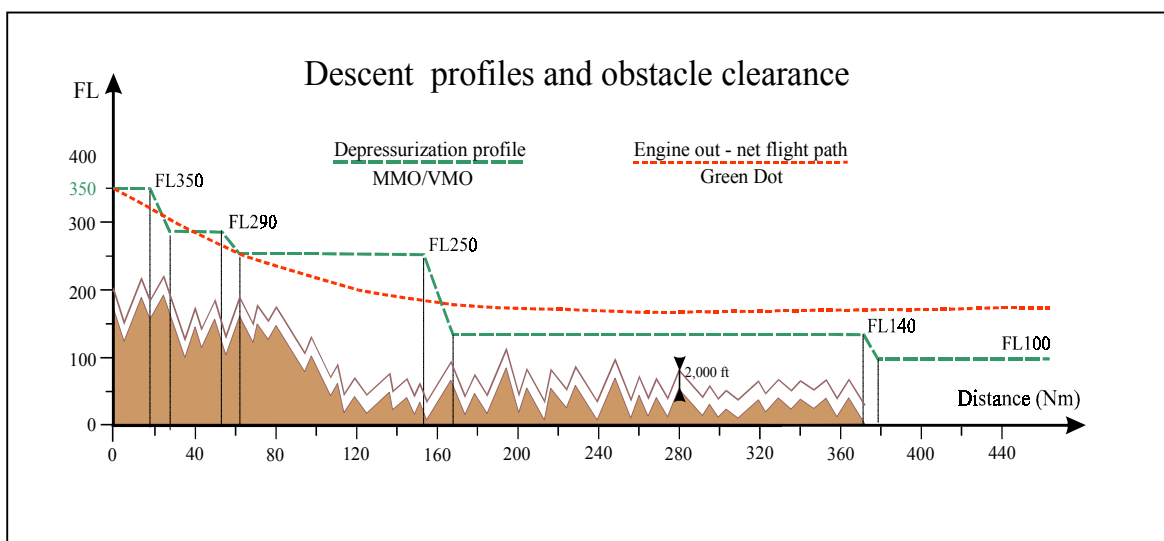

Figure D16: A319 Descent Profiles - Engine + Cabin Pressurization Failures

E. LANDING

1. INTRODUCTION

To dispatch an aircraft, an operator has to verify landing requirements based on airplane certification (JAR 25 / FAR 25) and on operational constraints defined in JAR-OPS and FAR 121. In normal operations, these limitations are not very constraining and, most of the time authorize dispatch at the maximum structural landing weight. This leads to a minimization of the importance of landing checks during dispatch. However, landing performance can be drastically penalized in case of inoperative items, adverse external conditions, or contaminated runways. Flight preparation is, therefore, of utmost importance, to ensure a safe flight.

In the next chapters, we will specify landing requirements based on airworthiness rules, and dispatch conditions. A final chapter will address the flight management and the choice of a diversion landing airport.

2. LANDING DISTANCE AVAILABLE (LDA)

2.1. With no Obstacle under Landing Path

In this case, the Landing Distance Available (LDA) is the runway length (TORA). The stopway cannot be used for landing calculation.

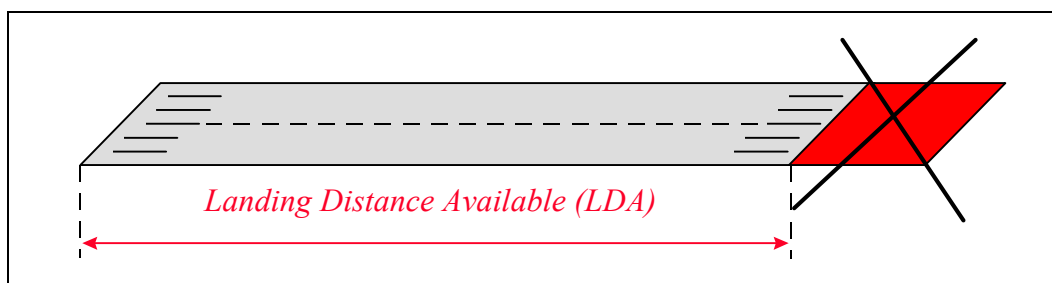

Figure E1: Landing Distance Available

2.2. With Obstacles under Landing Path

The landing distance available (LDA) may be shortened, due to the presence of obstacles under the landing path.

Annex 8 of ICAO recommendations specifies the dimension of the protection surfaces for landing and approach (*Approach funnel*).

When there is no obstacle within the approach funnel, as defined below (see Figure E2), it is possible to use the runway length to land.

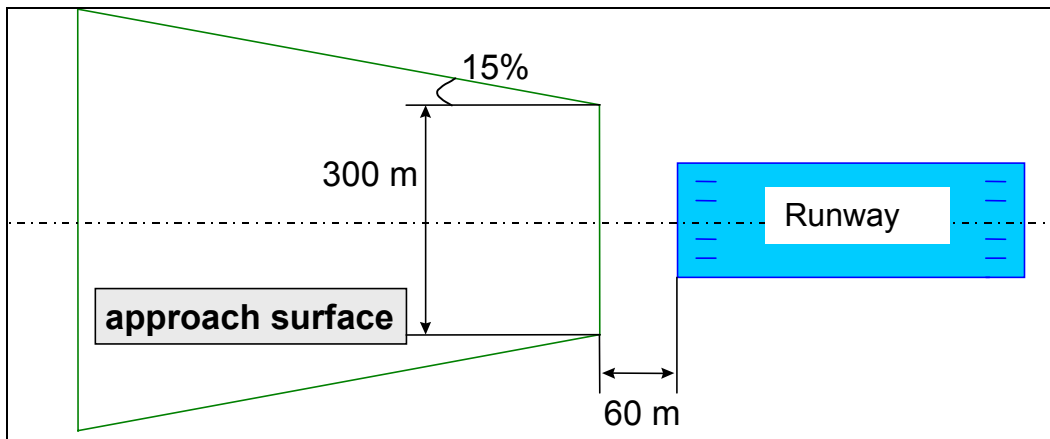

Figure E2 : Approach Surface

However, if there is an obstacle within the approach funnel, a displaced threshold is defined considering a 2% plane tangential to the most penalizing obstacle plus a 60 m margin (Figure E3).

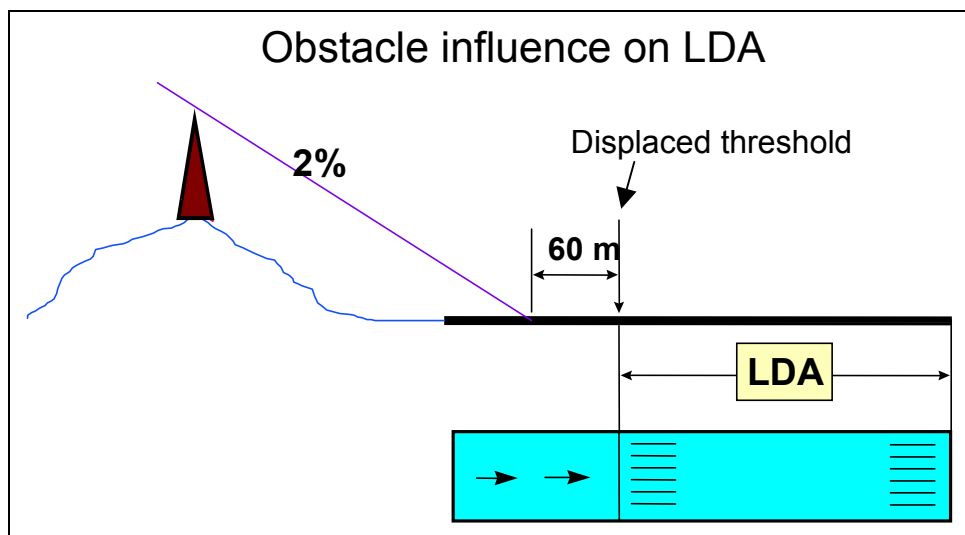

Figure E3: Displaced Threshold

In this case, the Landing Distance Available (LDA) is equal to the length measured from the displaced threshold to the end of the runway.

3. LANDING PERFORMANCE

3.1. Operating Landing Speeds

Originally, the speeds defined in next chapters were manufacturer or operator operating speeds. Today, most of them (as the term V_{REF} the reference landing speed for example) are widely used and understood operationally. The JAR authorities found it convenient to use the same terminology in stating airworthiness requirements and have, indeed, been used in recent requirement amendments.

3.1.1. Lowest Selectable Speed: V_{LS}

As a general rule, during flight phases, pilots should not select a speed below V_{LS} (Lowest Selectable Speed), defined as $1.23 V_{S1g}$ of the actual configuration.

$$V_{LS} = 1.23 V_{S1g}$$

* The 1.23 factor is applicable to the fly-by-wire aircraft (1.3 for the others).

This rule applies for landing. During landing, pilots have to maintain a stabilized approach, with a calibrated airspeed of no less than V_{LS} down to a height of 50 feet above the destination airport.

3.1.2. Final Approach Speed: V_{APP}

V_{APP} is the aircraft speed during landing, 50 feet above the runway surface. The flaps/slats are in landing configuration, and the landing gears are extended.

V_{APP} is limited by V_{LS} :

$$V_{APP} \geq V_{LS}$$

It is very common to retain a margin on V_{LS} to define V_{APP} . For Airbus aircraft, in normal operations, the V_{APP} is defined by:

$$V_{APP} = V_{LS} + \text{wind correction}$$

Wind correction is limited to a minimum of 5¹ knots, and a maximum of 15 knots. V_{APP} is displayed on MCDU APPROach page.

The FMGS and **managed speed** is used to define the $V_{APP \text{ TARGET}}$. It gives efficient speed guidance in approach with windy conditions, since it represents:

$$\begin{aligned} V_{APP \text{ TARGET}} &= \text{GS mini} + \text{actual headwind} \\ \text{GS mini} &= V_{APP} - \text{Tower wind} \end{aligned}$$

Actual headwind is measured by ADIRS, and the tower wind is entered on the MCDU.

¹ When the auto-thrust is used or to compensate for ice accretion on the wings

3.1.3. Reference Speed: V_{REF}

In case of failure in flight, emergency or abnormal configuration, performance computations are based on a reference configuration and on a reference speed. V_{REF} means the steady landing approach speed at the 50 feet point for a defined landing configuration. For Airbus, this configuration is CONF FULL.

That gives:

$$V_{REF} = V_{LS} \text{ in CONF FULL}$$

In case of a system failure affecting landing performance, Airbus operational documentation indicates the correction to be applied to V_{REF} to take into account the failure:

$$V_{APP} = V_{REF} + \Delta V_{INOP}$$

Another speed increment can be added to V_{APP} to account for wind, when needed.

3.2. Actual Landing Distance (ALD)

JAR 25.125 Subpart B

FAR 25.125 Subpart B

3.2.1. Manual Landing

“JAR/FAR 25.125

(a) The horizontal distance necessary to land and to come to a complete stop from a point 50 ft above the landing surface must be determined (for standard temperatures, at each weight, altitude and wind within the operational limits established by the applicant for the aeroplane) as follows:

- *The aeroplane must be in the landing configuration*
- *A stabilized approach, with a calibrated airspeed of V_{LS} must be maintained down to the 50 ft.”*

During airplane certification, the **actual landing distance** is demonstrated as follows:

It is the distance measured between a point **50 feet above the runway threshold, and the point where the aircraft comes to a complete stop.**

To determine this actual landing distance, several conditions must be achieved:

- Standard temperature
- Landing configuration

- Stabilized approach at V_{LS} (or V_{MCL} whichever is greater) for the configuration for manual landing.
- Non excessive vertical acceleration
- Determination on a level, smooth, dry, hard-surfaced runway
- Acceptable pressures on the wheel braking systems
- Braking Means other than wheel brakes: Spoilers, reversers (except on dry runway), can be used when they are safe and reliable.

Actual landing distance is also certified with degraded braking means (spoiler inoperative, one brake inoperative...).

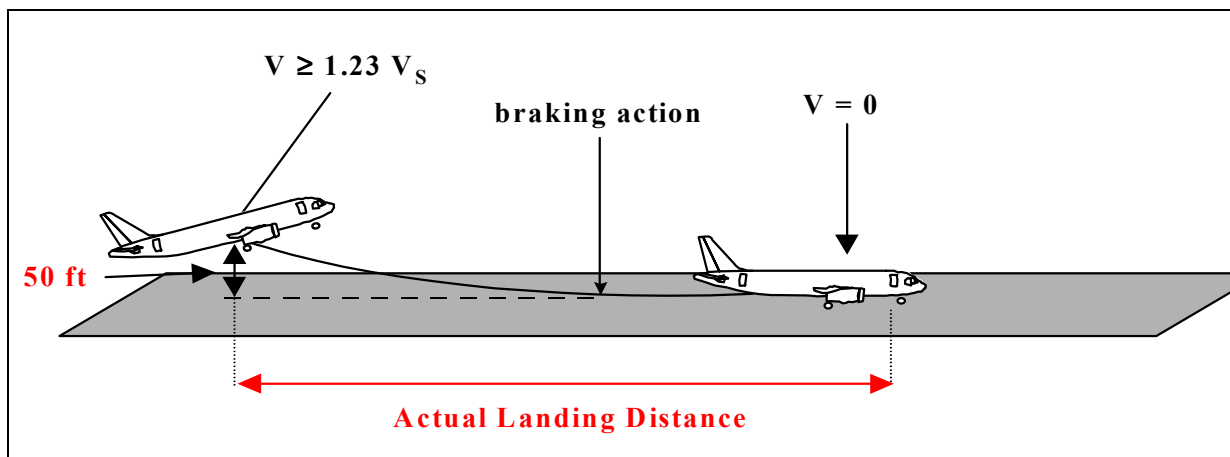

Figure E4: Actual Landing Distance

Actual Landing Distances are **certified on dry runways for all Airbus aircraft, certified on contaminated and icy runways for all fly-by-wire aircraft and published (for information) for wet.**

Demonstrated landing distances will not account for reversers on dry runways. The reverse thrust influence may be considered on contaminated runways.

On dry runways, landing distances are demonstrated with standard temperatures, according to JAR/FAR 25. However, on contaminated runways, Airbus decided to take into account the influence of temperature on landing distance demonstration. This choice ensures added safety as it gives a conservative ALD.

Landing distance data must include correction factors for no more than 50% of the nominal wind components along the landing path opposite to the landing direction, and no less than 150% of the nominal wind components along the landing path in the landing direction. This is already taken into account in published figures and corrections.

3.2.2. Automatic Landing

JAR AWO

The required landing distance must be established and scheduled in the airplane Flight Manual, if it exceeds the scheduled manual landing distance.

On a dry runway, the ALD in autoland is defined as follows:

$$ALD = (D_a + D_g)$$

Where : D_a is the airborne phase distance
 D_g is the ground phase distance.

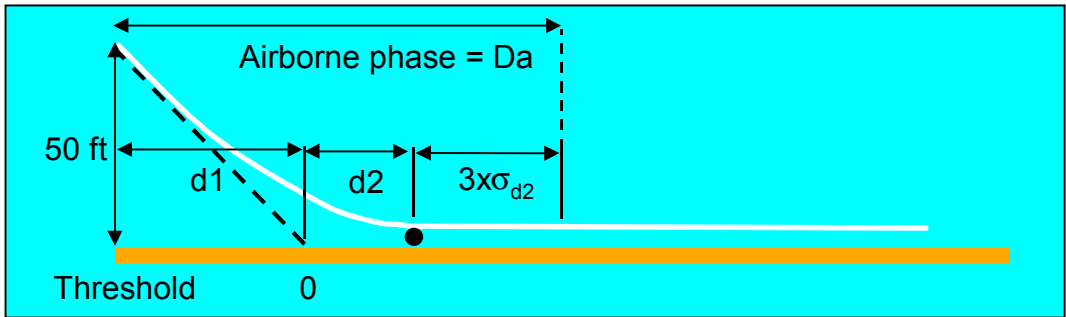

Figure E5 : Airborne Phase

The airborne phase D_a is the distance from the runway threshold up to the glideslope origin (d_1), plus the distance from the glideslope origin up to the mean touchdown point (d_2), plus three times the standard deviation of d_2 (σ_{d_2}).

The distance from the glideslope origin to the mean touchdown point (d_2), as well as its corresponding standard deviation (σ_{d_2}), have been statistically established from the results of more than one thousand simulated automatic landings.

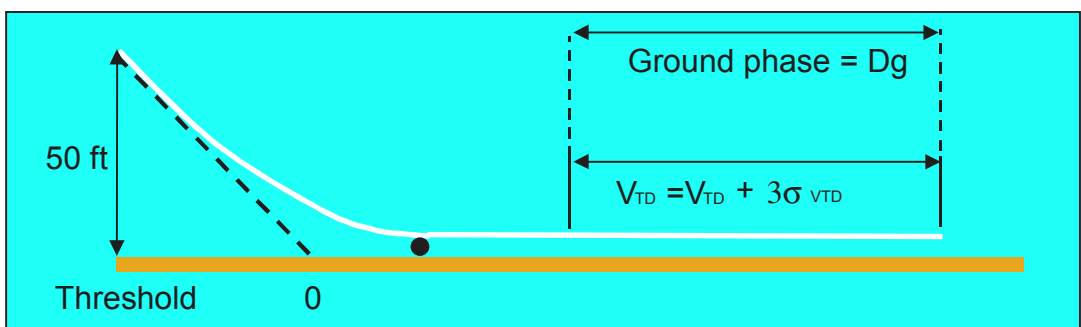

Figure E6 : Ground Phase

The Ground Phase D_g for an automatic landing is established as with a manual landing, assuming a touchdown speed equal to the mean touchdown speed (V_{TD}) plus three times the standard deviation of this speed ($\sigma_{V_{TD}}$).

3.3. Go-Around Performance Requirements

A minimum climb gradient must be observed, in case of a go-around. The minimum air climb gradients depend on the aircraft type.

3.3.1. Approach Climb

JAR 25.121 Subpart B

FAR 25.121 Subpart B

This corresponds to an aircraft's climb capability, assuming that one engine is inoperative. The "approach climb" wording comes from the fact that go-around performance is based on approach configuration, rather than landing configuration. For Airbus fly-by-wire aircraft, the available approach configurations are CONF 2 and 3.

3.3.1.1. Aircraft Configuration

- One engine inoperative
- TOGA thrust
- Gear retracted
- Slats and flaps in approach configuration (CONF 2 or 3 in most cases)
- $1.23 V_{S1g} \leq V \leq 1.41 V_{S1g}$ and check that $V \geq VMCL$

3.3.1.2. Requirements

The minimum gradients to be demonstrated:

		Approach Climb
Minimum climb gradient one engine out	Twin	2.1%
	Quad	2.7%

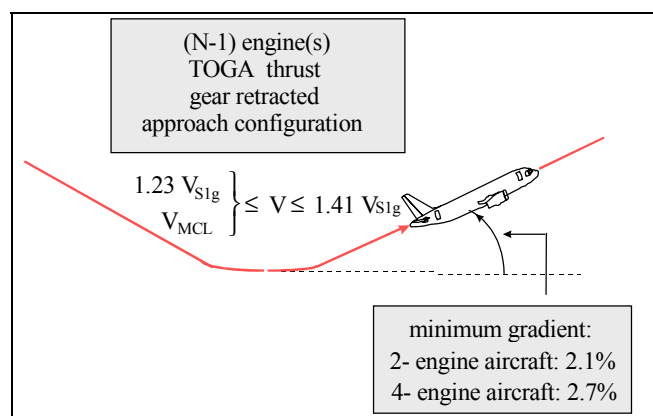

Figure E7: Minimum Air Climb Gradients - Approach Climb

An approach configuration can be selected, as long as the stall speed V_{S1g} of this configuration does not exceed **110% of V_{S1g}** of the related “all-engines-operating” landing configuration.

3.3.2. Landing Climb

JAR 25.119 Subpart B

FAR 25.119 Subpart B

The objective of this constraint is to ensure aircraft climb capability in case of a missed approach with all engines operating. The “Landing climb” wording comes from the fact that go-around performance is based on landing configuration. For Airbus FBW, the available landing configurations are CONF 3 and FULL.

3.3.2.1. Configuration

- N engines
- Thrust available 8 seconds after initiation of thrust control movement from minimum flight idle to TOGA thrust
- Gear extended
- Slats and flaps in landing configuration (CONF 3 or FULL)
- $1.13 V_{S1g} \leq V \leq 1.23 V_{S1g}$ and check that $V \geq V_{MCL}$.

3.3.2.2. Requirements

The minimum gradient to be demonstrated is **3.2%** for all aircraft types.

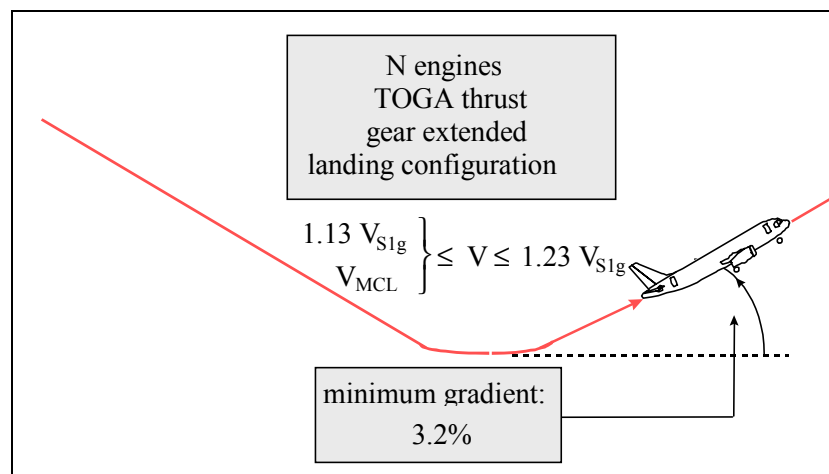

Figure E8: Minimum Air Climb Gradients - Landing Climb

For all Airbus aircraft, this constraint is covered by the approach climb requirement. In its operational documentation (FCOM), Airbus publishes the maximum weight limited by the approach climb gradient only. Landing climb performance is found in the AFM.

3.4. External Parameters Influence

3.4.1. Pressure Altitude

Approach speed is equal to $1.23 V_{S1g}$. But, the corresponding TAS increases with the pressure altitude.

$$PA \nearrow \Rightarrow \rho \searrow \Rightarrow TAS \nearrow$$

Consequently, the landing distance will also increase.

TOGA thrust, used for go-around, decreases when pressure altitude increases.

$$PA \nearrow \Rightarrow \text{engine thrust} \searrow$$

Therefore, in the event of a go-around, a decrease in engine thrust implies a decrease in the air climb gradients, which means that:

$$PA \nearrow \Rightarrow \begin{cases} \text{landing distance} \nearrow \\ \text{air climb gradients} \searrow \end{cases}$$

3.4.2. Temperature

Engine thrust decreases when the temperature passes the reference temperature. Therefore, in case of a go-around, the air climb gradients will decrease.

$$\text{Temp} \nearrow \Rightarrow \text{go-around air climb gradients} \searrow$$

3.4.3. Runway Slope

JAR-OPS 1.515 (b) Subpart G

From a performance standpoint, an upward slope improves the aircraft's stopping capability, and, consequently, decreases landing distance.

$$\begin{array}{lll} \text{Upward slope} & \Rightarrow & \text{Landing distance} \searrow \\ \text{Downward slope} & \Rightarrow & \text{Landing distance} \nearrow \end{array}$$

3.4.4. Runway Conditions

The definition of runway conditions is the same as for takeoff. When the runway is contaminated, landing performance is affected by the runway’s friction coefficient, and the precipitation drag due to contaminants.

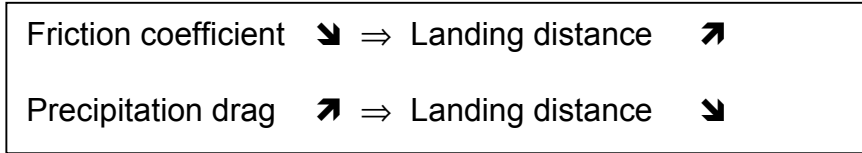

Depending on the type of contaminant and its thickness, landing distance can either increase or decrease. So, it is not unusual to have a shorter ALD on 12.7 mm of slush than on 6.3mm.

3.4.5. Aircraft Configuration

3.4.5.1. Engine air bleed

Engine air bleed for de-icing or air conditioning, implies a decrease in engine thrust.

As a result, go-around air climb gradients will decrease.

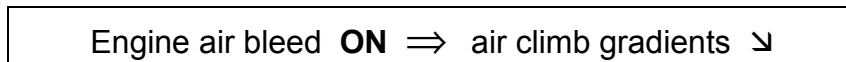

3.4.5.2. Flap setting

An increase in flap deflection implies an increase in the lift coefficient (C_L), and in the wing surface. It is therefore possible to reduce speed such that the aircraft will need a shorter distance to land ($V_{S1G CONF FULL} < V_{S1G CONF 3}$).

When wing flap deflection increases, landing distance decreases.

However, when flap deflection increases, drag increases thus penalizing the aircraft’s climb performance.

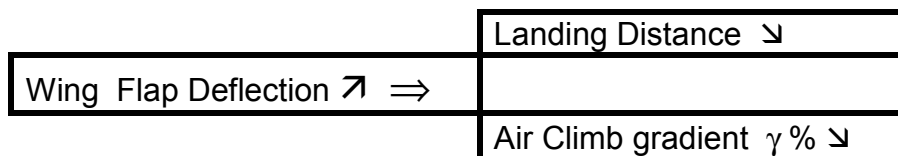

When landing at a high altitude airport with a long runway, it might be better to decrease the flap setting to increase the go-around air climb gradient.

4. DISPATCH REQUIREMENTS

4.1. Required Landing Distance (RLD)

JAR-OPS 1.515 (c) Subpart G

FAR 121.195 (b) Subpart I

It is assumed “that the aeroplane will land on the most favorable runway, in still air”. Furthermore, “the aeroplane will land on the runway most likely to be assigned considering the probable wind speed and direction and the ground handling characteristics of the aeroplane, and considering other conditions such as landing aids and terrain”.

Before departure, operators must check that the Landing Distance Available (LDA) at destination is at least equal to the Required Landing Distance (RLD) for the forecasted landing weight and conditions.

The RLD, based on certified landing performance (ALD), has been introduced to assist operators in defining the **minimum distance required at destination**, and allow flight **dispatch**.

In all cases, the requirement is : $\boxed{\text{RLD} \leq \text{LDA}}$

Operators must take into account the runway slope, when its value is greater than $\pm 2\%$. Otherwise, it is considered to be null.

In the event of an aircraft system failure, known prior to dispatch and affecting the landing distance, the available runway length must at least be equal to the required landing distance with failure. This distance is equal to the required landing distance without failure multiplied by the coefficient given in the MMEL, or to the performance with failure given by the Flight Manual.

4.1.1. RLD Dry Runways

JAR-OPS 1.515 (a) Subpart G

FAR 121.195 and 197 Subpart I

The aircraft’s landing weight must permit landing within 60% of the Landing Distance Available at both the destination and any alternate airport. That gives:

$$\boxed{\text{RLD}_{\text{dry}} = \text{ALD} / 0.6 \leq \text{LDA}}$$

4.1.2. RLD Wet Runways

JAR-OPS 1.520 Subpart G

FAR 121.195 Subpart I

If the surface is wet, the required landing distance must be at least 115% of that of a dry surface.

$RLD_{wet} = 1.15 RLD_{dry} \leq LDA$

A landing distance on a wet runway, shorter than that above but no less than that required on a dry runway, may be used if the Airplane Flight Manual includes specific additional information about landing distances on wet runways. This is not generally the case for Airbus aircraft.

4.1.3. RLD Contaminated Runways

JAR-OPS 1.520 Subpart G

For JAR operators, if the surface is contaminated, the required landing distance must be at least the greater of the required landing distance on a wet runway and 115% of the landing distance determined in accordance with approved contaminated landing distance data.

$RLD_{contaminated} = \text{the greatest of}$	$ALD_{contaminated} \times 1.15$
	or
	RLD_{wet}

For contaminated runways, the manufacturer must provide landing performance for speed V at 50 feet above the airport, such that:

$1.23 V_{S1g} \leq V \leq 1.23 V_{S1g} + 10 \text{ kt}$

In certain contaminated runway cases, the manufacturer can provide detailed instructions such as antiskid, reverse, airbrakes, or spoiler. And, in the most critical cases, landing can be prohibited.

4.1.4. RLD with Automatic Landing (DRY)

Regulations define the required landing distance for automatic landing as the actual landing distance in automatic landing multiplied by 1.15.

This distance must be retained for automatic landing, whenever it is greater than the required landing distance in manual mode.

$RLD_{automatic} = \text{the greatest of}$	$ALD_{automatic} \times 1.15$
	or
	RLD_{manual}

4.2. Go-Around Requirements

4.2.1. Normal Approach

JAR 25.121 Subpart B

FAR 25.121 Subpart B

During dispatch, only the approach climb gradient needs to be checked, as this is the limiting one.

The minimum required gradient is the one defined during aircraft certification (C.f. 3.3.1 Approach Climb). Operators have a choice of go-around speed (from $1.23 V_{S1g}$ to $1.41 V_{S1g}$), and configuration (3 or 2) to determine the Maximum weight limited by go-around gradient.

In the rare case of a go-around limitation during dispatch, operators can select CONF 2 and $1.4 V_{S1g}$ for go-around calculation, and should no longer be limited. Nevertheless, even if the regulation authorizes such assumptions, it is important to warn pilots about the speed and configuration retained, as soon as they are not standard (CONF 3 and $1.23 V_{S1g}$).

In a normal approach, the required climb gradient is **2.1%** for twin and **2.7%** for four engine aircraft, independently of airport configuration and obstacles. During dispatch, operators can account for the gradient published in the airport approach chart.

4.2.2. CAT II or CAT III Approach

JAR-OPS 1.510 Subpart B & AWO 236

“JAR-OPS 1.510

(a) For instrument approaches with decision heights below 200 ft, an operator must verify that the approach mass of the aeroplane, taking into account the take-off mass and the fuel expected to be consumed in flight, allows a missed approach gradient of climb, with the critical engine failed and with the speed and configuration used for go-around of at least 2.5%, or the published gradient, whichever is the greater. The use of an alternative method must be approved by the Authority”.

In case of a **CAT II/III approach**, the gradient is **2.5%** (all aircraft types) **or more** if the approach charts require a higher value for obstacle consideration.

4.3. Conclusion

- Landing weight must satisfy the structural constraints. So, the first limitation is:

$$LW \leq \text{maximum structural landing weight}$$

- Landing weight is limited by aircraft performance (runway limitation and go-around limitation). Thus, the second condition is:

$LW \leq \text{maximum performance landing weight}$

- Therefore, from these two conditions, it is possible to deduce the expression of the **maximum allowed landing weight called maximum regulatory landing weight (MLW)**:

MLW = minimum	<div style="display: flex; align-items: center; justify-content: center;"> <div style="font-size: 3em; margin-right: 10px;">{</div> <div style="text-align: center;"> <p>maximum structural landing weight</p> <hr style="width: 80%; margin: 5px auto;"/> <p>maximum landing weight limited by performance</p> </div> <div style="font-size: 3em; margin-left: 10px;">}</div> </div>
---------------	---

5. IN-FLIGHT REQUIREMENTS

5.1. In-Flight Failure

JAR-OPS 1.400 Subpart D

FAR 25.473 Subpart C

“JAR-OPS 1.400

Before commencing an approach to land, the commander must satisfy himself that, according to the information available to him, the weather at the aerodrome and the condition of the runway intended to be used should not prevent a safe approach, landing or missed approach, having regard to the performance information contained in the Operations Manual.

The in-flight determination of the landing distance should be based on the latest available report, preferably not more than 30 minutes before the expected landing time.”

In the event of an aircraft system failure occurring in flight, and affecting landing performance, the runway length to be considered for landing is the actual landing distance without failure multiplied by the landing distance coefficient associated to the failure.

These coefficients, as well as the ALDs for each runway state, are published in Airbus’ operational documentation (Flight Crew Operating Manual and Quick Reference Handbook).

Note that the required landing distance concept no longer applies and the margins retained for alternate airport selection are at the captain’s discretion.

5.2. Overweight Landing Requirements

In exceptional conditions (in-flight turn-back or diversion), an immediate landing at a weight above the Maximum Landing weight is permitted, provided pilots follow the abnormal overweight procedure.

JAR 25.473 Subpart C

FAR 25.473 Subpart C

The aircraft's structural resistance is protected for a landing at the Maximum structural Takeoff Weight (MTOW), with a rate of descent of -360 feet per minute.

Nevertheless, the minimum required air climb gradients, in the case of a go-around, must be complied with. For certain aircraft types, the go-around can be performed in CONF 1+F if the climb gradient cannot be achieved in CONF 2. The landing configuration is then CONF 3. That's possible when V_{S1g} (CONF 1+F) < 110% V_{S1g} (CONF 3).

5.3. Fuel Jettisoning Conditions

JAR 25.1001 Subpart A

FAR 25.1001 Subpart E

“JAR/FAR 25.1001

A fuel jettisoning system must be installed on each aeroplane unless it is shown that the aeroplane meets the climb requirements of Approach Climb gradient and Landing Climb gradient at maximum take-off weight, less the actual or computed weight of fuel necessary for a 15-minute flight comprised of a take-off, go-around, and landing at the airport of departure with the aeroplane configuration, speed, power, and thrust the same as that used in meeting the applicable take-off, approach, and landing climb performance requirements of this JAR-25.”

When the Maximum Takeoff Weight (MTOW), less the weight of fuel necessary for a 15-minute flight (including takeoff, approach, and landing at the departure airport) is more than the maximum go-around weight, a fuel jettisoning system must be available.

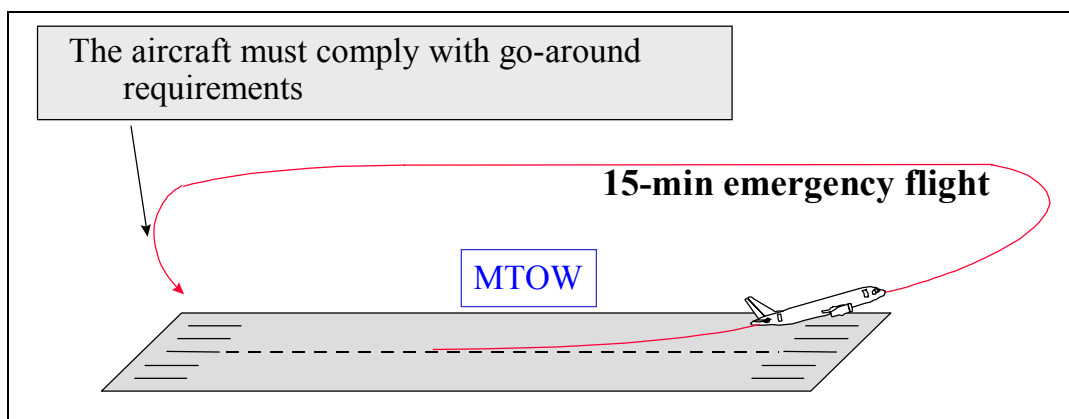

Figure E9: Fuel Jettisoning

F. CRUISE

1. GENERAL

1.1. Introduction

The main objective of the previous chapters is to comply with the airworthiness requirements of JAR/FAR 25 and JAR-OPS 1/FAR 121. This section deals with another objective. That of decreasing **Direct Operating Costs (DOC)**.

Direct Operating Costs include:

- Fixed costs (taxes, insurance, etc...),
- Flight-time related costs (crew, hourly maintenance costs, depreciation),
- Fuel-consumption related costs.

The right choice of flight level and speed allows these DOCs to be minimized. In other words, as time and fuel consumption are closely related, cruise planning is established by making the right speed and flight level choices. In the following chapters, we will review some speed and altitude optimization criteria.

1.2. Specific Range

The **specific range (SR)** is the distance covered per fuel unit. Basically speaking, the specific range is equal to:

$$SR_{(Ground)} = \frac{\text{ground speed (GS)}}{\text{fuel consumption per hour (FF)}}$$

Considering air distance, the specific range is equal to:

$$SR_{(Air)} = \frac{\text{true air speed (TAS)}}{\text{fuel consumption per hour (FF)}}$$

As TAS is expressed in nautical miles per hour (NM/h), and Fuel Flow (FF) in kilograms per hour (kg/h), the SR is expressed in NM/kg or NM/ton.

Moreover, SR depends on aerodynamic characteristics (Mach and L/D), engine performance (Specific Fuel Consumption)¹, aircraft weight (mg) and sound velocity at sea level (a_0).

¹ The Specific Fuel Consumption (SFC) is equal to the fuel flow (FF) divided by the available thrust. It is expressed in kg/h.N (kilogram per hour per Newton) and represents the fuel consumption per thrust unit.

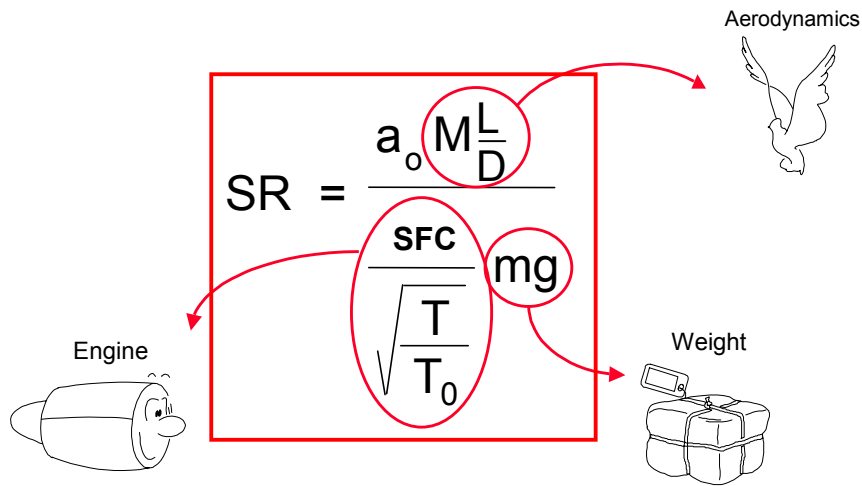

M . L/D ↗	⇒	SR ↗
m ↗	⇒	SR ↘
SFC ↗	⇒	SR ↘

2. SPEED OPTIMIZATION

2.1. All Engine Operating Cruise Speeds

2.1.1. Maximum Range Mach Number (M_{MR})

Figure F1 illustrates the specific range as a function of Mach number for a given weight at a constant altitude.

As a result, for a given weight, a maximum specific range value exists and the corresponding Mach number is called **Maximum Range Mach number (M_{MR})**.

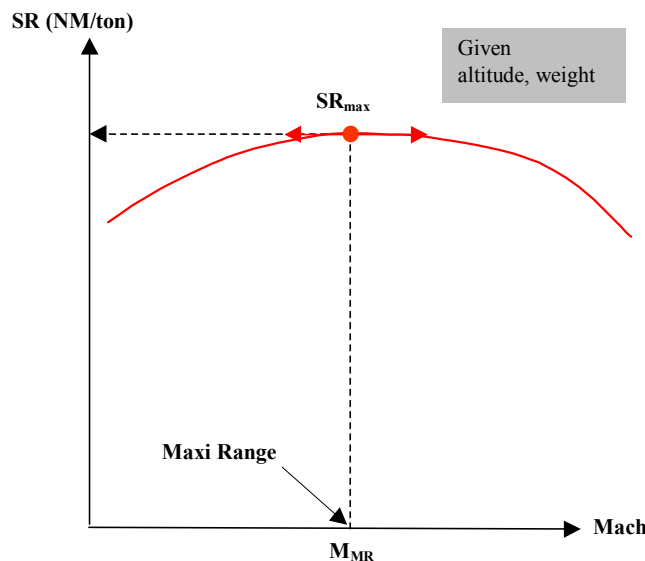

Figure F1: Maximum Range Mach Number

The advantage of the Maximum Range Mach number is that the fuel consumption for a given distance is at its minimum. It also corresponds to the **maximum distance an aircraft can fly with a given fuel quantity.**

During cruise, the aircraft's weight decreases due to fuel burn. At the same time, the specific range increases, but M_{MR} decreases (Figure F2). The Mach number must therefore be adjusted to correspond to weight changes during the entire flight at constant altitude.

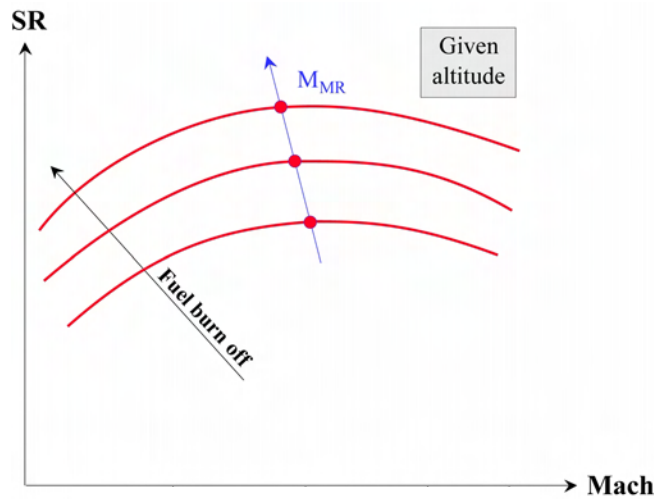

Figure F2: Maximum Range Mach Number versus Weight

• **Pressure Altitude Influence**

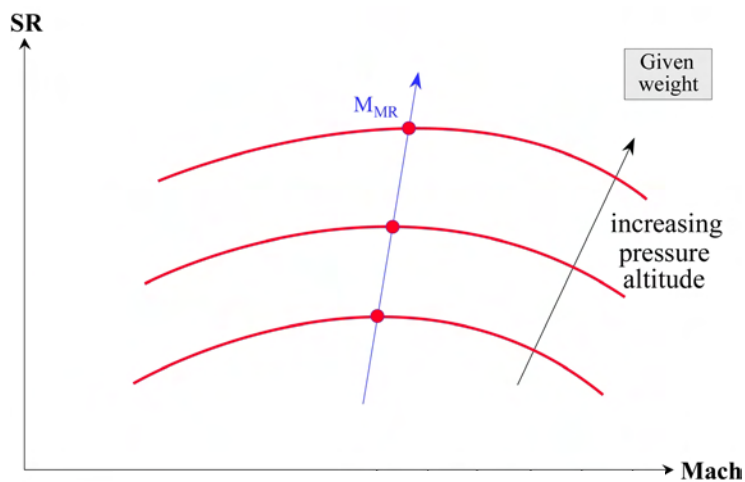

Figure F3: Maximum Range Mach Number versus Pressure Altitude

Variations of the maximum range Mach number are summarized as follows:

PA = constant	weight	↘	⇒	M_{MR}	↘
weight = constant	PA	↗	⇒	M_{MR}	↗

2.1.2. Long-Range Cruise Mach Number (M_{LRC})

An alternative to M_{MR} is to increase cruise speed with only a slight increase in fuel consumption. Typically, the long-range cruise Mach number (M_{LRC}) provides this possibility.

At the long-range cruise Mach number, the specific range corresponds to **99%** of the maximum specific range (Figure F4). Economically speaking, the 1% loss compared to the maximum specific range is largely compensated by the cruise speed increase due to the flatness of the curve.

$$M_{LRC} > M_{MR}$$

$$SR_{long\ range} = 0.99 \times SR_{max\ range}$$

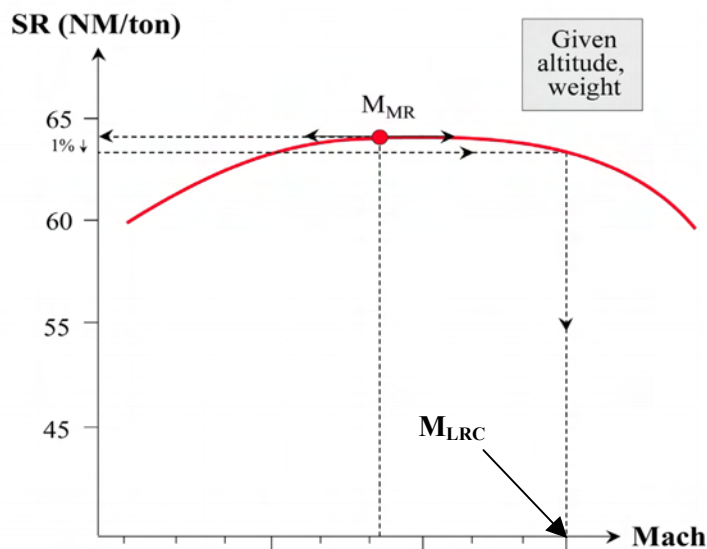

Figure F4: Long Range Cruise Mach Number Definition

In relation to the Maximum Range Mach number, the long-range Cruise Mach number also decreases when weight decreases, as shown in Figure F5.

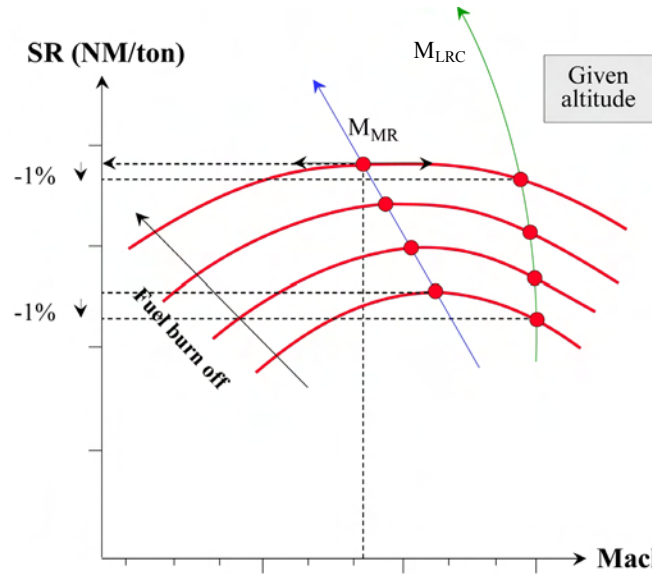

Figure F5: Long Range Cruise Mach Number versus Weight

PA = constant	weight ↓	⇒ LRC ↓
weight = constant	PA ↑	⇒ LRC ↑

2.1.3. Economic Mach Number (M_{ECON})

Long-range Cruise Mach number was considered as a minimum fuel regime. If we consider the Direct Operating Cost instead, the **Economic Mach number** (M_{ECON}), can be introduced.

As indicated in §1.1, DOCs are made up of fixed, flight-time related and fuel-consumption related costs. As a result, for a given trip, DOC can be expressed as:

$$DOC = C_C + C_F \cdot \Delta F + C_T \cdot \Delta T$$

That is:

C_C = fixed costs

C_F = cost of fuel unit

ΔF = trip fuel

C_T = time related costs per flight hour

ΔT = trip time

As DOCs are calculated per nautical mile, it is possible to plot fuel-related costs, flight-time related costs, and direct operating costs based on Mach number (Figure F6).

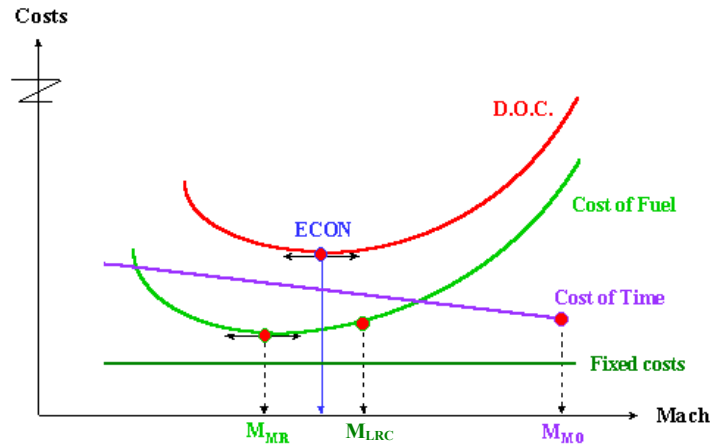

Figure F6: Mach Number and Costs

Minimum fuel costs correspond to the Maximum Range Mach number. The minimum DOC corresponds to a specific Mach number, referred to as Econ Mach (M_{ECON}).

PA = constant	weight	↘	⇒ M_{ECON}	↘
weight = constant	PA	↗	⇒ M_{ECON}	↗

The M_{ECON} value depends on the time and fuel cost ratio. This ratio is called **cost index (CI)**, and is usually expressed in kg/min or 100lb/h:

$$\text{Cost Index (CI)} = \frac{\text{Cost of time}}{\text{Cost of fuel}} = \frac{C_T}{C_F}$$

When C_T is fixed and C_F increases, it becomes interesting to decrease fuel consumption. Therefore, when CI decreases, Econ Mach decreases.

$CI \nearrow \Rightarrow M_{ECON} \nearrow$
$CI \searrow \Rightarrow M_{ECON} \searrow$

The extreme CI values are:

- **CI = 0**: Flight time costs are null (fixed wages), so $M_{ECON} = M_{MR}$ (lowest boundary).
- **CI = CI_{max}**: Flight time costs are high and fuel costs are low, so $M_{ECON} = \text{MAX SPEED}$ in order to have a trip with a minimum flight time. The maximum speed is generally (MMO - 0.02) or (VMO - 10kt).

For instance, a cost index of **30 kg/min** means that the cost of one flight minute is the same as the cost of 30 kg of fuel. This does not mean the fuel flow is 30 kg/min.

2.1.4. Constant Mach Number

The aircraft is often operated at a constant Mach number.

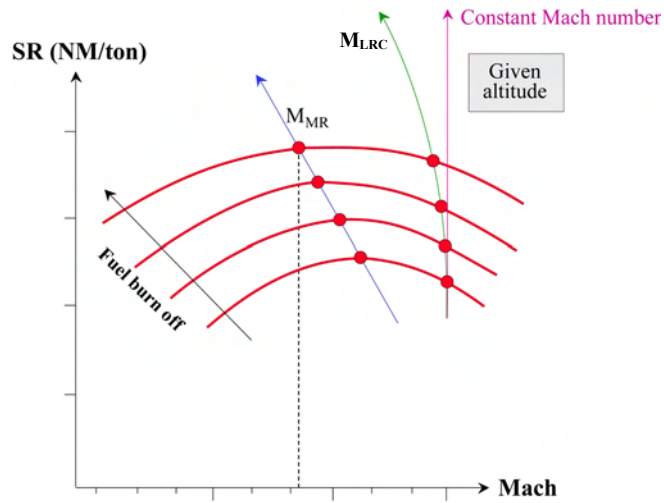

Figure F7: Constant Mach Number

Nevertheless, as the aircraft weight decreases, the gap between the selected Mach and the M_{MR} increases. As a result, fuel consumption increases beyond the optimum.

3. ALTITUDE OPTIMIZATION

3.1. Optimum Cruise Altitude

3.1.1. At a Constant Mach Number

In examining SR changes with the altitude at a constant Mach number, it is apparent that, for each weight, there is an altitude where SR is maximum. This altitude is referred to as “optimum altitude” (see Figure F8).

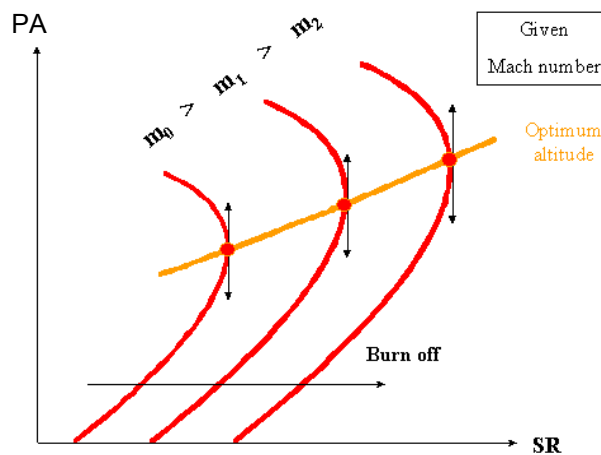

Figure F8: Optimum Altitude Determination at Constant Mach Number

When the aircraft flies at the optimum altitude, it is operated at the maximum lift to drag ratio corresponding to the selected Mach number (as in Figure F9).

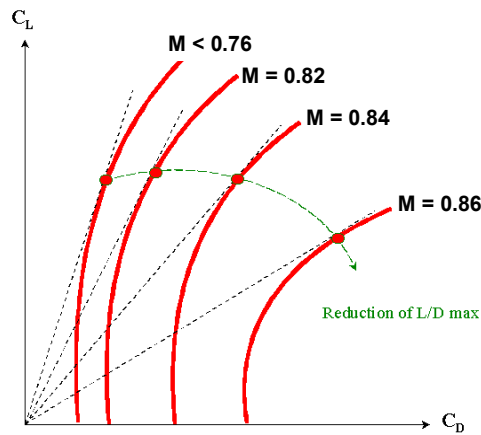

Figure F9: High Speed Polar Curve

When the aircraft flies at high speed, the polar curve depends on the indicated Mach number, and decreases when Mach increases. So, for each Mach number, there is a different value of $(C_L/C_D)_{max}$, that is lower as the Mach number increases.

When the aircraft is cruising at the optimum altitude for a given Mach, C_L is fixed and corresponds to $(C_L/C_D)_{max}$ of the selected Mach number. As a result, variable elements are weight and outside static pressure (P_s) of the optimum altitude. The formula expressing a cruise at optimum altitude is:

$$\frac{\text{Weight}}{P_s} = \text{constant}$$

The optimum altitude curve, illustrated in Figure F10, is directly deduced from Figure F8.

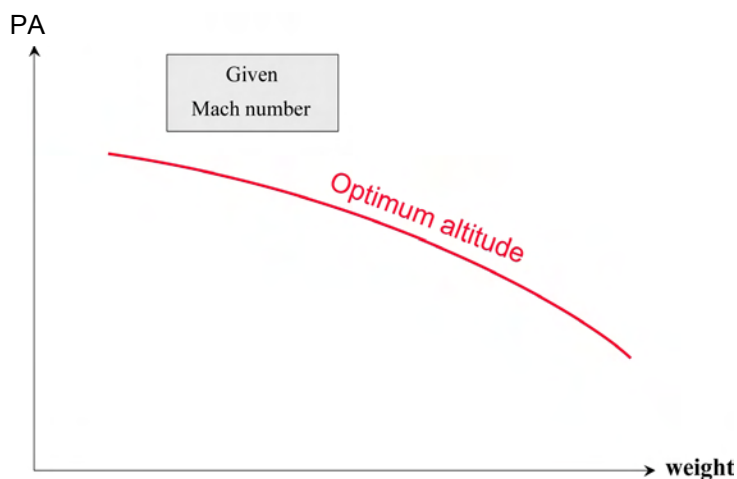
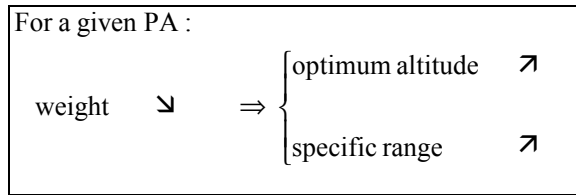

Figure F10: Optimum Altitude and Weight at Constant Mach Number

Summary:



ISO Mach number optimum altitude curves are all quasi-parallel (Figure F11).

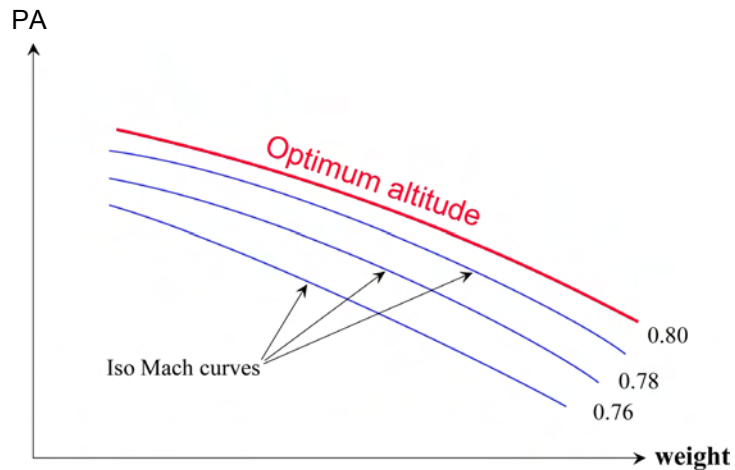

Figure F11: ISO Mach Number Curves

3.1.2. Wind Influence

The M_{MR} (or M_{LRC} or M_{ECON}) value varies with headwind or tailwind, due to changes in the ground SR. Figure F12 shows the Maximum Range Mach number versus wind variations.

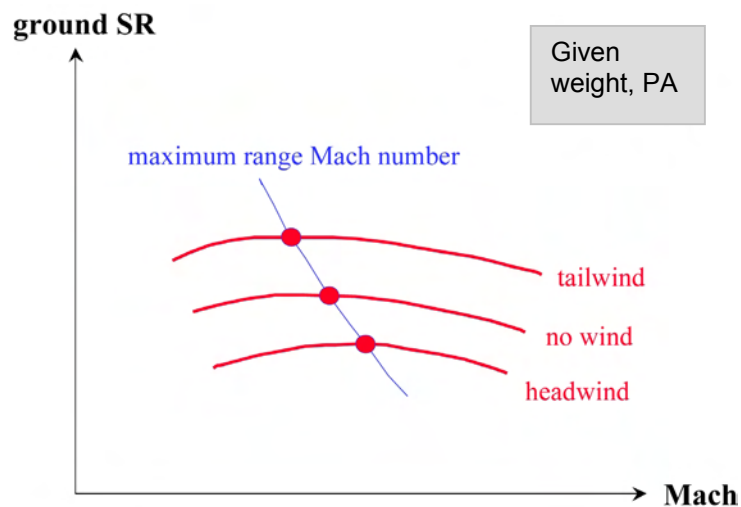

Figure F12: M_{MR} and wind influence

As a result:

tailwind \Rightarrow	}	Ground SR \nearrow
		M_{MR} \searrow
headwind \Rightarrow	}	Ground SR \searrow
		M_{MR} \nearrow

The wind force can be different at different altitudes. For a given weight, when cruise altitude is lower than optimum altitude, the specific range decreases (Figure F8). Nevertheless, it is possible that, at a lower altitude with a favorable wind, the ground specific range improves. When the favorable wind difference between the optimum altitude and a lower one reaches a certain value, the ground-specific range at lower altitude is higher than the ground-specific range at optimum altitude. As a result, in such conditions, it is more economical to cruise at the lower altitude.

Figure F13 indicates the amount of favorable wind, necessary to obtain the same ground-specific range at altitudes different from the optimum:

A319/320/321 FLIGHT CREW OPERATING MANUAL	IN FLIGHT PERFORMANCE CRUISE	3.05.15	P 7
		SEQ 020	REV 24

WIND ALTITUDE TRADE FOR CONSTANT SPECIFIC RANGE

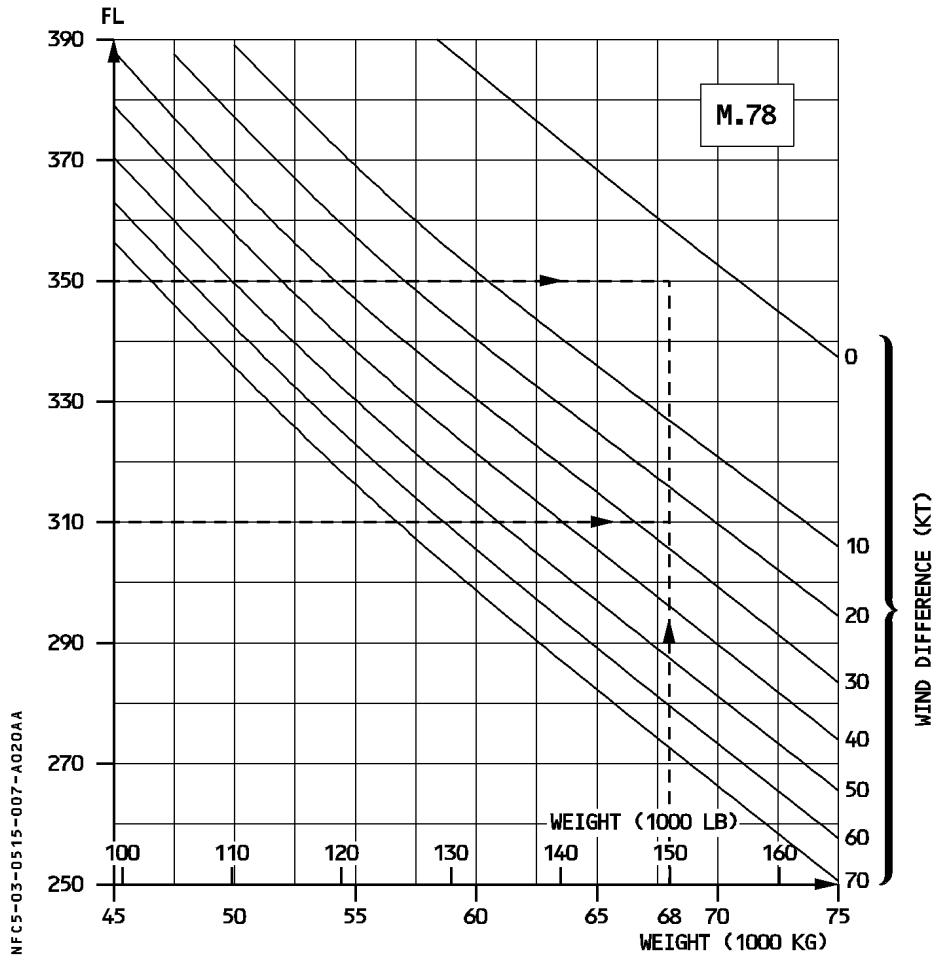

GIVEN : Weight : 68000 kg (150 000 lb)
 Wind at FL350 : 10 kt head
FIND : Minimum wind difference to descend to FL310 : $(26 - 3) = 23$ kt
RESULTS : Descent to FL310 may be considered provided the tail wind at this altitude is more than $(23 - 10) = 13$ kt.

Figure F13: Optimum Altitude and Favorable Wind Difference

3.2. Maximum Cruise Altitude

3.2.1. Limit Mach Number at Constant Altitude

Each engine has a **limited Max-Cruise rating**. This rating depends on the maximum temperature that the turbines can sustain. As a result, when outside temperature increases, maximum thrust decreases (see Figure F14).

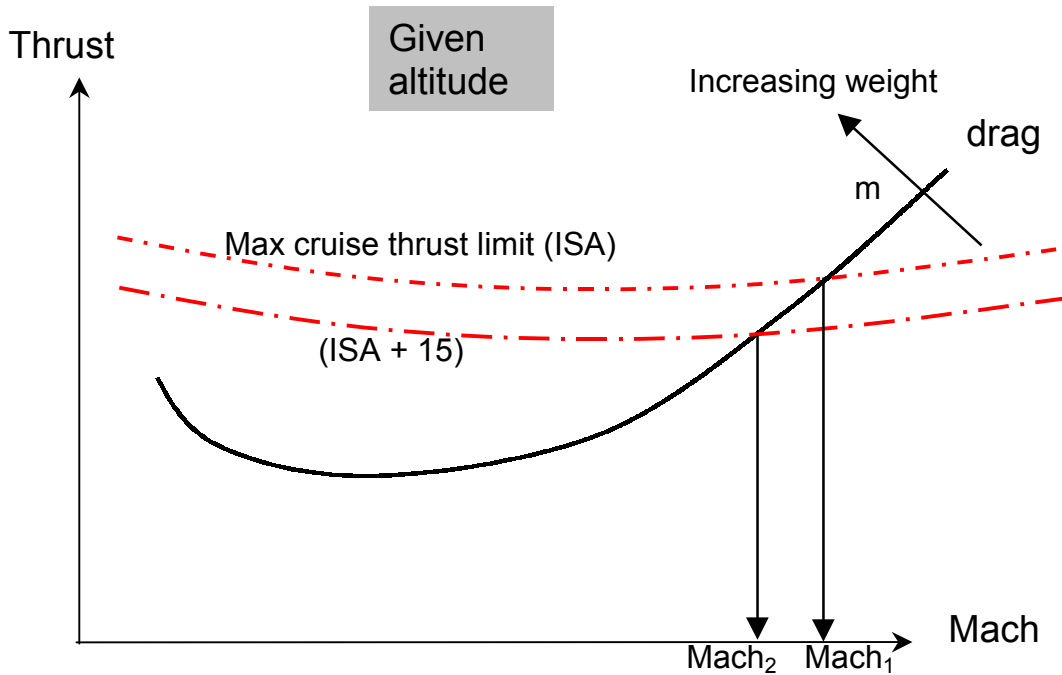

Figure F14: Influence of Temperature on Limit Mach Number at Given Altitude and Weight

Figure F14 illustrates the maximum possible Mach number, as a function of temperature at a given altitude and weight.

The change in limit Mach number at constant altitude can, therefore, be summed up as:

For a given weight: Temperature ↗	⇒	Limit Mach number ↘
For a given temperature: Weight ↗	⇒	Limit Mach number ↘

3.2.2. Maximum Cruise Altitude

On the other hand, when an aircraft flies at a given Mach number, the higher the altitude, the more the thrust must be increased. **The maximum cruise altitude** is defined for a given weight, as the maximum altitude that an aircraft can maintain at maximum cruise thrust when the pilot maintains a fixed Mach number.

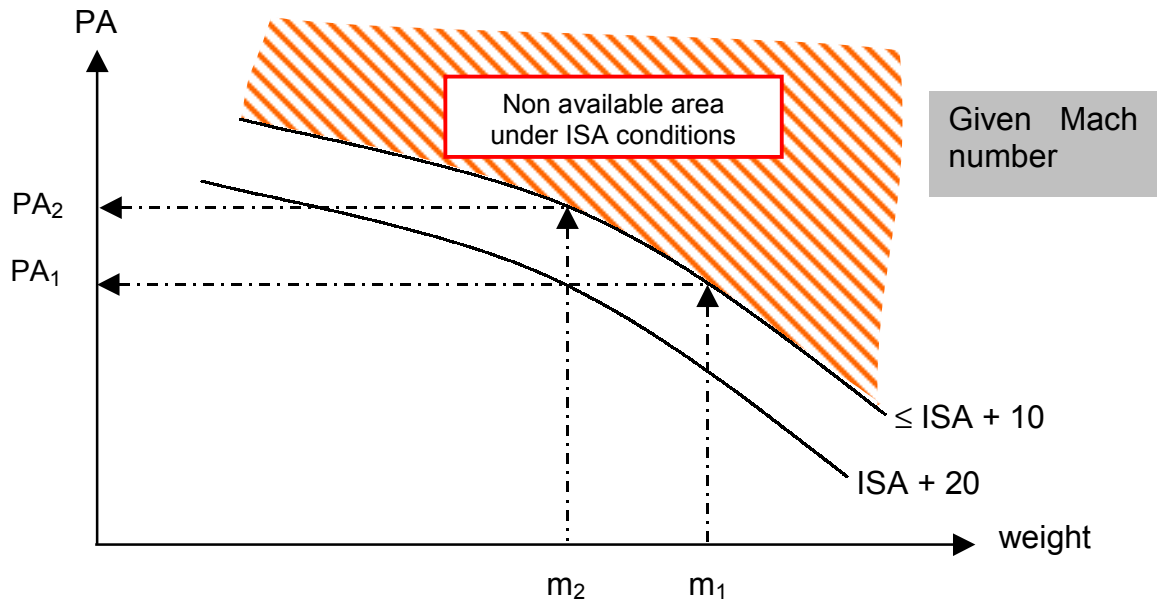

Figure F15: Maximum Altitudes at Maximum Cruise Thrust

From Figure F15, it can be deduced that:

- At m_1 , the maximum altitude is PA_1 for temperatures less than $ISA + 10$
- At m_2 , the maximum altitude is PA_2 for temperatures less than $ISA + 10$, but PA_1 for temperatures equal to $ISA + 20$.

Maximum cruise altitude variations can be summed up as:

weight	↗	⇒	Maximum cruise altitude	↘
temperature	↗	⇒	maximum cruise altitude	↘
Mach number	↗	⇒	maximum cruise altitude	↘

Figure F16 illustrates how maximum and optimum altitudes are shown in an A330 FCOM:

 FLIGHT CREW OPERATING MANUAL	IN FLIGHT PERFORMANCE CRUISE		3.05.15	P 6
			SEQ 055	REV 06

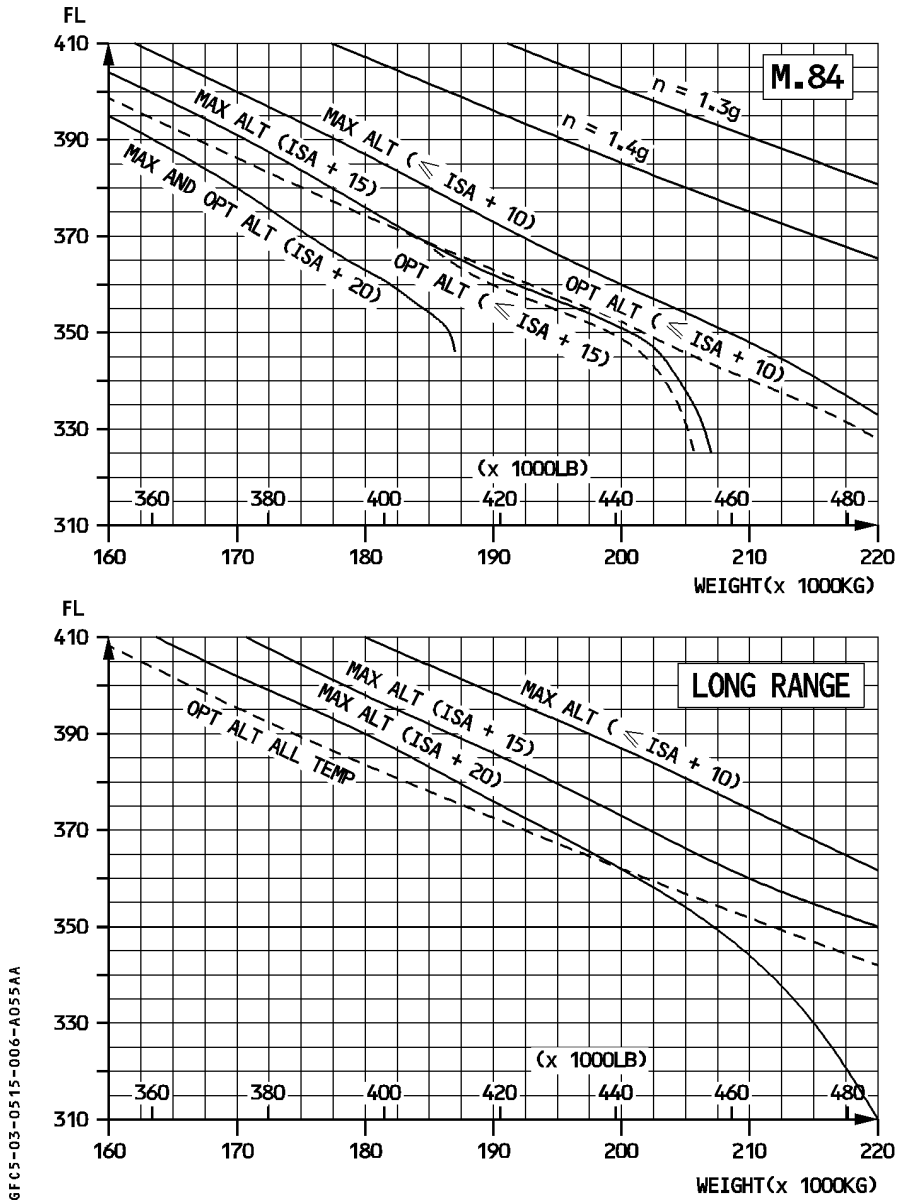

Figure F16: Maximum and Optimum Altitude

3.3. En route Maneuver Limits

3.3.1. Lift Range

In level flight, lift balances weight and, when C_L equals C_{Lmax} , the lift limit is reached. At this point, if the angle of attack increases, a stall occurs.

Lift limit equation: $mg = 0.7 S P_s C_{Lmax} M^2$

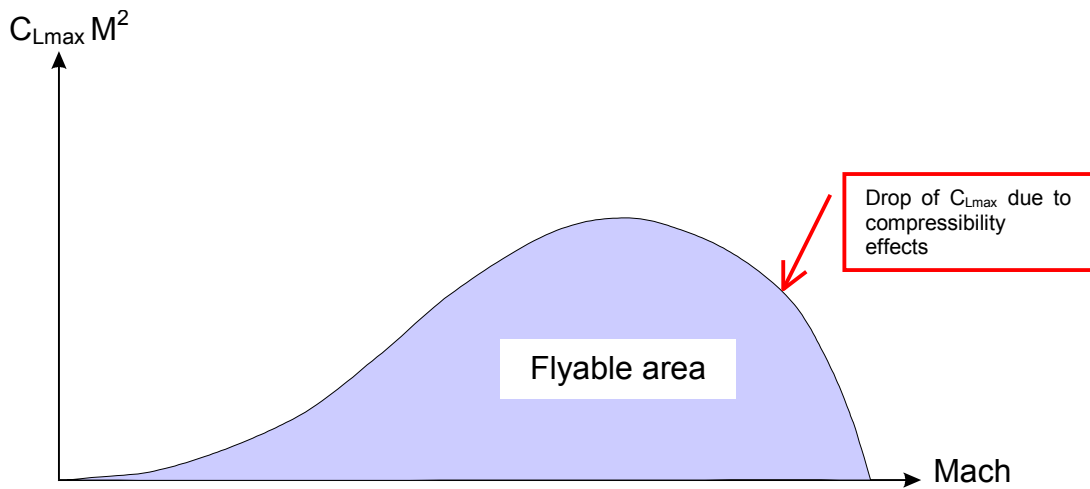

Figure F17: $C_{Lmax} M^2$ Curve versus Mach Number

At a given weight, depending on the lift limit equation, each $C_{Lmax} \cdot M^2$ value corresponds to a static pressure (P_s) value. That is, a pressure altitude (PA). Therefore, there is a direct relationship between $C_{Lmax} \cdot M^2$ and PA.

Figure F18 shows that, for a given PA, flight is possible between M_{min} and M_{max} . When PA increases, the Mach range decreases until it is reduced to a single point corresponding to the lift ceiling (PA_{max}).

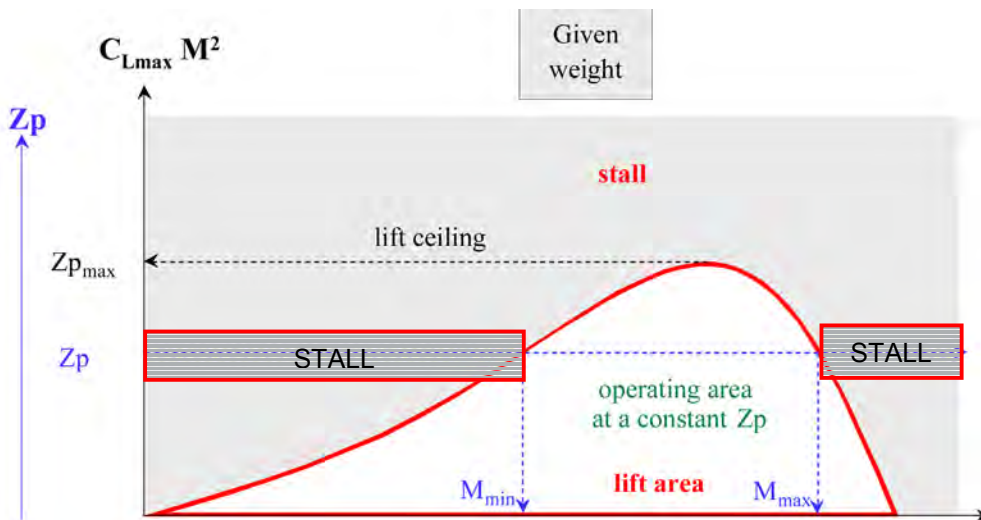

Figure F18: Lift Area Definition

3.3.2. Operating Maneuver Limitations

3.3.2.1. Buffet phenomenon

Concerning the **low Mach number limit**, when speed decreases, the angle of attack must be increased in order to increase the lift coefficient, which keeps the forces balanced.

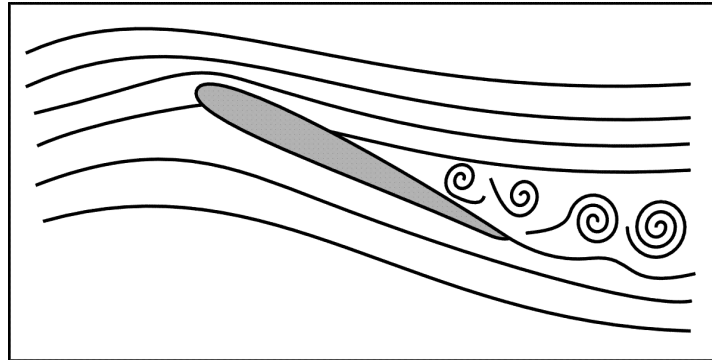

Figure F19: Low Speed Stall

In any case, it is not possible to indefinitely increase the angle of attack (AoA). At a high AoA, the airflow separates from the upper wing surface. If the AoA continues to increase, the point of airflow separation is unstable and rapidly fluctuates back and forth. Consequently, the pressure distribution changes constantly and also changes the lift's position and magnitude. This effect is called buffeting and is evidenced by severe vibrations.

When the AoA reaches a maximum value, the separation point moves further ahead and total flow separation of the upper surface is achieved. This phenomenon leads to a significant loss of lift, referred to as a **stall**.

The **high Mach number limit** phenomenon is quite different. In fact, at high speed, compressibility effects produce shock waves on the upper wing surface. When Mach number, and/or AoA increase, the airflow separates from the upper surface behind the shock wave, which becomes unstable and induces buffeting of the same type as encountered in the low speed case.

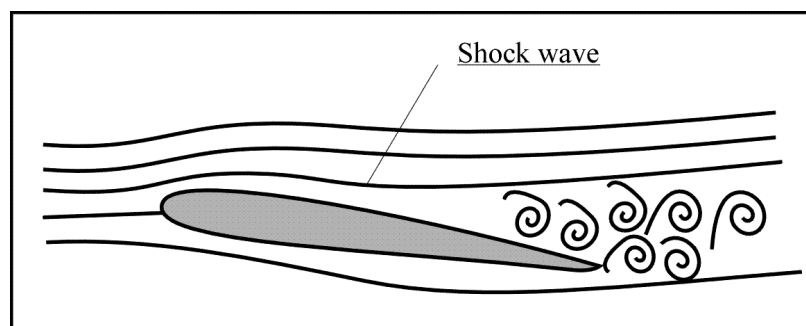

Figure F20: High Speed Airflow

3.3.2.2. Buffet limit

When maneuvering, the aircraft is subject to a load factor expressed as:

$$n = \frac{\text{Lift}}{\text{Weight}}$$

During turns, the load factor value mainly depends on the bank angle, as shown in Figure F21. In fact, in level flight, $n = 1/\cos(\text{bank angle})$.

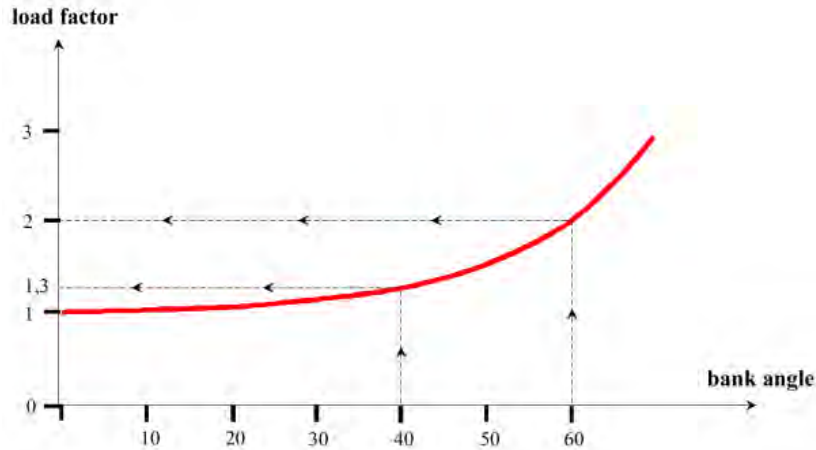

Figure F21: Load Factor versus Bank Angle

At the lift limit,

$$n = \frac{0.7 S P_s C_{L_{max}} M^2}{m g}$$

At a given pressure altitude (P_s) and given weight (mg), **one load factor corresponds to each $C_{L_{max}} M^2$** . Therefore, a curve representing load factor versus Mach number will have the same shape as the one observed in Figure F17.

In fact, the useful limit Mach numbers in operation are the ones for which buffeting occurs.

Figure F22 represents the buffet limit, and for $n = 1$ (level straight flight), a minimum Mach appears for low speed buffet and a maximum Mach for high speed buffet. When n increases, the Mach number range decreases, so that when $n = n_{max}$, $M_{min} = M_{max}$.

So, n_{max} is the maximum admissible load factor at this weight and altitude, and the corresponding Mach number M allows the highest margin regarding buffet limit.

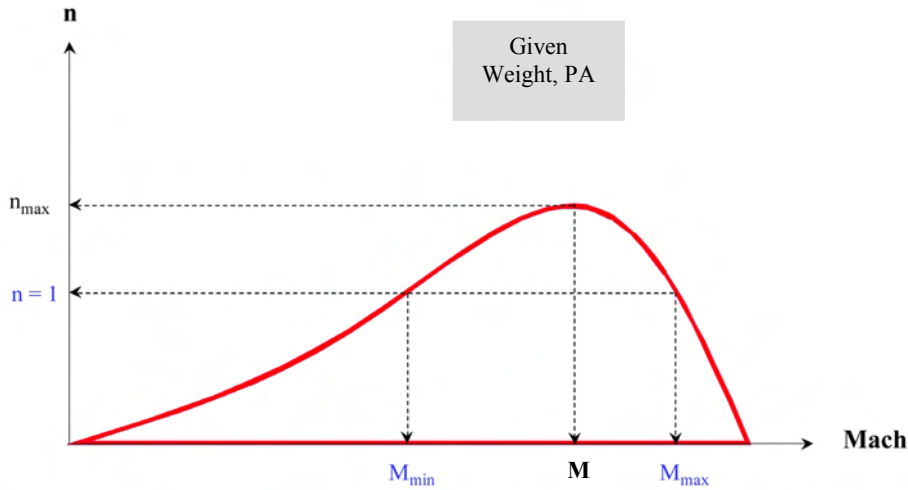

Figure F22: Load Factor and Lift Area

3.3.2.3. Pressure altitude effect

Figure F23 illustrates the effects of pressure altitude on the lift area. It appears that, for a given weight:

$$\text{Pressure altitude} \nearrow \left\{ \begin{array}{l} n_{\max} \searrow \\ \text{lift range} \searrow \end{array} \right.$$

When $n_{\max} = 1$, the aircraft has reached the lift ceiling. For example, in Figure F23, PA_3 corresponds to the lift ceiling at a given weight.

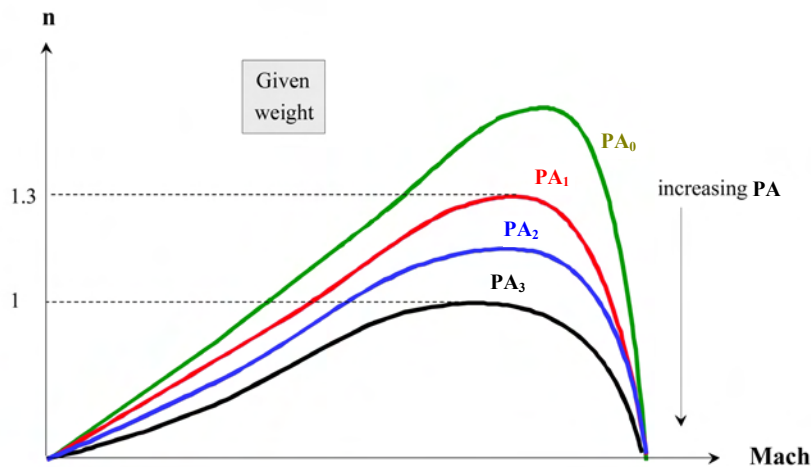

Figure F23: Influence of Pressure Altitude on the Lift Limit

At pressure altitude PA_1 (Figure F23), $n_{\max} = 1.3$. That is to say, it is possible to bear a load factor equal to 1.3, or make a 40° bank turn before buffeting occurs.

In order to maintain a minimum margin against buffeting and ensure good aircraft maneuverability, it is necessary to determine an acceptable load factor limit below which buffeting shall never occur. **This load factor limit is generally fixed to 1.3.** This value is an operating limitation, but not a regulatory one. The corresponding altitude is called the **“1.3g buffet limited altitude”** or **“buffet ceiling”**.

For a given Mach number, Figure F24 represents the 1.3g buffet limited altitude versus weight. At a given Mach number, when weight $\searrow \Rightarrow$ the buffet limited altitude \nearrow .

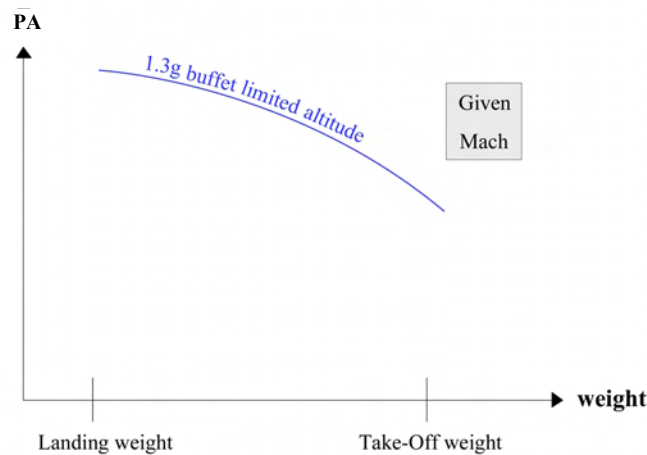

Figure F24: 1.3g Buffet Limited Altitude

As a result, **the maximum recommended altitude** indicated by the FMGS, depending on aircraft weight and temperature conditions, is the lowest of the:

- Maximum certified altitude,
- Maximum cruise altitude,
- 1.3g buffet limited altitude,
- Climb ceiling (see the “Climb” chapter).

3.3.2.4. A320 example

Figure F25 shows how buffet limitations are illustrated in an A320 FCOM.

A319/320/321 FLIGHT CREW OPERATING MANUAL	OPERATING LIMITATIONS GENERAL LIMITATIONS	3.01.20	P 5
		SEQ 001	REV 27

BUFFET ONSET

R

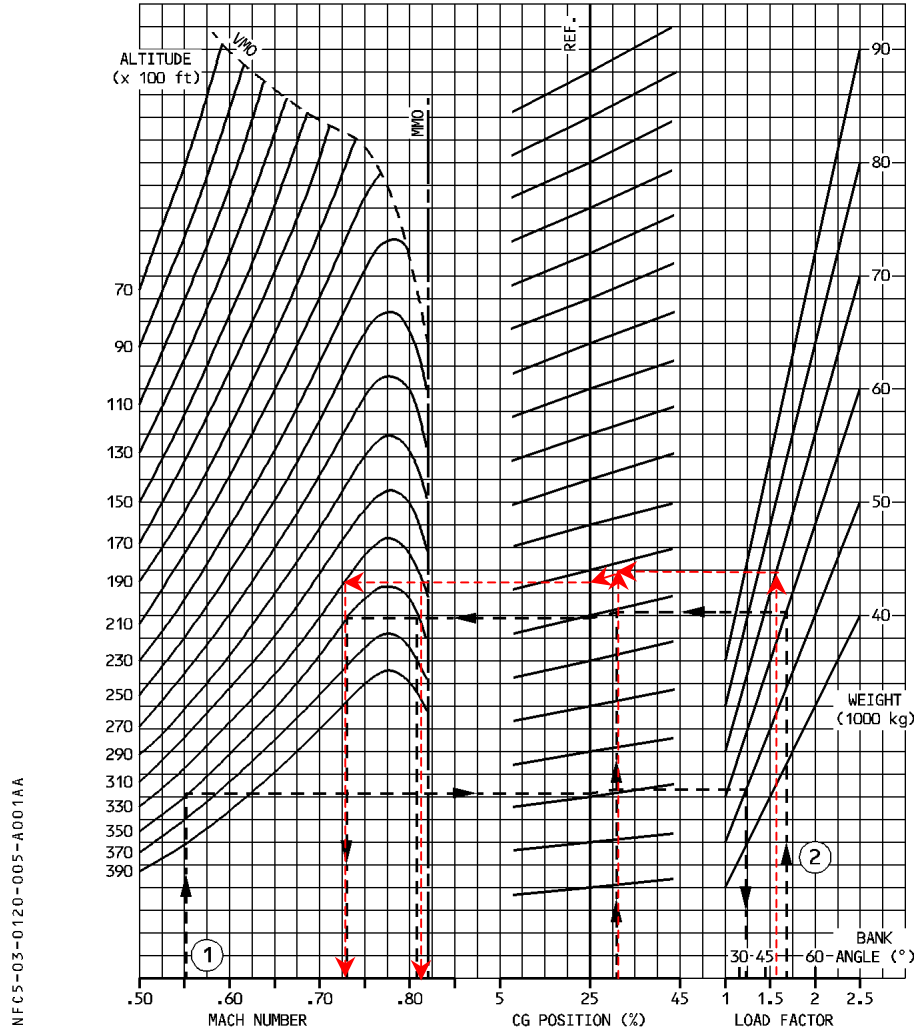

Figure F25: Buffet Onset

<p>Assumptions:</p> <p>n = 1.3 FL330 CG position: 31% Weight: 70 t</p>
--

<p>Results:</p> <p>Speed range: Mmin = M0.73 Mmax = M0.82</p>
--

In practice, for a given weight, the load factor limitation (1.3g) is taken into account as follows:

- At a fixed FL, the cruise Mach number range is determined for n = 1.3g,
- At a fixed cruise Mach number, the maximum FL (buffet ceiling) is determined for n = 1.3g.

3.4. Cruise Optimization: Step Climb

Ideal cruise should coincide with optimum altitude. As a general rule, this altitude is not constant, but increases as weight decreases during cruise. On the other hand, ATC restrictions require level flight cruise. Aircraft must fly by segments of constant altitude which must be as close as possible to the optimum altitude.

In accordance with the separation of aircraft between flight levels, the level segments are established at $\pm 2,000$ feet from the optimum altitude. In general, it is observed that in such conditions:

$$SR \geq 99\% SR_{max}$$

As a result, the following profile is obtained for a step climb cruise (Figure F26).

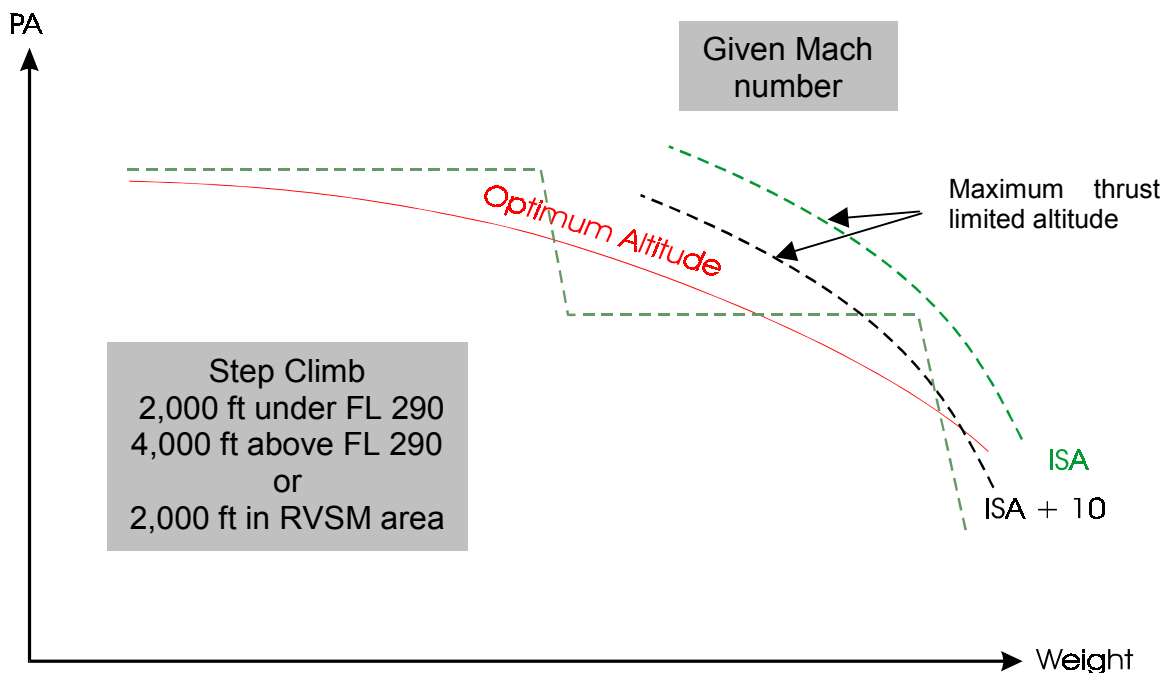

Figure F26: A Step Climb Cruise Profile

Flight levels are selected in accordance with temperature conditions. Usually, the first step is such that it starts at the first usable flight level, compatible with maximum cruise altitude. This is the case with the ISA condition cruise example in Figure F26.

4. FCOM CRUISE TABLE

In the FCOM, cruise tables are established for several Mach numbers in different ISA conditions with normal air conditioning and anti-icing off. Aircraft performance levels are presented in Figure F27.

 A319/320/321 FLIGHT CREW OPERATING MANUAL	IN FLIGHT PERFORMANCE	3.05.15	P 9
	CRUISE	SEQ 110	REV 31

R

CRUISE - M.78													
MAX. CRUISE THRUST LIMITS NORMAL AIR CONDITIONING ANTI-ICING OFF								ISA CG=33.0%		N1 (%) KG/H/ENG NM/1000KG		MACH IAS (KT) TAS (KT)	
WEIGHT (1000KG)	FL290		FL310		FL330		FL350		FL370		FL390		
50	84.0	.780	84.0	.780	84.0	.780	84.1	.780	84.7	.780	85.9	.780	
	1276	302	1189	289	1112	277	1044	264	992	252	955	241	
	180.9	462	192.5	458	204.0	454	215.4	450	225.6	447	234.1	447	
52	84.2	.780	84.2	.780	84.3	.780	84.5	.780	85.1	.780	86.3	.780	
	1288	302	1202	289	1127	277	1060	264	1011	252	977	241	
	179.2	462	190.3	458	201.4	454	212.0	450	221.3	447	229.0	447	
54	84.4	.780	84.5	.780	84.6	.780	84.8	.780	85.5	.780	86.9	.780	
	1300	302	1216	289	1142	277	1079	264	1031	252	1003	241	
	177.5	462	188.1	458	198.6	454	208.4	450	217.0	447	223.1	447	
56	84.7	.780	84.8	.780	84.9	.780	85.2	.780	85.9	.780	87.6	.780	
	1314	302	1231	289	1159	277	1097	264	1052	252	1036	241	
	175.7	462	185.9	458	195.7	454	204.8	450	212.6	447	216.0	447	
58	84.9	.780	85.1	.780	85.2	.780	85.6	.780	86.4	.780	88.3	.780	
	1328	302	1246	289	1176	277	1117	264	1075	252	1070	241	
	173.9	462	183.6	458	192.8	454	201.3	450	208.1	447	209.0	447	
60	85.2	.780	85.3	.780	85.6	.780	85.9	.780	86.9	.780	89.2	.780	
	1342	302	1262	289	1195	277	1137	264	1102	252	1110	241	
	172.0	462	181.3	458	189.8	454	197.6	450	203.0	447	201.5	447	
62	85.5	.780	85.6	.780	85.9	.780	86.3	.780	87.6	.780	90.1	.780	
	1357	302	1279	289	1214	277	1158	264	1135	252	1153	241	
	170.1	462	178.8	458	186.8	454	194.1	450	197.1	447	194.0	447	
64	85.7	.780	85.9	.780	86.2	.780	86.7	.780	88.2	.780			
	1373	302	1297	289	1234	277	1182	264	1170	252			
	168.2	462	176.4	458	183.8	454	190.2	450	191.2	447			
66	86.0	.780	86.2	.780	86.6	.780	87.2	.780	89.0	.780			
	1389	302	1316	289	1254	277	1209	264	1209	252			
	166.2	462	173.9	458	180.9	454	186.0	450	185.0	447			
68	86.2	.780	86.5	.780	86.9	.780	87.8	.780	89.8	.780			
	1406	302	1335	289	1275	277	1242	264	1252	252			
	164.2	462	171.4	458	177.9	454	181.0	450	178.7	447			
70	86.5	.780	86.8	.780	87.3	.780	88.4	.780	90.8	.780			
	1424	302	1355	289	1299	277	1277	264	1298	252			
	162.1	462	168.9	458	174.6	454	176.1	450	172.3	447			
72	86.8	.780	87.1	.780	87.7	.780	89.0	.780					
	1442	302	1375	289	1325	277	1314	264					
	160.0	462	166.4	458	171.2	454	171.1	450					
74	87.1	.780	87.5	.780	88.2	.780	89.8	.780					
	1462	302	1397	289	1357	277	1356	264					
	157.9	462	163.9	458	167.1	454	165.7	450					
76	87.4	.780	87.8	.780	88.8	.780	90.5	.780					
	1482	302	1419	289	1392	277	1400	264					
	155.8	462	161.3	458	162.9	454	160.5	450					
LOW AIR CONDITIONING ΔFUEL = - 0.5 %				ENGINE ANTI ICE ON ΔFUEL = + 2 %				TOTAL ANTI ICE ON ΔFUEL = + 5 %					

Figure F27: Cruise table example

G. CLIMB

1. FLIGHT MECHANICS

1.1. Definitions

The following Figure (G1) shows the different forces applied on an aircraft in climb.

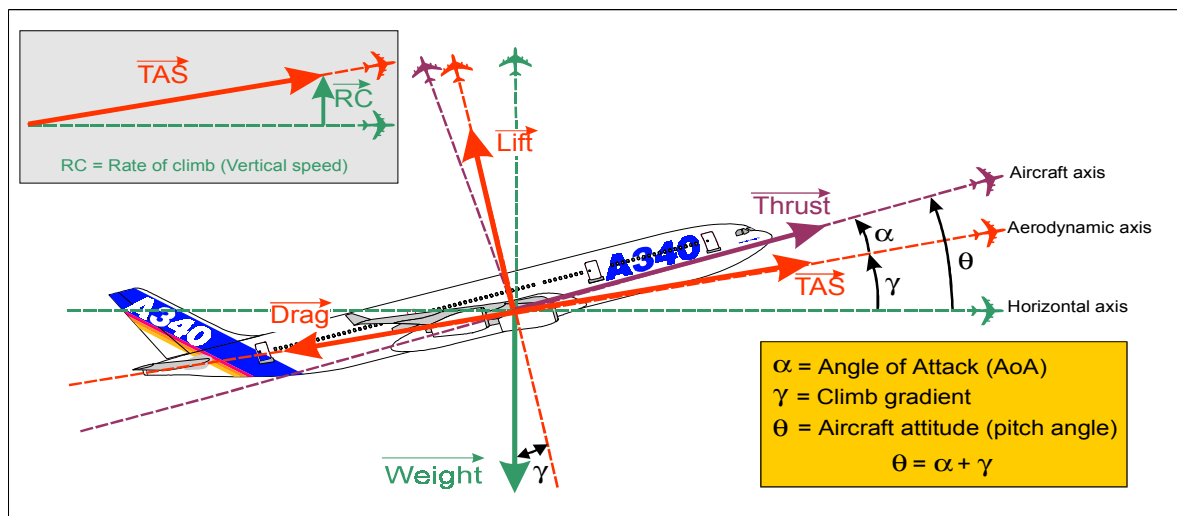

Figure G1: Balance of Forces in Climb¹

- The **angle of attack (α)** represents the angle between the **aircraft axis** and the **aerodynamic axis** (speed vector axis tangent to the flight path).
- The **climb gradient (γ)** represents the angle between the **horizontal axis** and the **aerodynamic axis**.
- The **aircraft attitude (θ)** represents the angle between the **aircraft axis** and the **horizontal axis** (in a ground reference system).
- The **rate of climb (RC)** represents the **vertical component of the aircraft's speed**. It is positive and expressed in feet per minute.

1.2. Climb Equations

During climb at constant speed, the balance of forces is reached. Along the aerodynamic axis, this balance can be expressed as :

$$(1) \quad \text{Thrust } \cos\alpha = \text{Drag} + \text{Weight } \sin\gamma$$

¹ In order to simplify, the thrust vector is represented parallel to the aircraft longitudinal axis.

The balance along the vertical axis, becomes :

$$(2) \quad \boxed{\text{Lift} = \text{Weight} \cos \gamma}$$

1.2.1. Climb Gradient (γ)

The climb gradient (γ) and the angle of attack (α) are usually small enough so that :

$$\begin{aligned} \sin \gamma &\approx \tan \gamma \approx \gamma \text{ (in radian)} \\ \cos \gamma &\approx 1 \text{ and } \cos \alpha \approx 1 \end{aligned}$$

As a result:

$$(3) \quad \boxed{\text{Thrust} = \text{Drag} + \text{Weight} \gamma}$$

$$(4) \quad \boxed{\text{Lift} = \text{Weight}}$$

From equation (3), Thrust - Drag = Weight γ . Then:

$$(5) \quad \boxed{\gamma_{\text{rad}} = \frac{\text{Thrust} - \text{Drag}}{\text{Weight}}}$$

$$(4)+(5) \quad \boxed{\gamma_{\text{rad}} = \frac{\text{Thrust}}{\text{Weight}} - \frac{\text{Drag}}{\text{Lift}}}$$

By introducing L/D (the Lift-to-Drag ratio), the climb angle becomes:

$$(6) \quad \boxed{\gamma_{\text{rad}} = \frac{\text{Thrust}}{\text{Weight}} - \frac{1}{L/D}}$$

Which gives, in percent:

$$(7) \quad \boxed{\gamma(\%) = 100 \cdot \left(\frac{\text{Thrust}}{\text{Weight}} - \frac{1}{L/D} \right)}$$

Conclusion: At a given weight and engine rating, the **climb gradient is maximum** when **(Thrust – Drag) is maximum** (i.e. when the **drag is minimum** or when the **lift-to-drag ratio is maximum**). The best lift-to-drag ratio speed is called **Green Dot** (or Drift-down) speed. In case of an engine failure, flying at green dot speed permits

maximizing the aircraft's aerodynamic efficiency and compensating for the power loss.

1.2.2. Rate of Climb (RC)

The Rate of Climb (RC) corresponds to the aircraft's vertical speed. As a consequence:

$$(8) \quad \boxed{RC = TAS \sin\gamma \approx TAS \gamma} \quad (\sin\gamma \approx \gamma_{rad} \text{ as } \gamma \text{ is small})$$

From equation (5), $\gamma = \frac{\text{Thrust} - \text{Drag}}{\text{Weight}}$. Therefore:

$$(9) \quad \boxed{RC = TAS \cdot \frac{\text{Thrust} - \text{Drag}}{\text{Weight}}}$$

Conclusion: At a given aircraft weight, the rate of climb is maximum when $TAS \times (\text{Thrust} - \text{Drag})$ is maximum. In terms of power¹, the **rate of climb is maximum** when **($P_{\text{thrust}} - P_{\text{drag}}$) is maximum**.

1.2.3. Speed Polar

The following Figure (G2) illustrates both the thrust and the drag forces versus the True Air Speed.

To fly at a constant level and speed, the thrust must balance the drag. As a result, **drag** can be considered as the **thrust required** to maintain a constant flight level and a constant speed. Climb is only possible when the available thrust is higher than the required thrust (excess of thrust).

The above equations indicate that, for a given weight:

- The climb angle (γ) is proportional to the difference between the available thrust and the required thrust.
- The rate of climb (RC) is proportional to the difference between the available power and the required power. Moreover, as $RC = TAS \gamma$, the maximum rate of climb is obtained for a TAS higher than green dot (when $dRC/dTAS = 0$).

¹ The force power (P_{force}) represents the force multiplied by the speed (TAS). The unit is watt (W).

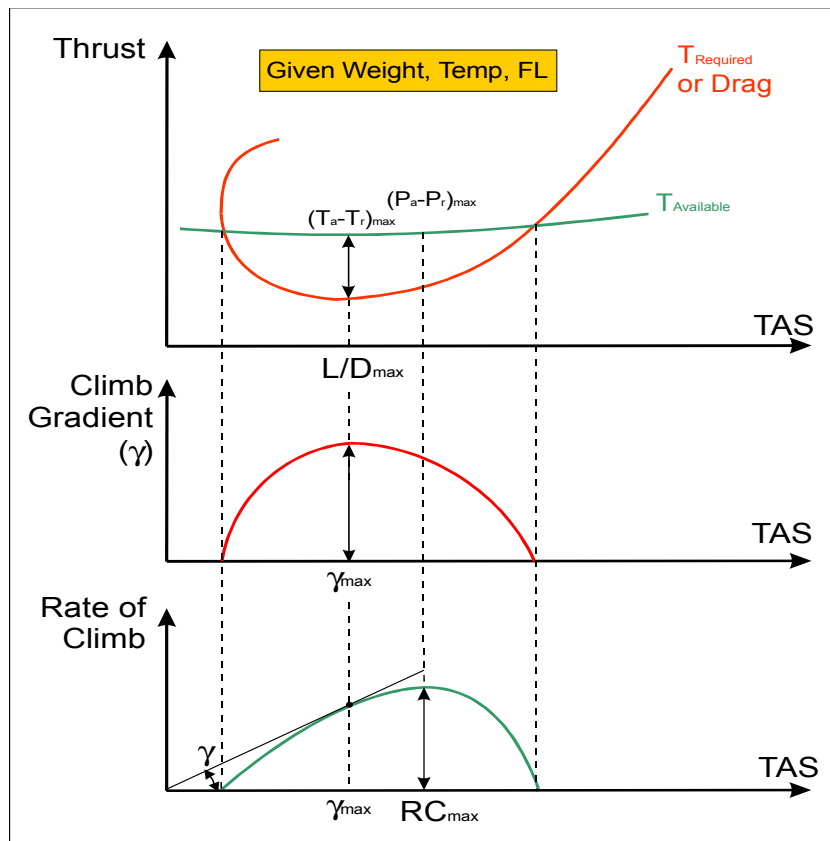

Figure G2: Thrust Curves and Speed Polar

It can be observed that it is not beneficial to climb at a speed lower than green dot, as it would require a longer distance and time to reach a given flight level.

1.3. Influencing Parameters

1.3.1. Altitude Effect

Due to air density reduction when pressure altitude increases, climb thrust and drag decrease. But, since the drag force decreases at a lower rate than the available thrust, the difference between thrust and drag decreases. Therefore, the climb gradient and the rate of climb decrease with pressure altitude, due to a lower excess of thrust.

$PA \nearrow \Rightarrow \begin{matrix} \text{climb gradient} \searrow \\ \text{rate of climb} \searrow \end{matrix}$

1.3.2. Temperature Effect

As temperature increases, thrust decreases due to a lower air density. As a result, the effect is the same as for altitude.

$$\text{Temperature} \nearrow \Rightarrow \begin{matrix} \text{climb gradient} \searrow \\ \text{rate of climb} \searrow \end{matrix}$$

1.3.3. Weight Effect

As seen in the previous section:

- (5) $\Rightarrow \gamma_{\text{rad}} = \frac{\text{Thrust} - \text{Drag}}{\text{Weight}}$

- (9) $\Rightarrow \text{RC} = \text{TAS} \cdot \frac{\text{Thrust} - \text{Drag}}{\text{Weight}}$

Therefore, at a given engine rating, altitude, and climb speed (TAS), any increase in weight leads to a decrease in the climb gradient and rate of climb.

$$\text{Weight} \nearrow \Rightarrow \begin{matrix} \text{climb gradient} \searrow \\ \text{rate of climb} \searrow \end{matrix}$$

1.3.4. Wind Effect

A constant wind component has no influence on the rate of climb, but changes the flight path.

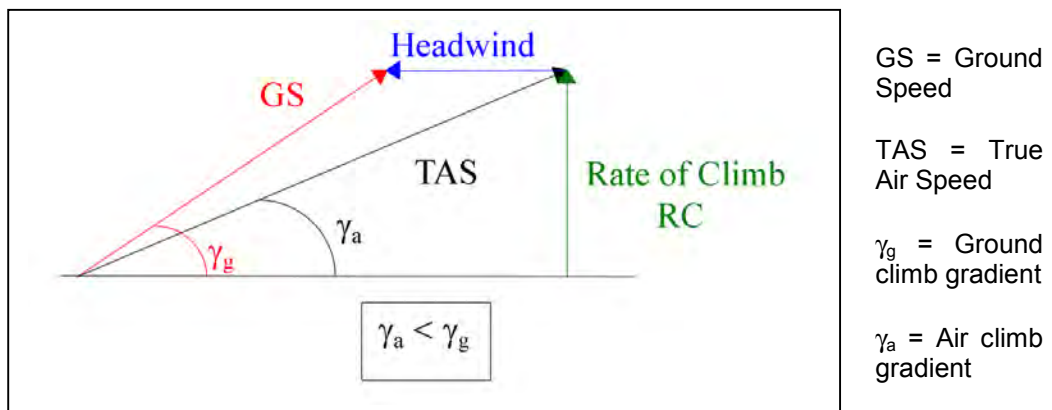
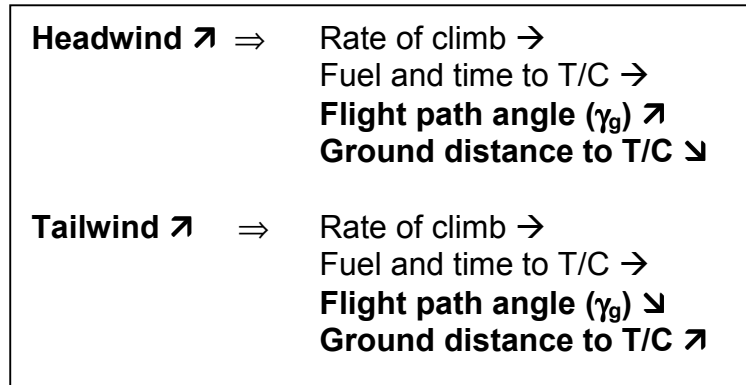

Figure G3: Headwind Component in Climb

As shown in Figure G3, the air climb gradient remains unchanged, whatever the wind component. So, the **fuel and time** to the Top Of Climb (T/C) remain **unchanged**.



2. CLIMB IN OPERATION

2.1. Climb Management

2.1.1. Thrust Setting

The standard climb rating is called “**Maximum Climb Thrust**”. At the **reduction altitude**, pilots have to reduce thrust from takeoff power to climb power by setting the thrust throttles to the climb (CL) gate (Figure G4). This must be done prior to a maximum time of 5 minutes after brake release.

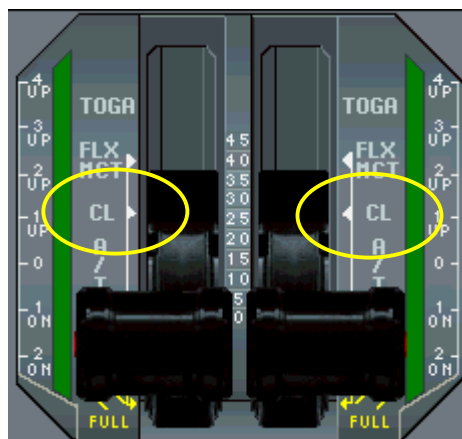

Figure G4: Thrust Throttle Positions

2.1.2. Energy Sharing

Aircraft energy is provided by the engines. To fly, an aircraft needs:

- Kinetic energy : Energy necessary to maintain speed and accelerate.
- Potential energy : Energy necessary to maintain altitude and climb.

The sum of the kinetic energy and the potential energy cannot exceed the total aircraft energy. Consequently, the total energy has to be shared between the need for speed and the need for altitude.

The FMGS manages this **energy sharing** during the climb (70% for speed, 30% for altitude). As a result, when:

- TAS increases: The climb gradient and the rate of climb decrease, as potential energy is converted into kinetic energy.
- TAS decreases: The climb gradient and rate of climb increase, as kinetic energy is converted into potential energy.

2.1.3. Climb Ceiling

The climb could continue until leveling off (i.e. when the rate of climb is close to zero). Nevertheless, as it would be both time and fuel consuming to reach the desired flight level, so the FMGS limits the climb to a maximum altitude. This maximum altitude is generally obtained when the rate of climb is equal to **300 feet per minute**.

2.2. Climb Speeds

2.2.1. Climb at Given IAS/MACH Law

A climb is generally operated at a constant Indicated Air Speed (IAS) and Mach Number. For instance, a standard climb profile for the A320 family is:

250 kt / 300 kt / M0.78

The climb phase is, therefore, divided into 3 phases (Figure G5):

- **Below 10,000 feet: Climb at constant IAS = 250 knots.** The speed is limited by Air Traffic Control (ATC) laws.
- **Above 10,000 feet: Climb at constant IAS = 300 knots** (limited to M0.78). At 10,000 feet, the aircraft accelerates to a more optimum climb speed (300 knots), which is maintained as long as the mach number remains under 0.78.
- **Above the crossover altitude: Climb at constant Mach = M0.78.** The crossover altitude is the altitude where 300 knots IAS is equal to M0.78. Above this altitude, a constant ratio between the TAS and the sound velocity must be maintained to avoid high speed buffeting.

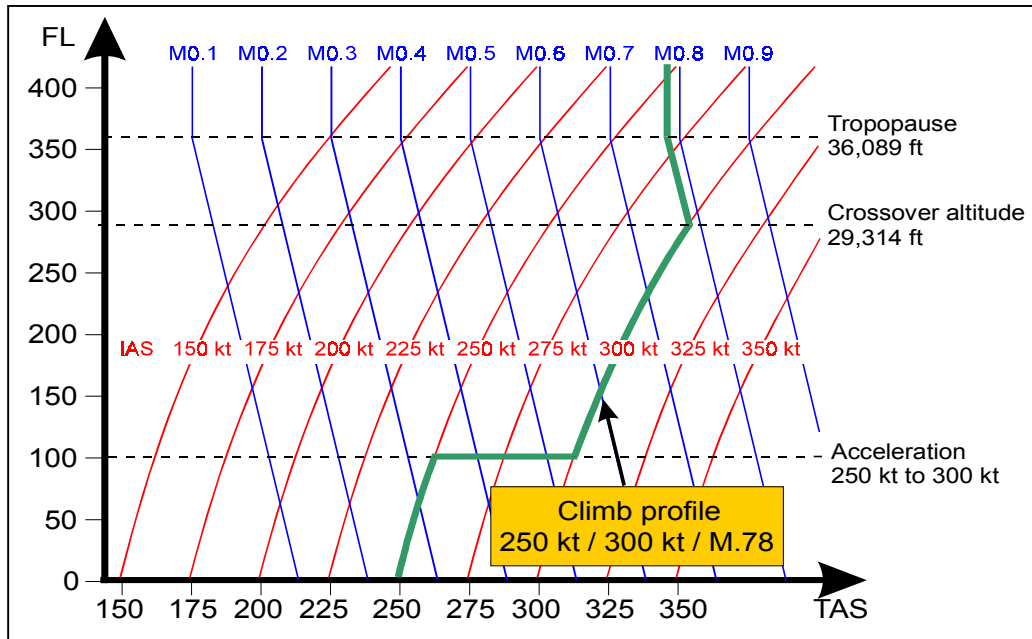

Figure G5: Climb Profile at given IAS/MACH Law

2.2.2. Climb at Maximum Gradient

The climb gradient at **green dot speed** is at its maximum. Climbing at green dot speed enables a given altitude to be achieved over the **shortest distance**.

Green dot speed is computed by the Flight Management System based on aircraft weight, and is **indicated** on the Primary Flight Display (PFD) as soon as the aircraft is in clean configuration. This speed can, consequently, be easily flown in manual mode. Green dot is the target speed, in case of an engine failure after takeoff.

2.2.3. Climb at Maximum Rate

Climbing at the maximum rate of climb speed enables a given altitude to be reached in the **shortest time**.

The **maximum rate of climb speed** is **not indicated** on the PFD. Nevertheless, a climb at maximum rate can be carried out in managed mode (refer to "Climb at minimum cost").

2.2.4. Climb at Minimum Cost

As seen in the "Cruise" chapter, the cost index aims at lowering direct operating costs. As a result, for a given cost index, an **optimum climb speed** (IAS_{ECON}) and an **optimum climb mach number** ($Mach_{ECON}$) are calculated by the FMGS as a function of the aircraft's weight. The climb is then carried out in managed mode, based on the following IAS/Mach law:

250 kt / IAS_{ECON} / Mach_{ECON}

To minimize overall fuel consumption during flight, a low cost index must be used. As the climb phase is fuel consuming, it is advantageous to minimize climb duration. This is achieved at the maximum rate of climb speed.

CI = 0 ⇒ IAS_{ECON} = Maximum rate of climb speed

On the other hand, a higher cost index provides a higher climb speed, thus lowering the rate of climb. But the distance covered during the climb is longer, so the cruise phase and total flight time are reduced. The maximum climb speed is generally limited to VMO - 10 knots.

CI = CI_{max} ⇒ IAS_{ECON} = VMO - 10 kt

2.3. FCOM Climb Table

A319/320/321 <small>FLIGHT CREW OPERATING MANUAL</small>	IN FLIGHT PERFORMANCE CLIMB	3.05.10	P 3
		SEQ 120	REV 25

CLIMB - 250KT/300KT/M.78								
MAX. CLIMB THRUST	ISA				FROM BRAKE RELEASE			
	CG=33.0%				TIME (MIN)	FUEL (KG)		
NORMAL AIR CONDITIONING					DISTANCE (NM)	TAS (KT)		
ANTI-ICING OFF								
FL	WEIGHT AT BRAKE RELEASE (1000KG)							
	66	68	70	72	74	76	78	
390								
370	24 1748	25 1851	27 1966	29 2096				
	152 385	163 387	175 389	190 391				
350	21 1619	22 1703	24 1794	25 1892	26 2000	28 2121	30 2258	
	132 377	140 378	149 380	158 381	169 383	182 385	196 388	
330	19 1515	20 1589	21 1668	22 1751	23 1840	25 1935	26 2040	
	117 369	124 370	131 371	138 373	146 374	155 376	165 378	
310	17 1419	18 1486	19 1566	20 1629	21 1706	22 1788	23 1876	
	104 361	110 362	115 363	121 364	128 365	135 366	142 368	
290	16 1322	16 1382	17 1444	18 1510	19 1578	20 1649	21 1725	
	92 350	96 351	101 352	106 353	111 354	117 355	123 356	
270	14 1206	14 1259	15 1313	16 1370	16 1429	17 1490	18 1555	
	78 337	81 337	85 338	89 339	93 340	97 341	102 342	
250	12 1103	13 1150	13 1198	14 1248	14 1300	15 1354	16 1410	
	66 324	69 324	72 325	75 326	79 326	82 327	86 328	
240	12 1055	12 1099	13 1145	13 1192	14 1241	14 1292	15 1344	
	61 317	64 318	67 318	70 319	73 320	76 321	79 321	
220	10 964	11 1004	11 1045	12 1087	12 1130	12 1175	13 1222	
	52 304	54 305	57 306	59 306	62 307	64 308	67 308	
200	9 880	10 916	10 953	10 991	11 1030	11 1070	11 1111	
	45 292	46 292	48 293	50 294	52 294	54 295	57 296	
180	8 802	8 834	9 867	9 901	9 936	10 972	10 1009	
	38 280	40 280	41 281	43 281	45 282	46 283	48 283	
160	7 727	8 756	8 786	8 816	8 848	9 880	9 913	
	32 267	34 267	35 268	36 268	38 269	39 270	41 270	
140	6 654	7 680	7 707	7 734	7 762	8 791	8 821	
	27 253	28 254	29 254	30 255	32 255	33 256	34 257	
120	6 583	6 606	6 630	6 654	7 679	7 705	7 731	
	22 238	23 239	24 239	25 240	26 241	27 242	28 242	
100	4 466	5 485	5 504	5 523	5 543	5 563	5 584	
	16 211	16 212	17 213	18 213	18 214	19 215	20 216	
50	3 301	3 313	3 325	3 337	3 349	3 362	3 375	
	8 173	8 174	9 174	9 175	9 176	10 177	10 178	
15	2 186	2 193	2 200	2 207	2 215	2 222	2 230	
	4 122	4 122	4 123	4 124	4 125	4 126	4 127	
LOW AIR CONDITIONING	HIGH AIR CONDITIONING	ENGINE ANTI ICE ON			TOTAL ANTI ICE ON			
ΔFUEL = - 0.4 %	ΔFUEL = + 0.4 %	ΔFUEL = + 6 %			ΔFUEL = + 11 %			

H03C -04 A320-231 V2500 2110000005KG330 0 018590 0 0 2 1.0 500.0 300.0 1 03 FCOM-N0-03-05-10-003-000

Figure G6: A320 Climb Table Example



Assumptions:

Weight at brake release : 74 t
 Temperature : ISA
 Air conditioning : Normal
 Anti-ice : Off
 Center of Gravity : 33%
 Speed : 250 kt / 300 kt / M0.78

Results:

Climb to FL330 :

- Time : 23 min
- Distance : 146 NM
- Fuel consumed : 1,840 kg
- Mean TAS : 374 kt

2.4. Cabin Climb

As the cabin is pressurized, a cabin pressurization system adjusts cabin altitude to provide passengers with a comfortable flight.

During normal operations, the cabin altitude is limited to a maximum value, which depends on the aircraft type. The purpose of this is to limit differential pressure ΔP (between the inside and outside) to a maximum value. For instance:

- A320 family : Max cabin altitude = 8,000 feet , $\Delta P_{\max} = 556$ hPa (8.06 PSI)
- A340-200/300 : Max cabin altitude = 7,350 feet , $\Delta P_{\max} = 593$ hPa (8.6 PSI)

Cabin altitude varies according to a preprogrammed law, in order to reach the scheduled cabin altitude at the top of climb defined by the FMGS cruise FL. For fly-by-wire aircraft, the cabin rate of climb is limited to 1,000 feet per minute.

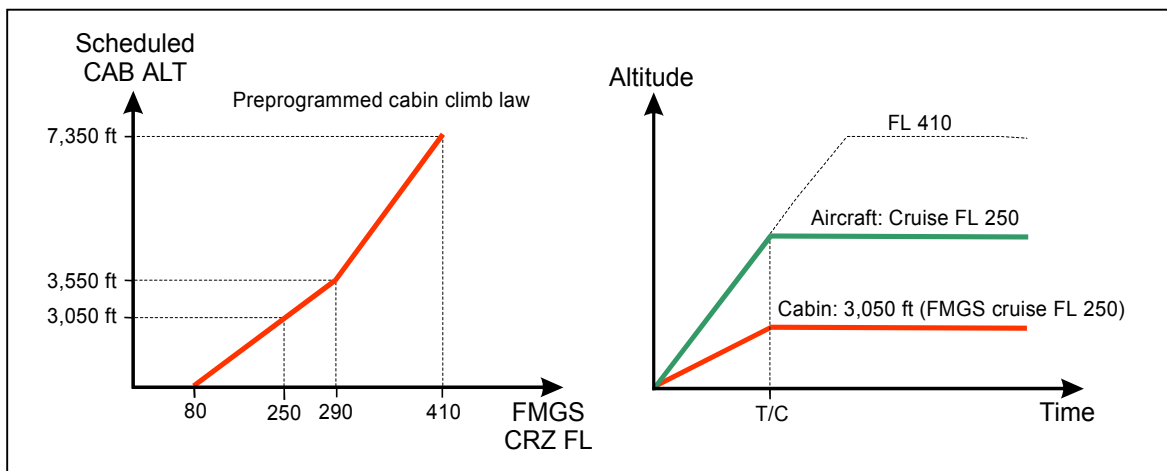

Figure G7: A340-200/300 Cabin Climb Law Example

In the above Figure (G7): When the FMGS cruise level is FL250, the cabin altitude remains at 3,050 feet during the cruise phase at this altitude.

H. DESCENT / HOLDING

1. FLIGHT MECHANICS

1.1. Definitions

The following Figure (H1) shows the different forces which applied on an aircraft in descent.

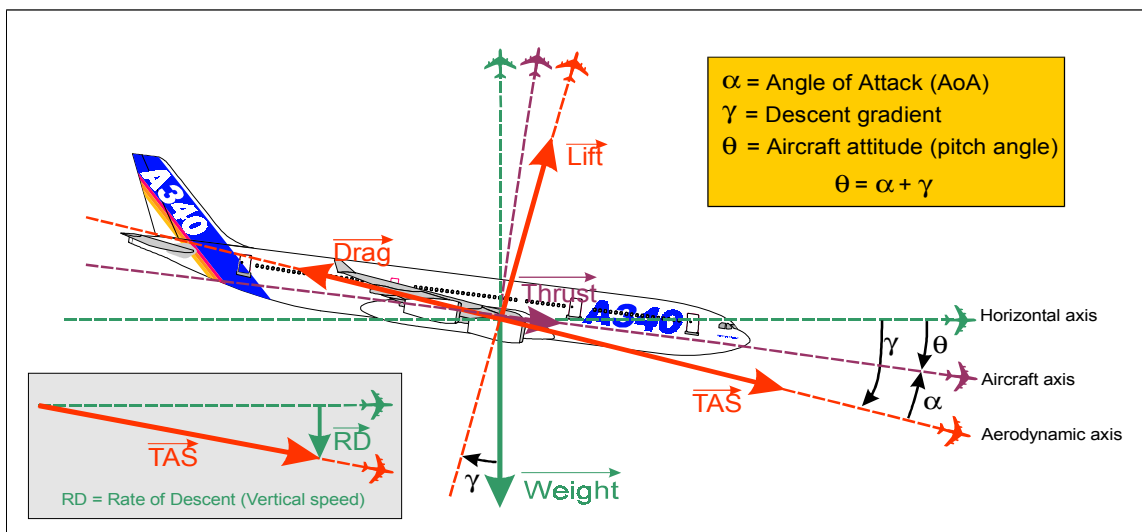

Figure H1: Balance of Forces in Descent¹

- For angle definitions, refer to the “Climb” chapter.
- The **rate of descent (RD)** represents the **vertical component of the aircraft’s speed**. It is negative and expressed in feet per minute.

1.2. Descent Equations

While climb is due to excess thrust, descent is, on the other hand, caused by a lack of thrust. Therefore, the descent gradient and the rate of descent, which depend on the difference (Thrust – Drag), are negative.

1.2.1. Descent Gradient (γ)

As seen in the “Climb” chapter, the gradient can be expressed as:

¹ In order to simplify, the thrust vector is represented parallel to the aircraft longitudinal axis.

$$(1) \quad \gamma_{\text{rad}} = \frac{\text{Thrust} - \text{Drag}}{\text{Weight}}$$

Descent is carried out at the Flight Idle thrust (i.e. at a thrust close to zero). Consequently:

$$(2) \quad \gamma_{\text{rad}} = -\frac{\text{Drag}}{\text{Weight}}$$

By introducing L/D (the Lift to Drag ratio), and as the weight value is close to the lift one (Lift = Weight.cos γ), the descent angle becomes:

$$(3) \quad \gamma_{\text{rad}} = -\frac{1}{L/D}$$

Which gives, in percent:

$$(4) \quad \gamma(\%) = -\frac{100}{L/D}$$

Conclusion: At a given weight, the magnitude of the descent **gradient is minimum** when **the drag is minimum**, or when the **lift-to-drag ratio is maximum**. The minimum descent angle speed is, therefore, **green dot** speed.

1.2.2. Rate of Descent (RD)

The Rate of Descent (RD) corresponds to the vertical component of the TAS.

$$(5) \quad \text{RD} = \text{TAS} \sin\gamma \approx \text{TAS} \gamma \quad (\sin\gamma \approx \gamma_{\text{rad}} \text{ as } \gamma \text{ is small})$$

Hence:

$$(6) \quad \text{RD} = -\text{TAS} \cdot \frac{\text{Drag}}{\text{Weight}} \quad \text{or} \quad \text{RD} = \frac{-\text{TAS}}{L/D} < 0$$

Conclusion: At a given aircraft weight, the **rate of descent is minimum**, when **TASxDrag is minimum**.

1.2.3. Speed Polar

The example below (Figure H2) illustrates both thrust and drag forces, as opposed to True Air Speed.

The above equations indicate that, for a given weight:

- The descent angle (γ) is proportional to the drag force, which is at its minimum at green dot speed.
- The rate of descent (RD) is proportional to the power of the drag force. As $RD = TAS \cdot \gamma$, the minimum rate of descent is obtained for a TAS lower than green dot (when $dRD/dTAS = 0$).

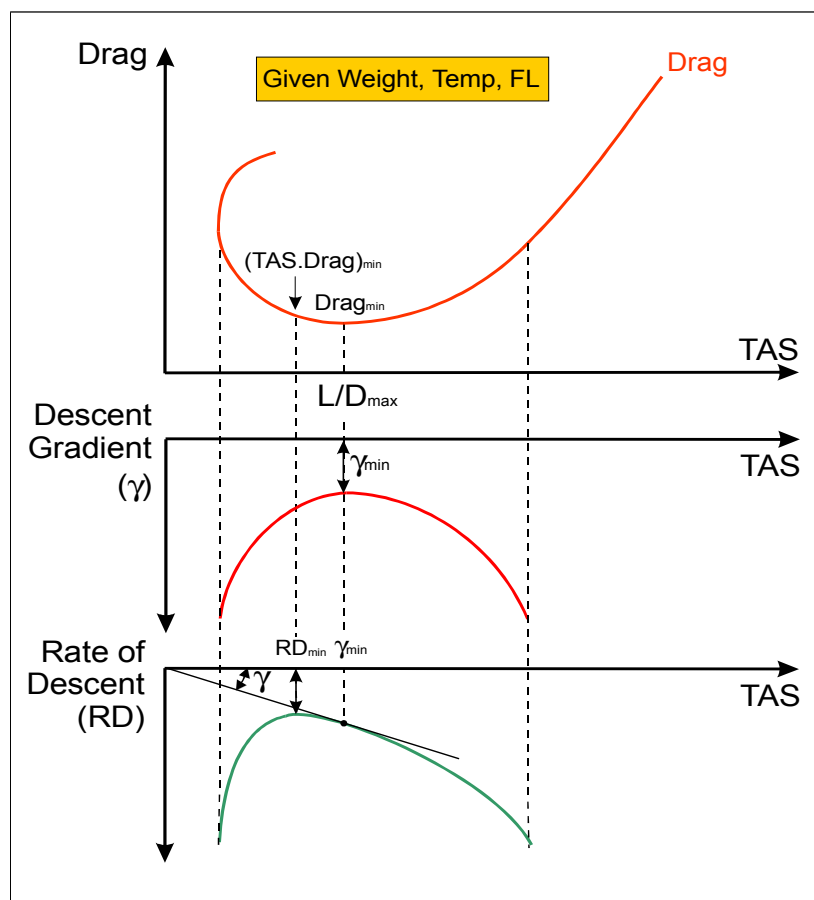

Figure H2: Drag Curve and Speed Polar

1.3. Influencing Parameters

1.3.1. Altitude Effect

During the descent phase, air density increases, so that, for a given aircraft weight and a given true air speed, the drag force also increases. As the descent

gradient and rate of descent are proportional to drag (Equations 2 and 6 above), an increase in their magnitude should be observed.

Nevertheless, as the descent is never performed at a given TAS, but at a given Mach or a given IAS, it is not possible to conclude. The following graph (Figure H3) represents the evolution of the descent gradient (γ) and rate of descent (RD), versus the altitude for a given descent profile M0.82 / 300 knots / 250 knots.

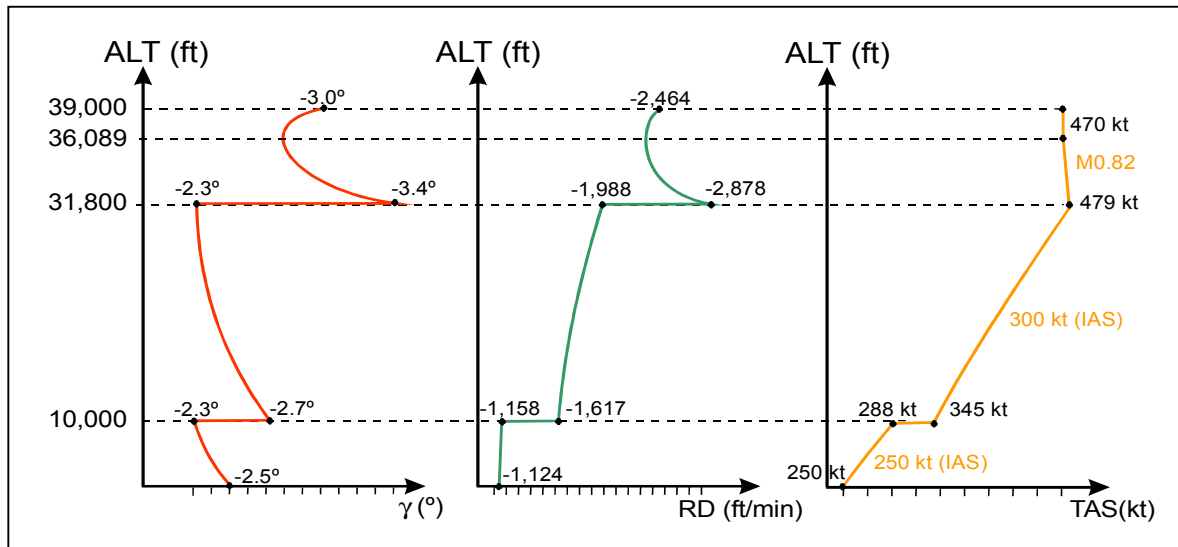

Figure H3: A330 example - Descent Gradient (γ) and Rate of Descent (RD) versus Altitude and TAS

Unlike the climb phase, it is difficult to assess descent parameters (gradient and rate), as they only depend on drag and not on thrust (which is assumed to be set to idle).

1.3.2. Temperature Effect

As for pressure altitude, the temperature effect is difficult to assess. Indeed, at a given altitude, an increase in temperature causes a reduction in air density. As a result, drag also decreases, and it could be convenient to conclude that the magnitude of the gradient and rate of descent are thus reduced.

Nevertheless, the TAS is not constant during the descent. For a given Mach or IAS, TAS increases with temperature, thus compensating for drag reduction. This is why descent parameter variations versus temperature are not really significant.

1.3.3. Weight Effect

Green dot speed (minimum gradient) is a function of weight. Figure H4 shows that, in the standard descent speed range (from green dot to VMO), the rate and gradient of descent magnitudes are reduced at higher weights.

Indeed, the balance of forces during descent indicates that:

$$\text{Lift} = \text{Weight} \cdot \cos\gamma = \frac{1}{2} \rho \cdot S \cdot \text{TAS}^2 \cdot C_L$$

At a given TAS, a higher weight means that a higher lift coefficient (C_L) is needed to maintain the balance of forces. This is achieved by increasing the angle of attack (α) and reducing the descent gradient (γ). As $RD = TAS \cdot \gamma$, the rate of descent is also reduced at higher weights.

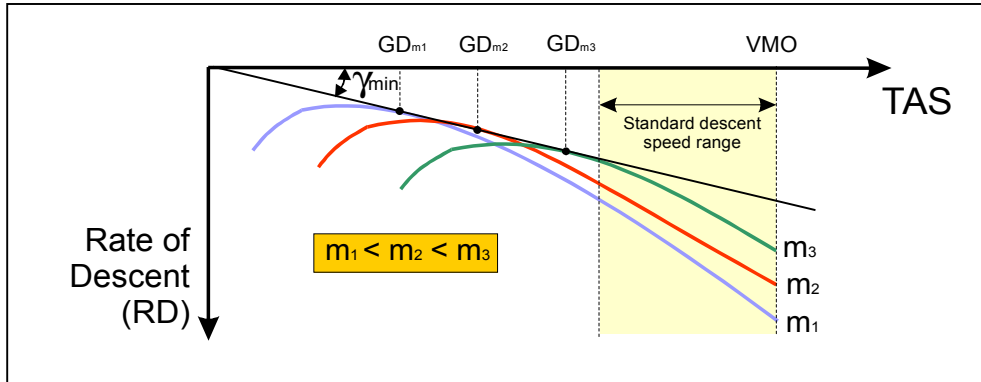

Figure H4: Gradient and Rate of Descent versus Speed and Weight

As a conclusion, in the standard descent speed range:

Weight ↗	⇒	descent gradient ↘
		rate of descent ↘

1.3.4. Wind Effect

As shown in Figure H5 below, the air descent gradient (γ_a) remains unchanged, whatever the wind component. So, the **fuel and time** necessary to descend from the Top Of Descent (T/D) to the final level remain **unchanged**.

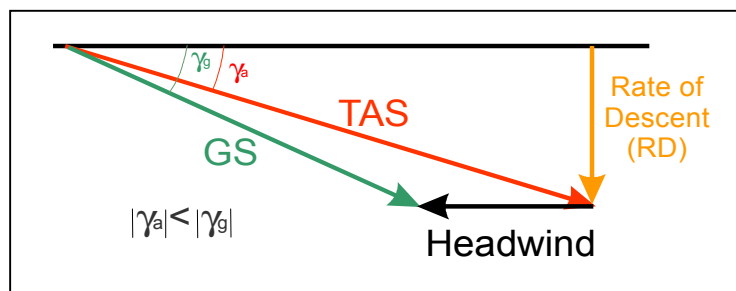
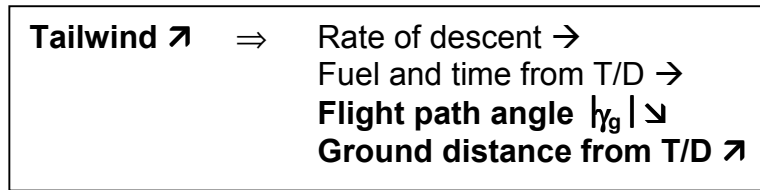

Figure H5: Headwind Effect on Descent Flight Path

Headwind ↗	⇒	Rate of descent →
		Fuel and time from T/D →
		Flight path angle γ_g ↗
		Ground distance from T/D ↘



2. DESCENT IN OPERATION

2.1. Thrust Setting

The standard engine rating for descent is “**Flight Idle Thrust**”. For fly-by-wire aircraft, the thrust throttle position doesn’t change when autothrust is engaged. The throttles remain on the “CL” (climb) gate for the entire flight (Figure H6). The engine-monitoring computer, or FADEC (Full Authority Digital Engine Control), adjusts the thrust level to the required value.

In case of an altitude constraint or a repressurization segment (see “Cabin Descent”), the aircraft’s vertical speed may have to be limited during descent. This is achieved at a thrust called “**Adapted Thrust**”. The adapted thrust may vary between flight idle thrust and maximum cruise thrust. It is delivered by the engines, when autothrust is engaged, as soon as the aircraft descent speed plus one of the two descent parameters (gradient or rate) have to be maintained at fixed values.

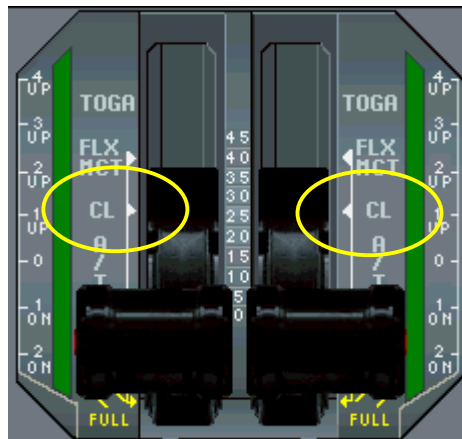

Figure H6: Thrust Throttle Position During Descent

2.2. Descent Speeds

2.2.1. Descent at Given MACH/IAS Law

A descent is generally operated at a constant Mach Number and Indicated Air Speed (IAS). For instance, a standard descent profile for the A320 family is:

M0.78 / 300 kt / 250 kt

TAS variations during descent are illustrated in Figure H7. For more details, refer to the “Climb” chapter.

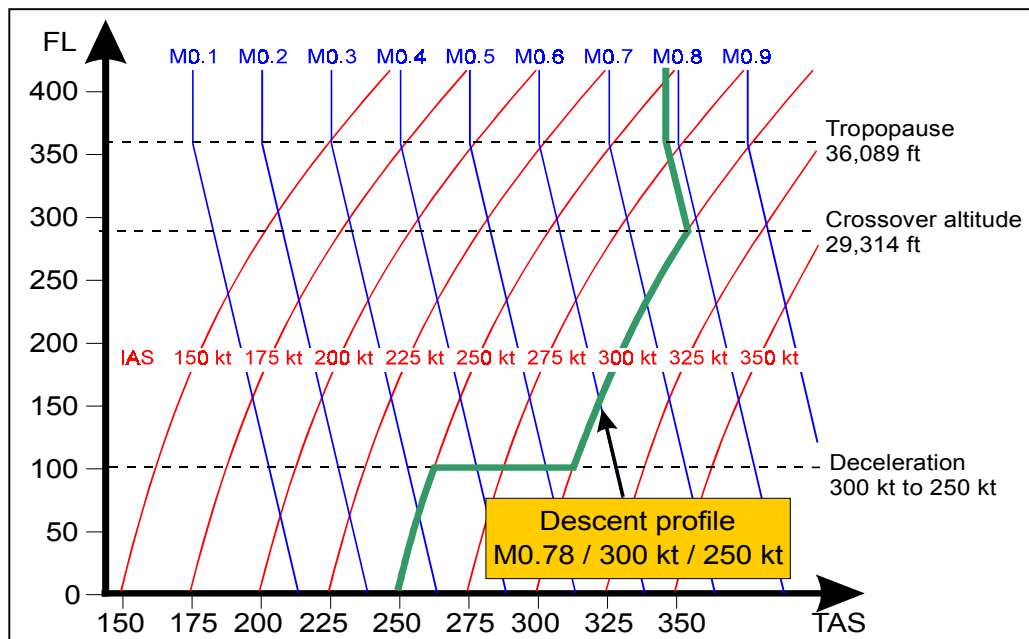

Figure H7: Descent Profile at Given MACH/IAS Law

2.2.2. Descent at Minimum Gradient (Drift Down)

The descent gradient at **green dot speed** is at its minimum. Descending at green dot speed enables the **highest possible altitude** to be maintained over the **longest distance**.

A green dot speed descent is of no interest in normal operations, as it requires a too much time. On the other hand, it is of great interest in case of an **engine failure** during cruise over a mountainous area, since it offers more escape solutions than any other speed. A green dot speed descent with one engine inoperative is called a **drift down procedure** (refer to the “En route Limitations” chapter).

2.2.3. Descent at Minimum Rate

The minimum rate of descent speed is lower than green dot. As a result, a descent at minimum rate is of no interest in operations, compared to a descent at green dot. Indeed, the time needed to reach a given altitude is longer than at green dot, whereas the distance covered is shorter. For this reason, and as a general rule, **it is not beneficial to descend at a speed lower than green dot**.

2.2.4. Descent at Minimum Cost

The cost index aims at lowering direct operating costs for a given flight. For given cost index, an **optimum descent Mach** ($Mach_{ECON}$) and an **optimum descent speed** (IAS_{ECON}) are calculated by the FMGS as a function of the aircraft’s weight.

The descent is then carried out in managed mode, based on the following MACH/IAS law:

$$\text{Mach}_{\text{ECON}} / \text{IAS}_{\text{ECON}} / 250 \text{ kt}$$

To **minimize** overall **fuel** consumption during flight, a **low cost index** must be used. As the descent phase is performed at idle thrust, it is advantageous to maximize its duration, from a fuel consumption standpoint. This is achieved at a low descent speed, which depends on the aircraft type (e.g. 250 knots for the A320 family). In any case, the descent speed must remain above green dot.

$$\text{CI} = 0 \Rightarrow \text{IAS}_{\text{ECON}} = \text{Minimum descent speed (depends on A/C type)}$$

On the other hand, a **high cost index** is required when the overall **flight time** needs to be **reduced** for cost reasons. In this case, the descent must be as fast as possible (i.e. at the maximum rate of descent speed). It is obtained at a speed, which is generally limited to VMO – 10 kt in normal operations .

$$\text{CI} = \text{CI}_{\text{max}} \Rightarrow \text{IAS}_{\text{ECON}} = \text{VMO} - 10 \text{ kt}$$

2.2.5. Emergency Descent

An emergency descent has to be carried out, in case of a cabin pressurization failure, the aim being to reach FL100 as soon as possible due to oxygen constraints. For this reason, **MMO/VMO** is the best speed schedule, as it enables the quickest possible rate of descent. This rate can even be increased by extending the **airbrakes**, if needed (refer to “En route Limitations” chapter).

2.3. FCOM Descent Table

Figure H8 shows an example of an A320 FCOM descent table:

A319/320/321		IN FLIGHT PERFORMANCE				3.05.30	P 2	
FLIGHT CREW OPERATING MANUAL		DESCENT				SEQ 110	REV 31	

R

DESCENT - M.78/300KT/250KT									
IDLE THRUST		ISA				MAXIMUM CABIN RATE OF DESCENT 350FT/MIN			
NORMAL AIR CONDITIONING		CG=33.0%							
ANTI-ICING OFF									
WEIGHT (1000KG)	45				65				IAS (KT)
	TIME (MIN)	FUEL (KG)	DIST. (NM)	N1	TIME (MIN)	FUEL (KG)	DIST. (NM)	N1	
390	16.1	181	102	73.0	17.0	125	103	IDLE	241
370	14.6	152	90	74.0	16.2	121	98	IDLE	252
350	12.9	115	77	75.9	15.6	118	93	IDLE	264
330	11.7	90	69	IDLE	14.9	114	88	IDLE	277
310	11.2	87	65	IDLE	14.3	110	83	IDLE	289
290	10.8	84	61	IDLE	13.7	107	79	IDLE	300
270	10.2	81	57	IDLE	12.9	103	73	IDLE	300
250	9.6	77	53	IDLE	12.1	98	67	IDLE	300
240	9.3	75	50	IDLE	11.7	95	64	IDLE	300
220	8.6	71	46	IDLE	10.9	90	59	IDLE	300
200	8.0	67	42	IDLE	10.1	84	53	IDLE	300
180	7.4	63	38	IDLE	9.3	79	48	IDLE	300
160	6.8	58	34	IDLE	8.5	73	43	IDLE	300
140	6.1	53	30	IDLE	7.6	66	37	IDLE	300
120	5.5	49	26	IDLE	6.8	60	32	IDLE	300
100	4.8	44	22	IDLE	5.9	53	27	IDLE	300
50	1.8	17	8	IDLE	2.2	21	9	IDLE	250
15	.0	0	0	IDLE	.0	0	0	IDLE	250

CORRECTIONS	LOW AIR CONDITIONING	ENGINE ANTI ICE ON	TOTAL ANTI ICE ON	PER 1° ABOVE ISA
TIME	—	+ 10 %	+ 10 %	—
FUEL	- 2 %	+ 60 %	+ 75 %	+ 0.60 %
DISTANCE	—	+ 10 %	+ 10 %	+ 0.60 %

Figure H8: A320 Descent Table Example

Assumptions:

Weight at T/D : 65 t
 Temperature : ISA
 Air conditioning : Normal
 Anti-ice : Off
 Center of Gravity : 33%
 Speed : M0.78 / 300 kt / 250 kt

Results:

Descent from FL370 to FL15

- Time : 16.2 min
- Distance : 98 NM
- Fuel consumed : 121 kg
- Initial thrust : Idle

2.4. Cabin Descent

The cabin pressure rate is optimized during descent, so that it reaches the landing field pressure + 0.1 psi just prior to landing.

Depending on the initial cabin and destination airport altitudes, the FMGS calculates the necessary cabin descent time. This time is obtained from the selected cabin rate of descent, defaulted to -350 feet per minute in the FMGS, but which can be modified up to a maximum of -750 feet per minute.

As soon as the cabin descent time is longer than the aircraft descent time, a **repressurization segment** is necessary, during which the aircraft vertical speed is limited to permit cabin repressurization (Figure H9).

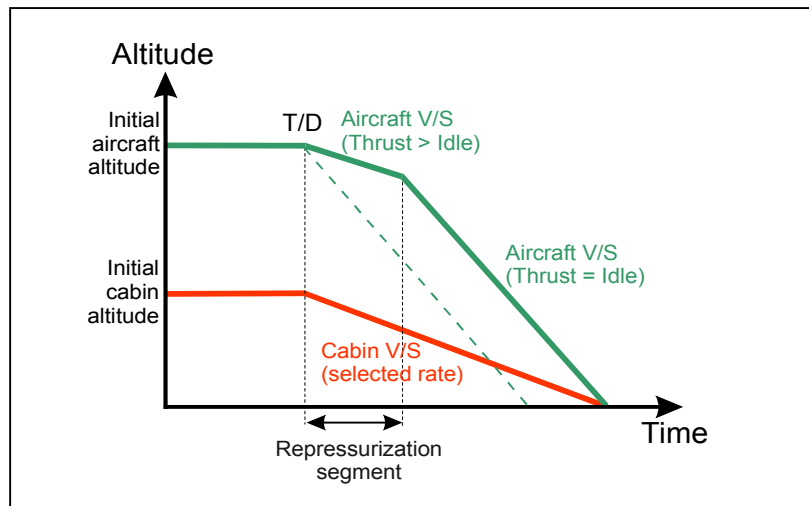

Figure H9: Cabin Repressurization Segment

The above A320 descent table (Figure H8) shows that to descend from FL390 at a weight of 45 tons, the N1 parameter must be maintained at 73%, from the start of the descent, in order to limit aircraft vertical speed.

Note that, in some particular cases (landing at high altitude airports), the cabin pressure at cruise level is higher than the pressure at the landing airport. Therefore, the cabin pressure has to decrease during descent, which means that the cabin's vertical speed is positive while the aircraft's vertical speed is negative.

3. HOLDING

3.1. Holding Speed

When holding is required, it is generally flown on a “**race track pattern**”, composed of two straight legs plus two 180 degree turns. As the aircraft is turning around, the distance covered is not the primary objective. On the contrary, the knowledge of the **maximum holding time** (maximum endurance) is a determining factor for any diversion decision. As a result, it is important, during holding, to try to **minimize fuel consumption versus time** as much as possible, or to simply **minimize fuel flow** (kg or lb per hour).

The minimum fuel consumption speed is somewhere between the minimum drag speed and the maximum lift-to-drag ratio (Green Dot) speed, which are quite close. As a result, in clean configuration, the standard holding speed is selected equal to **green dot**.

Holding patterns may be quite limiting around certain airports due to obstacle proximity. Therefore, green dot is sometimes too high, especially during turn phases where the bank angle can be too significant. As it is not possible to significantly reduce the speed below green dot in clean configuration, slats may be extended and a holding done in **CONF1** at “S” speed¹.

Note that green dot and S speeds are easy to fly in selected mode, as they are indicated on the Primary Flight Display (PFD), as a function of aircraft weight and configuration:

- In clean configuration: “Green Dot”
- In configuration 1: “S speed”

3.2. Holding in Operation

A holding pattern can be managed by the FMGS at a selected waypoint during flight. For that purpose, it must be entered on the MCDU Flight-Plan page. Holding pattern data may come from the navigation database, or may be defaulted to standard dimensions (which can be changed), when no pattern is available. In this case, the following default data is proposed (Figure H10):

- INB CRS : Inbound course of the holding pattern
- Turn : Direction of the turn (Right or Left).
- Time: Outbound leg of 1 minute below 14,000 feet, 1.5 minutes above.
- DIST: Distance calculated from the predicted TAS which, in turn, depends on the holding speed (speed for max endurance, ICAO speed limit, or constraint speed, whichever is lower).



H10: Holding Pattern Data

¹ S speed = Minimum slat retraction speed (from CONF1 to CONF CLEAN)

I. FUEL PLANNING AND MANAGEMENT

1. JAR - FUEL PLANNING AND MANAGEMENT

1.1. Fuel policy

The fuel quantity required for a safe trip along the planned route is calculated for each flight. Each operator has its own fuel policy. This policy is based on the loading of minimum regulatory fuel requirements (JAR-OPS 1).

“JAR-OPS 1.255

*An operator **must establish a fuel policy** for the purpose of flight planning and in-flight replanning to ensure that **every flight** carries sufficient fuel for the planned operation and reserves to cover deviations from the planned operation.”*

1.1.1. Standard Flight Planning

JAR-OPS 1.255 Subpart D + AMC OPS 1.255

Although fuel quantity varies in accordance with national regulations, the JAR-OPS requirements and the various national regulations are very similar.

The minimum fuel quantity (**Q**) calculated for flight planning is defined as:

$$Q = \text{taxifuel} + TF + CF + AF + FR + \text{Add} + XF$$

Where

- TF = **Trip Fuel**
- CF = **Contingency Fuel**
- AF = **Alternate Fuel**
- FR = **Final Reserve Fuel**
- Add = **Additional Fuel**
- XF = **Extra Fuel**

Figure I1 illustrates the different fuel quantities and associated flight phases of a typical trip.

The following operating conditions should be taken into account for each flight:

- Realistic airplane fuel consumption data.
- Anticipated weight.
- Expected weather conditions.
- Air traffic services' procedures and restrictions.

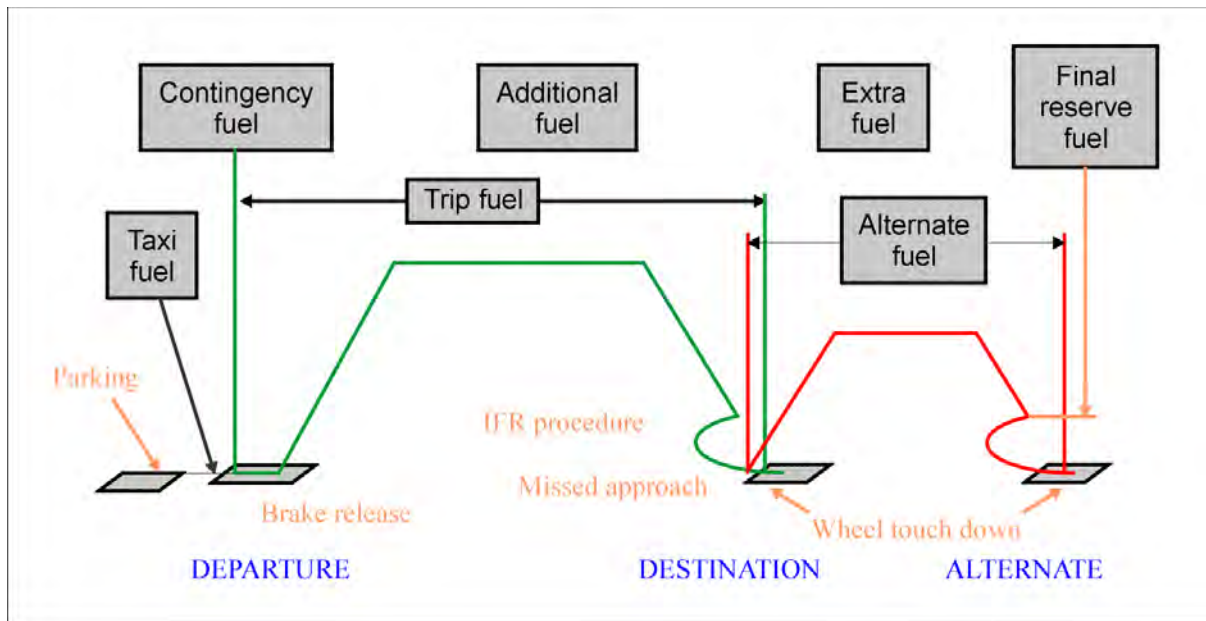

Figure 11: Representation of the Different Fuel Quantities

1.1.1.1. Taxi Fuel

“AMC OPS 1.255

Taxi fuel, which should not be less than the amount, expected to be used prior to take-off. Local conditions at the departure aerodrome and APU consumption should be taken into account.”

Taxi fuel is usually a fixed quantity for an average taxi duration.

For the A320 for example, it is equal to 140 kg (300 lb). This corresponds to a 12-minute average taxi fuel.

Based on statistics or evaluation, the taxi duration and taxi fuel may need to be adjusted.

1.1.1.2. Trip Fuel

The required fuel quantity from brake release at the departure airport to the landing touchdown at the destination airport, is referred to as trip fuel. This quantity takes into account the necessary fuel for:

- Takeoff
- Climb to cruise level
- Flight from the end of climb to the beginning of descent, including any step climb/descent
- Flight from the beginning of descent to the beginning of approach,
- Approach
- Landing at the destination airport

1.1.1.3. Contingency Fuel

Contingency fuel is the greatest of two quantities:

- The fuel necessary to fly for 5 minutes at 1500 feet above the destination airport at holding speed in ISA conditions
- One of the following quantities:
 - **5% of trip fuel**,
 - With airworthiness approval, **3% of trip fuel** with an available en route alternate airport*,
 - With airworthiness approval, the necessary fuel to fly for **15 minutes** at 1500 feet above the destination airport, at holding speed, in ISA conditions; the Operator must have a program to monitor fuel consumption on each individual route / aircraft combination and must use the program to statistically calculate contingency fuel
 - The required fuel to fly for **20 minutes**, based upon trip fuel consumption, provided the operator has a fuel consumption monitoring program for individual airplanes and uses the resulting data for fuel calculation.

* Appendix 1 to AMC-OPS 1.255 explains how to reduce contingency fuel from 5% to 3%:

“AMC-OPS 1.255

If an en-route alternate is available within a circle having a radius equal to 20% of the total flight plan distance, the centre of which lies on the planned route at a distance from the destination of 25% of the total flight plan distance, or at 20% of the total flight plan distance plus 50nm, whichever is greater”

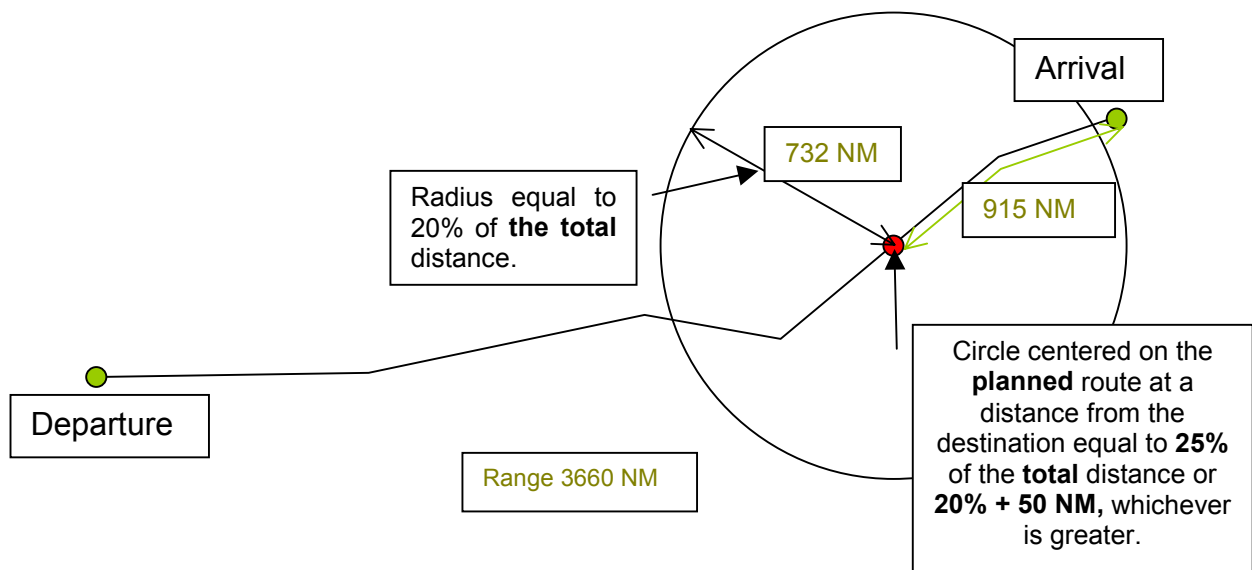

1.1.1.4. Alternate Fuel

Alternate fuel takes into account the necessary fuel for:

- Missed approach at the destination airport
- Climb from the missed approach altitude to the cruise level
- Flight from the end of climb to the beginning of descent
- Flight from the beginning of descent to the beginning of the approach
- Approach
- Landing at the alternate airport
- When two alternate airports are required*, alternate fuel should be sufficient to proceed to the alternate which requires the greater amount of fuel.

*Two alternate airports are required, when:

“JAR-OPS 1.295

(1) The appropriate weather reports or forecasts for the destination, or any combination thereof, indicate that during a period commencing 1 hour before and ending 1 hour after the estimated time of arrival, the weather conditions will be below the applicable planning minima; or

(2) No meteorological information is available.”

1.1.1.5. Final Reserve Fuel

The final reserve fuel is the minimum fuel required to fly for **30 minutes** at 1,500 feet above the alternate airport or destination airport, if an alternate is not required, at holding speed in ISA conditions.

1.1.1.6. Additional Fuel

“AMC OPS 1.255

1.6 [...] the minimum additional fuel which should permit:

a. Holding for 15 minutes at 1500 ft (450 m) above aerodrome elevation in standard conditions, when a flight is operated under IFR without a destination alternate, in accordance with JAR-OPS 1.295; and

b. Following the possible failure of a power unit or loss of pressurisation, based on the assumption that such a failure occurs at the most critical point along the route, the aeroplane to:

i. Descend as necessary and proceed to an adequate aerodrome; and

ii. Hold there for 15 minutes at 1500 ft (450 m) above aerodrome elevation in standard conditions; and

iii. Make an approach and landing, except that additional fuel is only required, if the minimum amount of fuel calculated in accordance with sub-paragraphs 1.2 to 1.5 above is not sufficient for such an event.”

1.1.1.7. Extra Fuel

Extra fuel is at the Captain's discretion.

1.1.2. Isolated Airport Procedure

JAR-OPS 1.255 Subpart D + AMC OPS 1.255

For such an airport, there is no destination alternate. The regulatory takeoff fuel quantity must include:

- Taxi fuel
- Trip fuel
- Contingency fuel, as calculated in the standard fuel policy
- Additional fuel: This quantity must be higher than the quantity necessary for a **two hour flight** at cruise rating above the destination airport; final reserve fuel is included in this amount
- Extra fuel, is at the Captain's discretion.

1.1.3. Unrequired Destination Alternate Airport

JAR-OPS 1.295 Subpart D

An alternate airport is not required, when all of the following conditions are met:

- Flight time does not exceed 6 hours from takeoff to landing
- At the destination airport, two separate runways¹ are available
- From one hour before to one hour after the Estimated Time of Arrival (ETA) a VMC (Visual Meteorological Condition) approach and landing can be made from the minimum altitude sector.

1.1.4. Decision Point Procedure

JAR-OPS 1.255 Subpart D + AMC OPS 1.255

This procedure permits aircraft to carry less contingency fuel than in the standard case.

Operators select a point called the decision point along the planned route (Figure I2). At this point, the pilot has two possibilities:

¹ Separate runways: Separate landing surfaces which do not overlay or cross such that if one of the runways is blocked, it will not prevent the plane type from operating on the other one, and each has a separate approach procedure based on a separate aid

- Reach a suitable proximate diversion airport, taking into account the maximum landing weight limitation.
- Continue the flight to the destination airport, when the remaining fuel is sufficient.

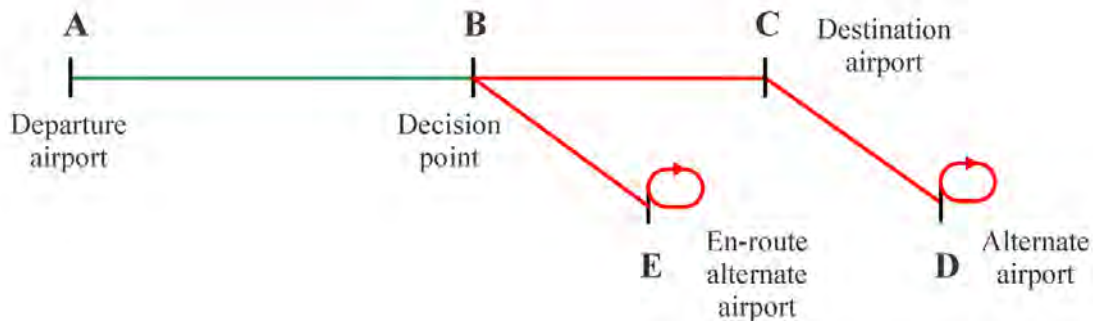

Figure I2: Decision Point Procedure

Using this procedure, the fuel required is the greatest of:

“AMC OPS 1.255

[F1:] sum of

- Taxi fuel;
- Trip fuel to the destination aerodrome, via the decision point;
- Contingency fuel equal to not less than 5% of the estimated fuel consumption from the decision point to the destination aerodrome;
- Alternate fuel, if a destination alternate is required;
- Final reserve fuel;
- Additional fuel; and
- Extra fuel if required by the commander; or,

[F2:] sum of

- Taxi fuel;
- The estimated fuel consumption from the departure aerodrome to a suitable en-route alternate, via the decision point;
- Contingency fuel equal to not less than 3% of the estimated fuel consumption from the departure aerodrome to the en-route alternate;
- Final reserve fuel;
- Additional fuel; and
- Extra fuel if required by the commander.”

Which gives:

$F1 = \text{taxi}_A + \text{trip}_{AC} + 5\% \text{ trip}_{BC} + \text{alternate}_{CD} + \text{holding}_D + \text{additional} + \text{extra}$ $F2 = \text{taxi}_A + \text{trip}_{AE} + 3\% \text{ trip}_{AE} + \text{holding}_E + \text{additional} + \text{extra}$

Comparing the **standard** fuel planning and the **decision point procedure** fuel planning, the **maximum contingency fuel reduction is 5% of the trip fuel between A and B.**

$$F1 = \text{taxi}_A + \text{trip}_{AC} + 5\% \text{ trip}_{BC} + \text{alternate}_{CD} + \text{holding}_D + \text{additional} + \text{extra}$$

$$\text{STD} = \text{taxi}_A + \text{trip}_{AC} + 5\% \text{ trip}_{AC} + \text{alternate}_{CD} + \text{holding}_D + \text{additional} + \text{extra}$$

1.1.5. Pre-Determined Point Procedure

JAR-OPS 1.255 Subpart D + AMC OPS 1.255

This procedure is similar to the Decision Point procedure, in case of an isolated destination airport.

In this case, operators define a pre-determined point (see Figure I3).

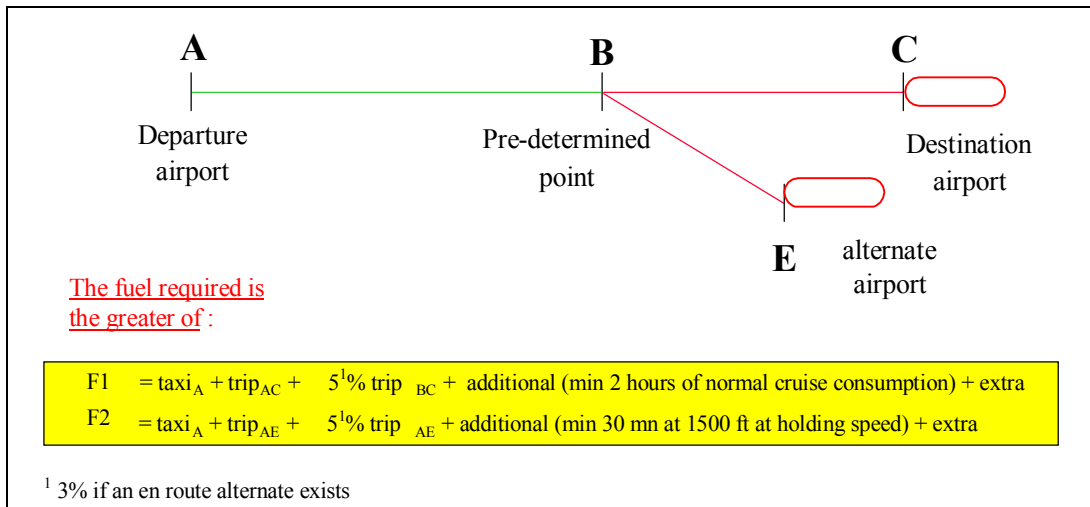

Figure I3: Pre-determined Point Procedure

1.1.6. ETOPS Procedure

JAR-OPS 1.255 Subpart D + AMC OPS 1.255
IL n° 20 - JAA Administrative guidance material

To determine the amount of fuel, an ETOPS¹ flight requires **another condition for additional fuel** (See Figure I4), to take into account the following critical scenarios:

- Pressurization failure at the critical point.
- Pressurization failure and engine failure at the critical point.

¹ For more information, refer to the “ Getting to Grips with ETOPS” brochure.

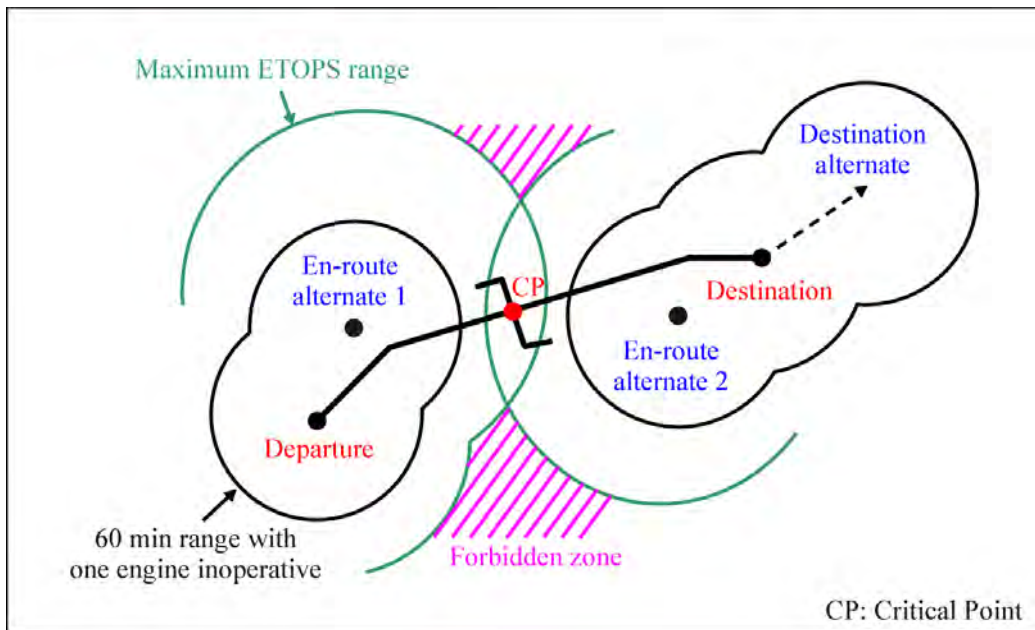

Figure I4: ETOPS Procedure

If one of these critical scenarios occurs, the aircraft must be able to follow a particular procedure (see Figure I5) :

- Descend to FL100
- Continue cruise
- Descend to 1,500 feet when approaching the diversion airport
- Hold for 15 minutes
- Make a missed approach
- Execute a normal second approach
- Land.

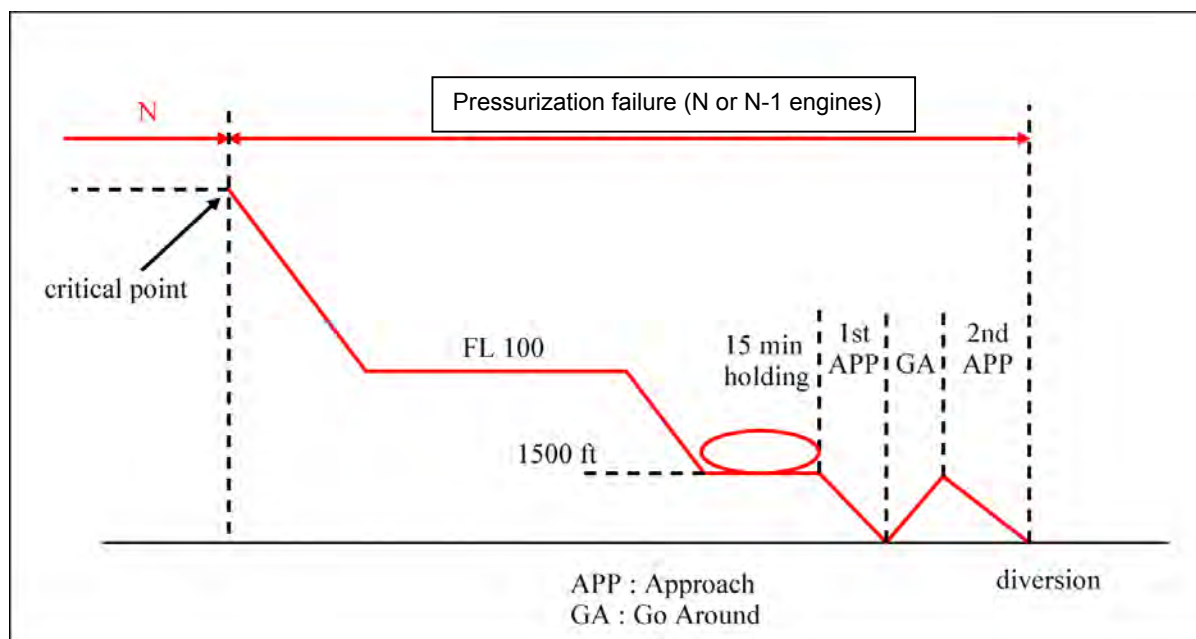

Figure I5: Critical Scenarios

For an ETOPS flight, the minimum onboard fuel quantity must be the greatest of the standard fuel planning and of the sum of the following quantities:

- Taxi fuel
- Trip fuel from departure to the critical point (with all engines operative)
- Trip fuel from the critical point to a suitable en route alternate airport, taking into account the critical scenarios
- Reserves:
 - 5% of trip fuel, to cover weather forecast errors
 - 5% of trip fuel or demonstrated performance factor to cover aircraft performance deterioration
 - A percentage of trip fuel to cover icing conditions when necessary (depending on aircraft type)
- APU consumption if needed
- Fuel for a 15-minute holding at 1,500 feet
- Fuel for a missed approach
- Fuel for a second approach and landing.

1.2. Fuel Management

1.2.1. Minimum Fuel at Landing Airport

JAR-OPS 1.375

The in-flight remaining fuel must be sufficient to proceed to an airport where a safe landing can be made, with the **final reserve fuel** still remaining **on landing**.

This regulation applies to the destination airport, the destination alternate airport, as well as to any en route alternate airport.

Note: The Captain shall declare an emergency when:

$$\text{Actual fuel on board} \leq \text{Final reserve}$$

1.2.2. Minimum Fuel at Destination Airport

1.2.2.1. With a Destination Alternate Airport

JAR-OPS 1.375 - Appendix 1

The pilot must arrive over the destination with enough fuel to ensure flight safety.

The following illustrates a standard arrival profile.

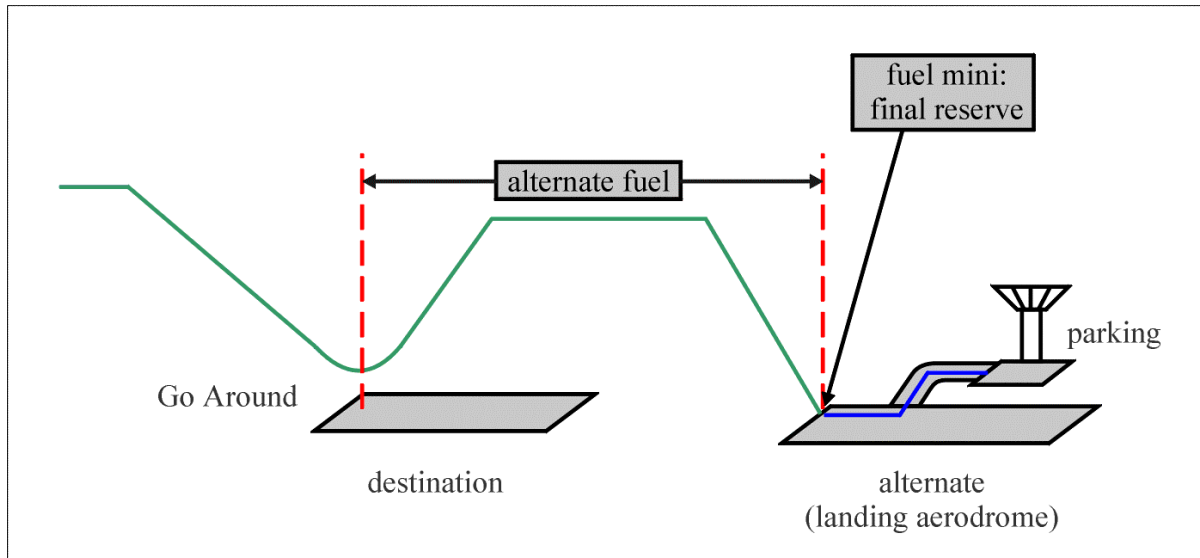

Figure 16: Minimum Fuel at Destination

The minimum regulatory fuel above the destination threshold shall be the minimum amount of fuel enabling the aircraft to reach the alternate airport. It is defined as follows:

<p>Minimum fuel at destination (with alternate)</p> <p>=</p> <p>Alternate fuel + Final reserve fuel</p>

If the expected remaining fuel on arrival at the destination airport is less than the alternate fuel plus the final reserve, the Captain must consider the prevailing traffic and operational conditions at the destination airport, along the diversion route to the destination alternate airport, when deciding whether to go on to the destination, or to divert.

1.2.2.2. Without Destination Alternate Airport

In this case, the minimum fuel remaining on board at landing shall be the Final Reserve Fuel.

<p>Minimum fuel at destination (without alternate)</p> <p>=</p> <p>Final reserve (2 hours)</p>
--

1.2.2.3. Max Holding Time above Destination Airport

- Available Holding Fuel

Holding is possible, when the remaining fuel above the destination airport is more than the minimum fuel at destination, plus the fuel for approach.

Available fuel for holding on arrival = Remaining fuel at destination - (alternate fuel + final reserve + approach)

- Maximum Holding Time

From the available holding fuel and the holding hourly consumption, the holding time is obtained as follows:

$t = \frac{\text{Available fuel for holding}}{\text{Holding hourly consumption}}$

2. FAR - FUEL PLANNING AND MANAGEMENT

2.1. Different Types of Operations

Three cases have to be taken into account:

- **Domestic Operations**
 - Between any points within the 48 contiguous States of the United States or the District of Columbia; or
 - Operations solely within the 48 contiguous States of the United States or the District of Columbia; or
 - Operations entirely within any State, territory, or possession of the United States; or
 - When specifically authorized by the Administrator, operations between any point within the 48 contiguous States of the United States or the District of Columbia and any specifically authorized point located outside the 48 contiguous States of the United States or the District of Columbia.
- **Flag Operations**
 - Between any point within the State of Alaska or the State of Hawaii or any territory or possession of the United States and any point outside the State of Alaska or the State of Hawaii or any territory or possession of the United States, respectively; or
 - Between any point within the 48 contiguous States of the United States or the District of Columbia and any point outside the 48 contiguous States of the United States and the District of Columbia.
 - Between any point outside the U.S. and another point outside the U.S.
- **Supplemental Operations**
 - Operations for which the departure time, departure location, and arrival location are specifically negotiated with the customer or the customer's representative.
 - All-cargo operations.

2.2. Fuel Policy

The required fuel quantity for a safe trip along the planned route is calculated for each flight. Each operator has its own fuel policy. This policy is based on the loading of minimum regulatory fuel requirements (FAR 121).

2.2.1. Domestic Operations

FAR 121.639 Subpart U

“FAR 121.639

No person may dispatch or take off an airplane unless it has enough fuel--

(a) To fly to the airport to which it is dispatched

(b) Thereafter, to fly to and land at the most distant alternate airport (where required) for the airport to which dispatched; and

(c) Thereafter, to fly for 45 minutes at normal cruising fuel consumption.”

The minimum fuel quantity (**Q**) calculated for domestic operation is defined as:

$$Q = \text{taxifuel} + TF + AF + FR$$

Where:

- TF = Trip fuel
- AF = Alternate fuel
- FR = Final reserve fuel

Figure I7 illustrates the different fuel quantities and associated flight phases during a typical trip.

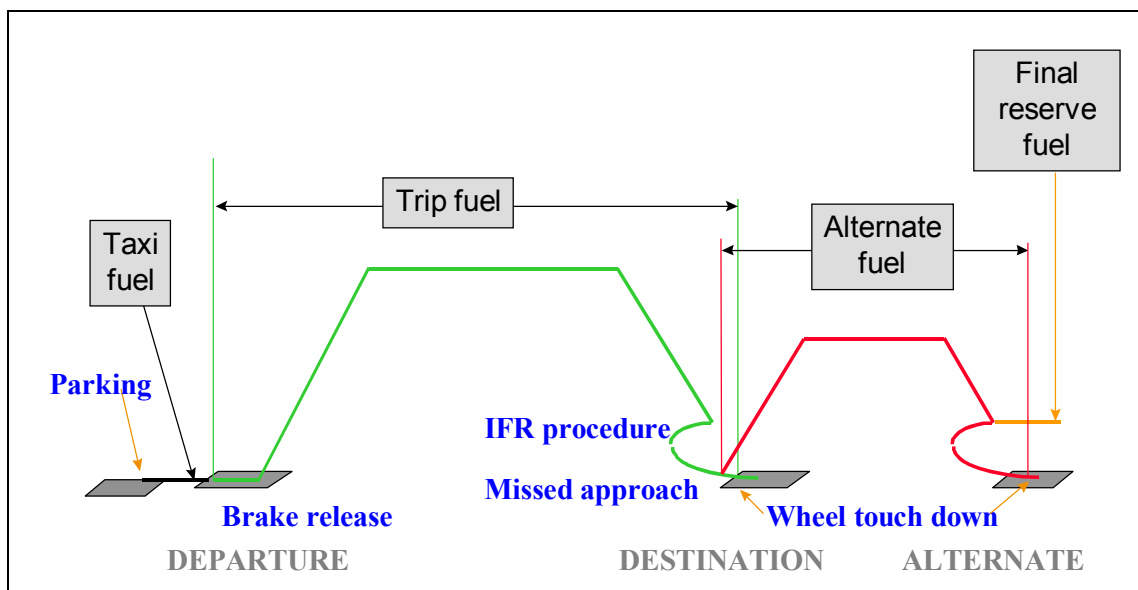

Figure I7: Fuel Quantities for Domestic Operation

2.2.1.1. Taxi Fuel

In order to determine this amount, local conditions at departure and APU consumption should be taken into account.

Taxi fuel is usually a fixed quantity for an average taxi duration.

For the A320 for example, it is equal to 140 kg (300 lb). This corresponds to a 12-minute average taxi fuel. Based on statistics or evaluation, the taxi duration and taxi fuel may need to be adjusted.

2.2.1.2. Trip Fuel

The required fuel quantity from brake release at the departure airport to the landing touchdown at the destination airport. This quantity takes into account the necessary fuel for:

- Takeoff
- Climb to cruise level
- Flight from the end of climb to the beginning of descent
- Flight from the beginning of descent to the beginning of approach
- Approach
- Landing at the destination airport
- Anticipated traffic delays.

Daily weather conditions must also be taken into account.

2.2.1.3. Alternate Fuel

Alternate fuel is the amount necessary to fly to the most distant alternate airport, and takes into account:

- Missed approach at the destination airport,
- Climb from the missed approach altitude to cruise level,
- Flight from the end of climb to the beginning of descent,
- Flight from the beginning of descent to the beginning of approach,
- Approach,
- Landing at the alternate airport.
- When two alternate airports are required*, alternate fuel should be sufficient to proceed to the alternate, which requires the greater amount of fuel.

* Two alternate airports are required, when:

“FAR 121.619

When the weather conditions forecast for the destination and first alternate airport are marginal at least one additional alternate must be designated.”

2.2.1.4. Final Reserve Fuel

The final reserve fuel is the minimum fuel required to fly for **45 minutes** at normal cruise consumption.

2.2.2. Flag and Supplemental Operations

FAR 121.645 Subpart U

“FAR 121.645

(b) Any certificate holder conducting flag or supplemental operations, [...] considering wind and other weather conditions expected, must have enough fuel--

- (1) To fly to and land at the airport to which it is released;*
- (2) After that, to fly for a period of **10 percent of the total time** required to fly from the airport of departure to, and land at, the airport to which it was released;*
- (3) After that, to fly to and land at the most distant alternate airport specified in the flight release, if an alternate is required; and*
- (4) After that, to fly for **30 minutes** at holding speed at 1,500 feet above the alternate airport (or the destination airport if no alternate is required) under standard temperature conditions.”*

The minimum fuel quantity (**Q**) calculated for flight planning is defined as:

$$Q = \text{taxifuel} + TF + CF + AF + FR + \text{Add}$$

Where:

- TF = **Trip fuel**
- CF = **Contingency fuel**
- AF = **Alternate fuel**
- FR = **Final reserve fuel**
- Add = **Additional fuel**

Figure I8 illustrates the different fuel quantities and associated flight phases of a typical trip.

The following operating conditions should be taken into account for each flight:

- Realistic airplane fuel consumption data
- Anticipated weight
- Expected weather conditions
- Air traffic services' procedures and restrictions.

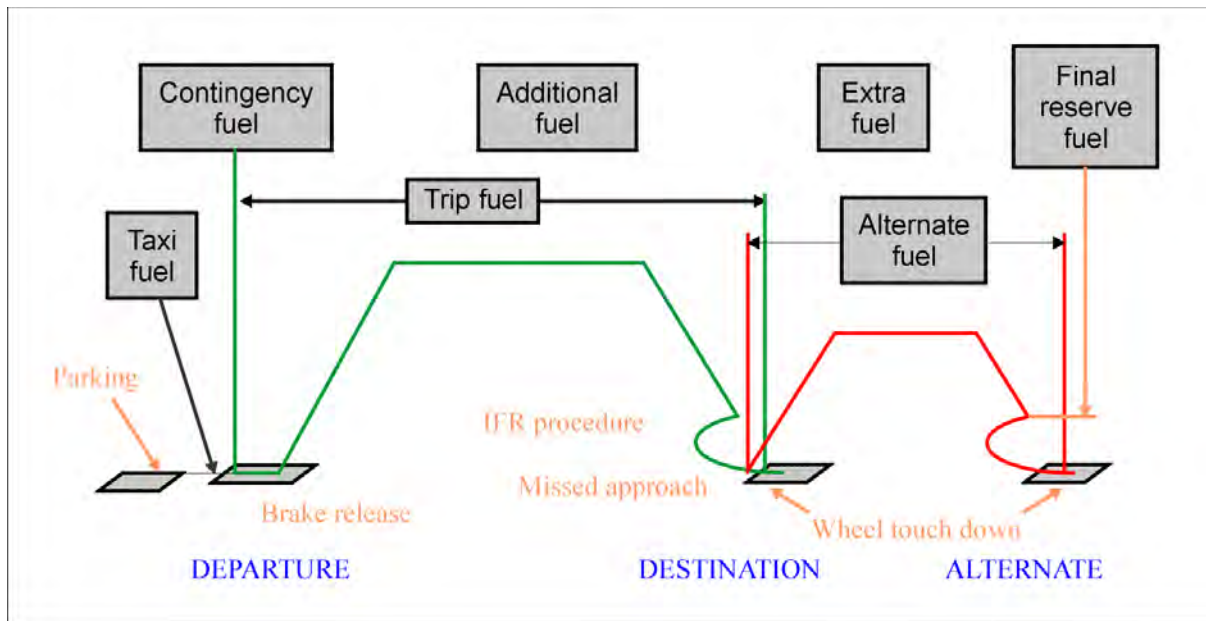

Figure 18: Flag and Supplemental Operation's Fuel Quantities

2.2.2.1. Taxi Fuel

Taxi fuel is the same as in Domestic Operations (see 2.2.1.1)

2.2.2.2. Trip Fuel

Trip fuel is the same as in Domestic Operations (see 2.2.1.2)

2.2.2.3. Contingency Fuel

Contingency fuel is the amount necessary to fly for a period of **10 % of the total required time** from brake release at the departure airport to landing at the destination airport.

2.2.2.4. Alternate Fuel

Alternate fuel is the same as in Domestic Operations (see 2.2.2.4).

2.2.2.5. Final Reserve Fuel

The Final Reserve Fuel is the minimum fuel required to fly for **30 minutes** at 1,500 feet above the alternate airport, or the destination airport, if an alternate is not required, at holding speed in ISA conditions.

2.2.2.6. Additional Fuel

Upon request of the FAA administrator in the interest of safety (Example: Engine failure, pressurization failure, ETOPS).

2.2.3. Isolated Airport Procedure

*FAR 121.645 (c) Subpart U
FAR 121.621 (a)(2) Subpart U*

For such an airport, there is no destination alternate. The regulatory takeoff fuel quantity must include:

- Taxi fuel
- Trip fuel
- Additional fuel: This quantity must be higher than the quantity necessary for a **two hour flight** at normal cruise consumption.

2.2.4. Unrequired Destination Alternate Airport

A destination alternate airport is not required, if the following conditions are met:

2.2.4.1. Domestic Operations

FAR 121.619 Subpart U

“FAR 121.619

*(a) [...] However, no alternate airport is required if for at least **1 hour before and 1 hour after the estimated time of arrival** at the destination airport the appropriate weather reports or forecasts, or any combination of them, indicate--
(1) **The ceiling will be at least 2,000 feet above the airport elevation;** and
(2) **Visibility will be at least 3 miles¹.**”*

2.2.4.2. Flag Operations

FAR 121.621 Subpart U

“FAR 121.621

*(1) The flight is scheduled for **not more than 6 hours** and, for at least **1 hour before and 1 hour after the estimated time of arrival** at the destination airport, the appropriate weather reports or forecasts, or any combination of them, indicate the ceiling will be:*

- (i) At least **1,500 feet above the lowest circling MDA**, if a circling approach is required and authorized for that airport; or*
- (ii) At least **1,500 feet above the lowest published instrument approach minimum or 2,000 feet above the airport elevation**, whichever is greater; and*

¹ Miles stands for Statute Miles (1 mile = 1,609 m).

(iii) **The visibility at that airport will be at least 3 miles, or 2 miles more than the lowest applicable visibility minimums, whichever is greater, for the instrument approach procedures to be used at the destination airport.**

2.2.5. Redispatch Procedure

This procedure permits aircraft to carry less contingency fuel than in the standard case. This is interesting in case of fuel capacity, or takeoff limitations.

Operators select a point called the decision point along the planned route (Figure I9). At this point, the pilot has two possibilities:

- Reach a suitable proximate diversion airport, taking into account the maximum landing weight limitation.
- Continue the flight to the destination airport, when the remaining fuel is sufficient.

This procedure is interesting for flag and supplemental operations, for which contingency fuel depends on flight time. The FAR regulation states:

“FAR 121.631

(a) A certificate holder may specify any regular, provisional, or refueling airport, authorized for the type of aircraft, as a destination for the purpose of original dispatch or release

(b) No person may allow a flight to continue to an airport to which it has been dispatched or released unless the weather conditions at an alternate airport that was specified in the dispatch or flight release are forecast to be at or above the alternate minimums specified in the operations specifications for that airport at the time the aircraft would arrive at the alternate airport. However, the dispatch or flight release may be amended en route to include any alternate airport that is within the fuel range of the aircraft [...]

(c) No person may change an original destination or alternate airport that is specified in the original dispatch or flight release to another airport while the aircraft is en route unless the other airport is authorized for that type of aircraft and the appropriate requirements [...] are met at the time of redispatch or amendment of the flight release.”

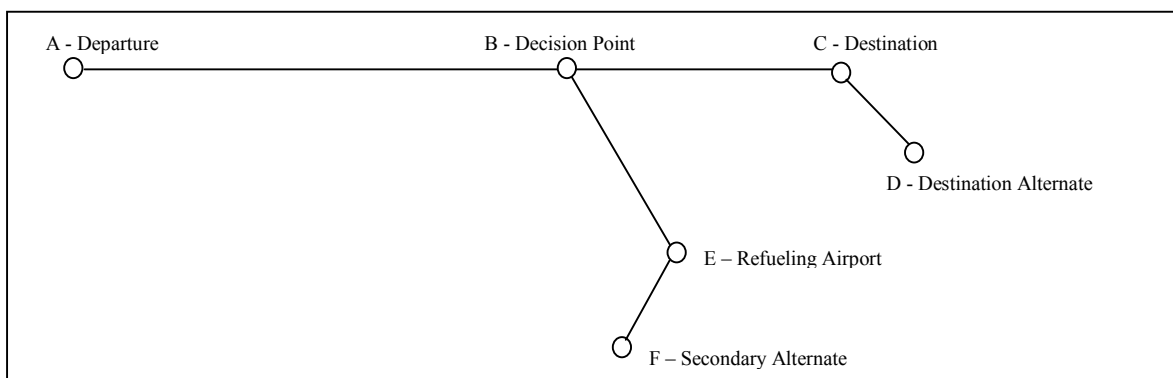

Figure I9: Redispatch Procedure

Using this procedure, the fuel required is the greatest of:

$$F1 = \text{taxi}_A + \text{trip}_{AC} + 10\% \text{ Trip time}_{BC} + \text{alternate}_{CD} + \text{holding}_D + \text{Additional}$$

$$F2 = \text{taxi}_A + \text{trip}_{AE} + 10\% \text{ Trip time}_{AE} + \text{alternate}_{EF} + \text{holding}_F + \text{Additional}$$

When comparing **standard** fuel planning to the **redispatch procedure** fuel planning, the **maximum contingency fuel reduction is 10% of the trip time between A and B.**

$$F1 = \text{taxi}_A + \text{trip}_{AC} + 10\% \text{ Trip time}_{BC} + \text{alternate}_{CD} + \text{holding}_D + \text{Additional}$$

$$\text{STD} = \text{taxi}_A + \text{trip}_{AC} + 10\% \text{ Trip time}_{AC} + \text{alternate}_{CD} + \text{holding}_D + \text{Additional}$$

2.2.6. ETOPS Procedure

*FAR 121.621 Subpart H
AC 120-42A*

Similar to JAR ETOPS Procedure (chapter 1.1.6)

2.2. Fuel Management

FAR 121 does not provide fuel management rules, but the operating manual has to address appropriate procedures. Operators usually adopt the following rules:

2.2.1 Minimum Fuel at Landing Airport

The remaining fuel in flight must be sufficient to proceed to an airport where a safe landing can be made. The **minimum quantity of remaining fuel at landing is defined in the operating manual**, and is usually equivalent to the **final reserve** (fuel quantity necessary to fly for a period of 30 to 45 minutes at 1,500 feet above the airport in ISA conditions at holding speed).

This rule applies to the destination airport, the destination alternate airport, or any en route alternate airport.

J. APPENDIX

1. APPENDIX 1 : ALTIMETRY - TEMPERATURE EFFECT

Here's a concrete example: Consider the case of Switzerland's Sion airport.

During an ILS approach on Runway 26, it is required to overfly given waypoints at given geometrical altitudes, whatever the temperature conditions (Figure J1). For example, at 21 Nm from the glide antenna, the aircraft must be at a height of 8,919 feet above the runway, or at a true altitude of 10,500 feet above mean sea level.

The transition altitude shown on Figure J1 is 16,000 feet, corresponding to a height of 14,419 feet.

Figure J2 provides the indicated altitude values to maintain the required true altitude for different temperature conditions:

When temperature is **ISA - 10**:

- | | | |
|----------------------|-------------|-------------|
| • True altitude | 16,000 feet | 10,500 feet |
| • Indicated altitude | 16,600 feet | 10,900 feet |
| • Δ altitude | 600 feet | 400 feet |

When temperature is **ISA - 20**:

- | | | |
|----------------------|-------------|-------------|
| • True altitude | 16,000 feet | 10,500 feet |
| • Indicated altitude | 17,300 feet | 11,350 feet |
| • Δ altitude | 1,300 feet | 850 feet |

Conclusion:

- **When the temperature moves away from the standard, altimetric error increases.**
- **The altimetric error induced by temperature is proportional to altitude.**

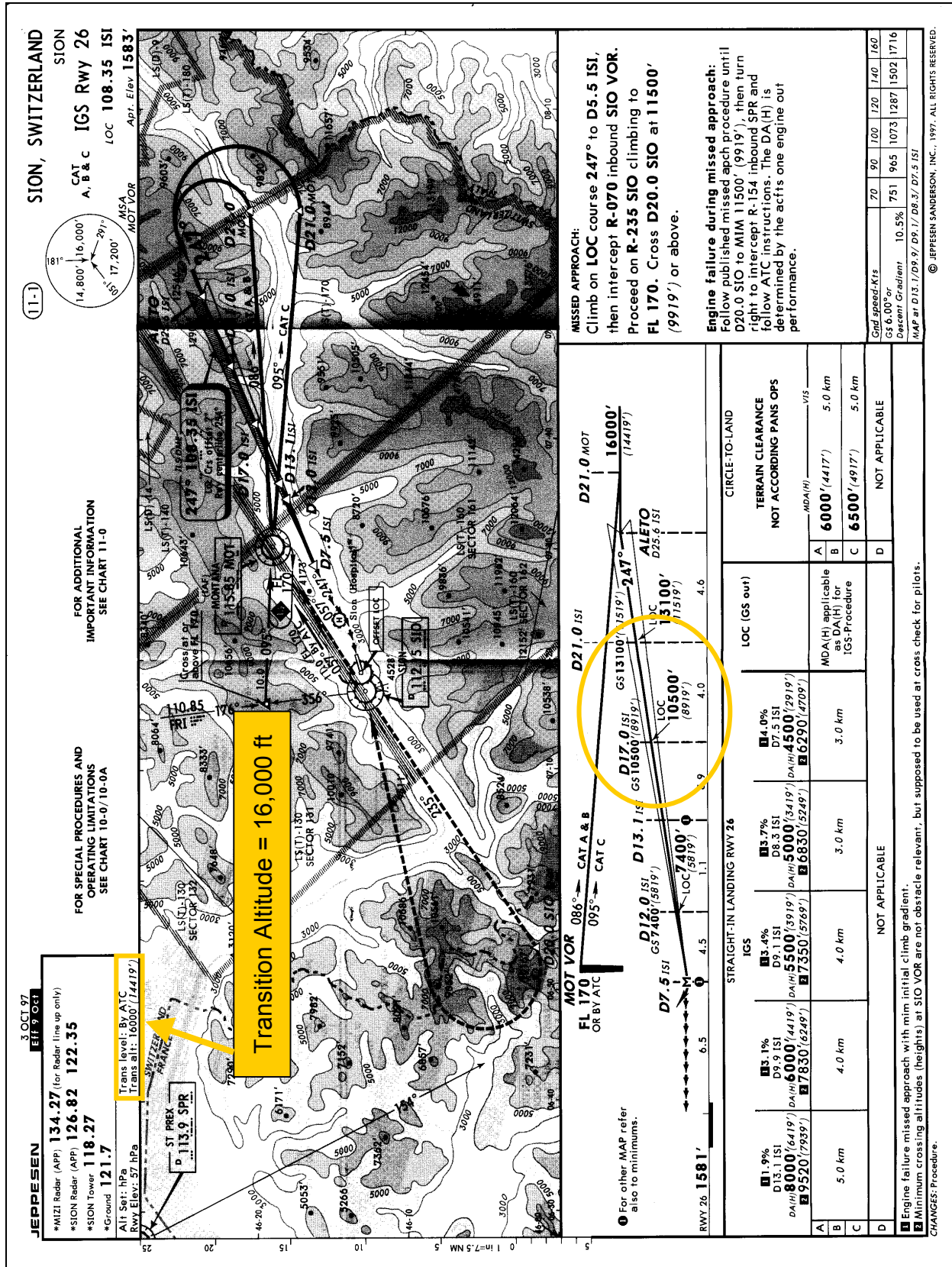

Figure J1: Sion Airport Chart

JEPPESEN 3 OCT 97 **11-0** Eff 9 Oct **SION, SWITZERLAND**
SION

**DESCRIPTION OF
INSTRUMENT GUIDANCE SYSTEM (IGS) RWY 26**

IGS Components

- MOT VORDME as initial approach fix (IAF).
- SIO VORDME for initial line-up.
- ILS (LOC/GS/DME) for final line-up and from ALETO to MAP LOC opening angle: 2°.
- GS PSN: 3.2 NM before LOC-Antenna.

Restrictions

LOC and GS may only be used in the following area: Angle of +/- 8° of approach axis and dist of 31 - 7.5 NM DME LOC during apch. Minimum angle 5°.

Procedure

Due to the limited usable area of the LOC, the initial line-up uses SIO. When inside the usable LOC area, establish on LOC.
IGS procedure may be flown as ILS procedure.
The published altitudes at D21.0 ISI, D17.0 ISI and D12.0 ISI are strictly to be observed.

After reaching DA(H) proceed to rwy maintaining visual ground contact. At DA(H) rwy is still 7 NM ahead and may not yet be in sight. During the visual part use LOC and GS as back-up to D6.0 ISI. Then follow the highway until intercepting rwy 26 axis. Follow the PAPI for final descent segment (3.5°).

The altimeter error may be significant under conditions of extremely cold temperatures. For temperature deviation from ISA use the correction table to read the corrected altitude at the DME fixes.

Table for temperature below ISA

ALT	ISA	ISA +20°	ISA +10°	ISA -10°	ISA -20°
		Altimeter Reading	Altimeter Reading	Altimeter Reading	Altimeter Reading
16000'	-17°	OAT +3° 14920'	OAT -7° 15450'	OAT -27° 16600'	OAT -37° 17300'
13100'	-12°	OAT +8° 12200'	OAT -2° 12650'	OAT -22° 13600'	OAT -32° 14170'
10500'	-6°	OAT +14° 9800'	OAT +4° 10150'	OAT -16° 10900'	OAT -26° 11350'
7400'	0°	OAT +20° 6920'	OAT +10° 7180'	OAT -10° 7670'	OAT -20° 7950'
6000'	+3°	OAT +23° 5650'	OAT +13° 5820'	OAT -7° 6210'	OAT -17° 6450'

CHANGES: New chart. © JEPPESEN SANDERSON, INC., 1997. ALL RIGHTS RESERVED.

Figure J2: Temperature Effect on Indicated Altitude

2. APPENDIX 2 : TAKEOFF OPTIMIZATION PRINCIPLE

This section is specifically designed to explain the takeoff optimization principle. The optimization objective is to obtain the highest possible performance-limited takeoff weight, while fulfilling all airworthiness requirements.

For that purpose, it is necessary to determine what parameters influence takeoff performance and offer a freedom of choice. For instance, the Outside Air Temperature is a parameter which influences takeoff performance, but which cannot be chosen. This is a sustained parameter.

The following table gives an exhaustive list of parameters which influence takeoff performance. The left column shows sustained parameters, while the right one indicates parameters for which a choice is possible (free parameters).

Sustained parameters	Free parameters
Runway Clearway Stopway Elevation Slope Obstacles Temperature Pressure Wind Runway condition Anti-ice Aircraft status (MEL/CDL)	Takeoff configuration Air conditioning V ₁ V ₂

Table J3: Influent Takeoff Parameters

2.1. Takeoff Configuration

Takeoff can be accomplished with one of the following three possible takeoff configurations: Conf 1+F, Conf 2 or Conf 3, on fly-by-wire aircraft.

Each configuration is associated with a set of certified performance and it is, therefore, always possible to determine a Maximum TakeOff Weight (MTOW) for each takeoff configuration. As a result, the **optimum configuration** is the one that provides the **highest MTOW**.

As a general rule, Conf 1+F gives better performance on long runways (better climb gradients), whereas Conf 3 gives better performance on short runways (shorter

takeoff distances). Sometimes, other parameters, such as obstacles, can interfere. In this case, a compromise between climb and runway performance is requested, making Conf 2 the optimum configuration for takeoff.

2.2. Air Conditioning

Air conditioning, when switched on during takeoff, decreases the available power and thus degrades the takeoff performance. It is then advisable to switch it off during takeoff, but this is not always possible as some constraints exist (high air temperature in the cabin or/and company policy), unless APU bleed is used.

2.3. Takeoff Speed Optimization

Takeoff speeds represent the most important source of optimization and MTOW gain. The following section shows how this optimization is achieved thanks to speed ratios (V_1/V_R and V_2/V_S).

2.3.1. Speed Ratios: V_1/V_R and V_2/V_S

2.3.1.1. V_1/V_R Range

The decision speed V_1 must always be less than the rotation speed V_R . But, as V_R depends on weight, the maximum V_1 value is not fixed, whereas the **maximum V_1/V_R ratio is equal to one** (regulatory value).

Moreover, it has been demonstrated that a V_1 speed less than 84% of V_R renders the takeoff distances too long and doesn't, therefore, present any takeoff performance advantages. Consequently, the **minimum V_1/V_R ratio is equal to 0.84** (manufacturer value).

This is why the V_1/V_R ratio is used in the optimization process, since its range is well-identified:

$$0.84 \leq V_1/V_R \leq 1$$

Any V_1/V_R increase (resp. decrease) should be considered to have the same effect on takeoff performance as a V_1 increase (resp. decrease).

2.3.1.2. V_2/V_S Range

The minimum V_2 speed is defined by regulations (Part 25.107):

$$\left. \begin{aligned} V_{2min} &= 1.2 V_S && \text{(A300/A310)} \\ V_{2min} &= 1.13 V_{S1g} && \text{(Fly-By-Wire aircraft)} \end{aligned} \right\} \Rightarrow (V_2/V_S)_{min} = 1.2 \text{ or } 1.13$$

The stall speed depends on weight. So, the minimum V_2 speed is not a fixed value, whereas the minimum V_2/V_S ratio is known for a given aircraft type.

Moreover, a too high V_2 speed requires long takeoff distances and leads to the reduction of climb performance (Figure J4). As it doesn't present any advantage, the V_2/V_S ratio is limited to a maximum value ($(V_2/V_S)_{max}$), which depends on aircraft type:

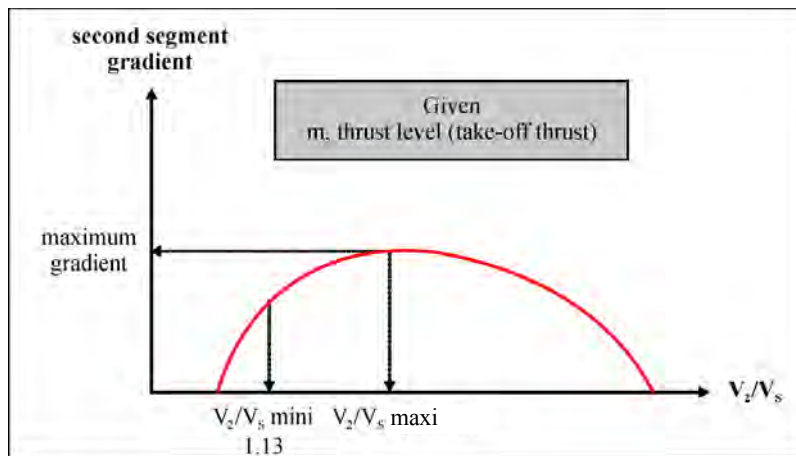

Figure J4 : 2nd Segment Climb Gradient versus V_2/V_S ratio

$$\left. \begin{aligned} V_{2max} &= 1.35 V_S && \text{(A300/A310)} \\ V_{2max} &= 1.35 V_{S1g} && \text{(A320 family)} \\ V_{2max} &= 1.40 V_{S1g} && \text{(A330)} \\ V_{2max} &= 1.50 V_{S1g} && \text{(A340)} \end{aligned} \right\} \Rightarrow (V_2/V_S)_{max} = 1.35 \text{ or } 1.4 \text{ or } 1.5$$

The V_2/V_S ratio is used in the optimization process, since its range is well-identified:

$$(V_2/V_S)_{min} \leq V_2/V_S \leq (V_2/V_S)_{Max}$$

Any V_2/V_S increase (resp. decrease) should be considered to have the same effect on takeoff performance as a V_2 increase (resp. decrease).

2.3.2. V_1/V_R Ratio Influence

The purpose of this paragraph is to study the influence of V_1/V_R ratio variations on takeoff performance, while the V_2/V_S ratio remains constant. For that purpose, it is assumed that the following parameters are fixed:

Fixed parameters	
Runway data	Elevation Runway Clearway Stopway Slope Obstacles
Outside conditions	QNH Outside Air Temperature Wind component
Aircraft data	Flaps/Slats Air conditioning Anti-ice Aircraft status (MEL/CDL) V₂/V_S

2.3.2.1. Runway Limitations

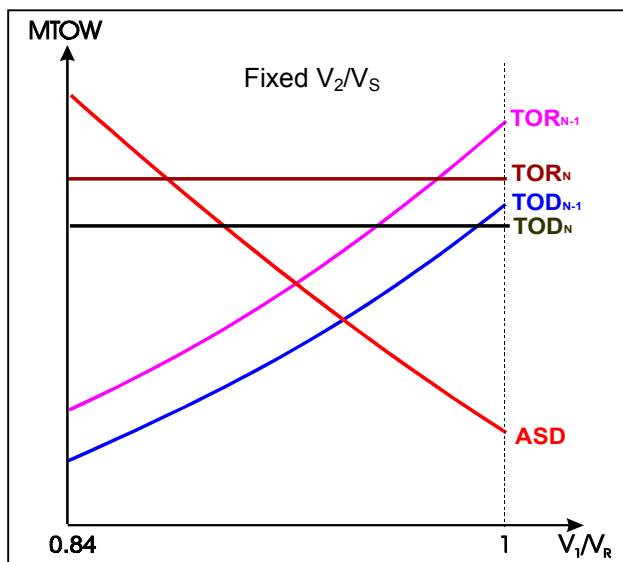

As seen in the takeoff section of this brochure, any V_1/V_R increase leads to (Figure J5):

- An increase in MTOW limited by:
 - TOD_{N-1}
 - TOR_{N-1}
- A decrease in MTOW limited by:
 - ASD_(N or N-1)
- Not influencing the MTOW limited by:
 - TOD_N
 - TOR_N

Figure J5 : Runway Limited MTOW

2.3.2.2. Climb and Obstacle Limitations

The V_1 speed (decision speed on ground) has no influence on climb gradients (first, second and final takeoff segments).

On the contrary, the obstacle-limited weight is improved with a higher V_1 , as the takeoff distance is reduced. Therefore, the start of the takeoff flight path is obtained at a shorter distance, requiring a lower gradient to clear the obstacles.

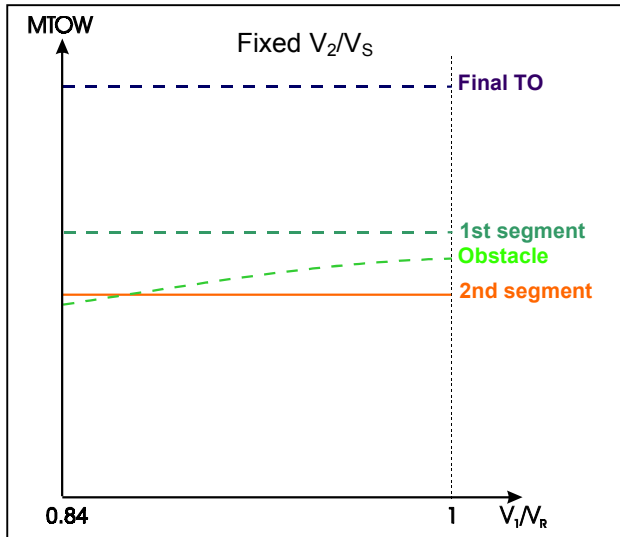

Figure J6 : Climb and Obstacle Limited MTOW

Any V_1/V_R increase leads to (Figure J6):

- An increase in MTOW limited by:
 - Obstacles
- Not influencing the MTOW limited by the:
 - First segment
 - Second segment
 - Final takeoff segment

2.3.2.3. Brake Energy and Tire Speed Limitations

A maximum V_1 speed, limited by brake energy (V_{MBE}), exists for each TOW. To achieve a higher V_1 speed, it is necessary to reduce TOW.

On the contrary, the decision speed doesn't influence the tire speed limit.

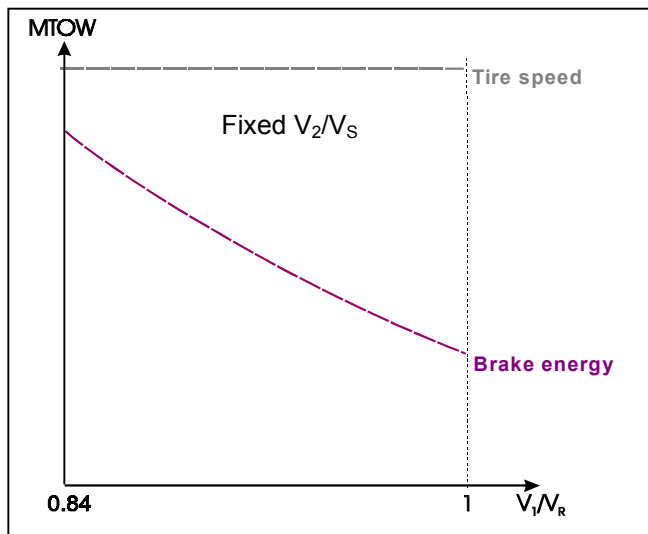

Figure J7 : Brake Energy and Tire Speed Limited MTOW

Any V_1/V_R increase leads to (Figure J7):

- A decrease in MTOW limited by:
 - Brake energy
- Not influencing the MTOW limited by the:
 - Tire speed

2.3.2.4. All limitations

The following Figure (J8) shows that the highest of the maximum takeoff weights can be achieved at a given optimum V_1/V_R ratio. This optimum point corresponds to the intersection between two limitation curves.

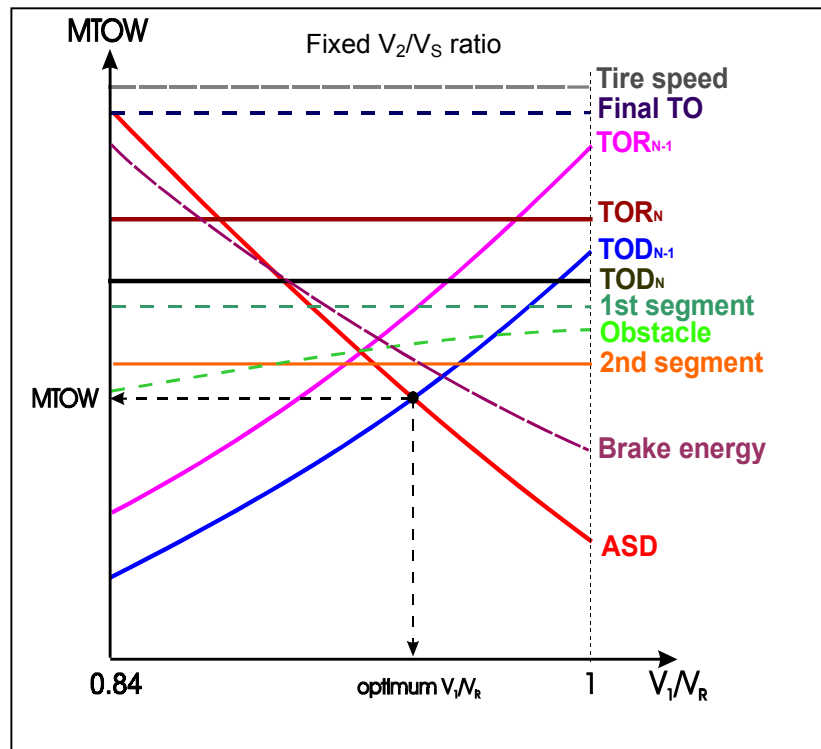

Figure J8 : Optimum MTOW

The result of this optimization process is, for a given V_2/V_S ratio, an optimum **MTOW** and an associated optimum V_1/V_R ratio.

2.3.3. V_2/V_S Ratio Influence

The purpose of this paragraph is to study the influence of V_2/V_S ratio variations on takeoff performance, for a given V_1/V_R ratio.

2.3.3.1. Runway Limitations

As a general rule, for a given V_1/V_R ratio, any increase in the V_2/V_S ratio leads to an increase in the one-engine-out and the all-engine takeoff distances. Indeed, it is necessary to acquire more energy on the runway, in order to achieve a higher V_2 speed at 35 feet. As a result, the acceleration phase is longer.

On the contrary, V_2 speed has no direct impact on the ASD. But a higher V_2 speed results in a higher V_R speed and, therefore, for a given V_1/V_R ratio, in a higher V_1 speed. Hence, the effect on ASD.

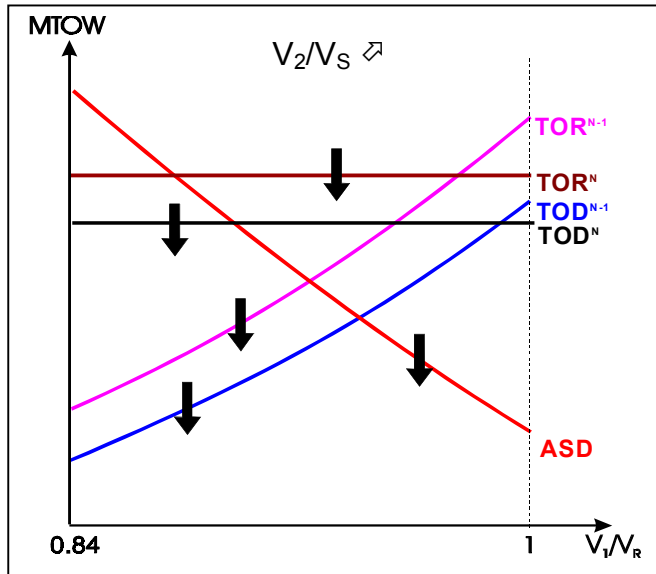

Any V_2/V_S increase leads to (Figure J9):

- A decrease in MTOW limited by:
 - TOD_{N-1} and TOD_N
 - TOR_{N-1} and TOR_N
 - ASD_{N-1} and ASD_N

Figure J9 : V_2/V_S Effect on the Runway Limitations

2.3.3.2. Climb and Obstacle Limitations

As shown in Figure J4, any V_2/V_S increase results in better climb gradients (1st and 2nd segment) and, therefore, in better climb limited MTOWs (1st segment, 2nd segment, obstacle).

On the other hand, as the final takeoff segment is flown at green dot speed, it is not influenced by V_2 speed variations.

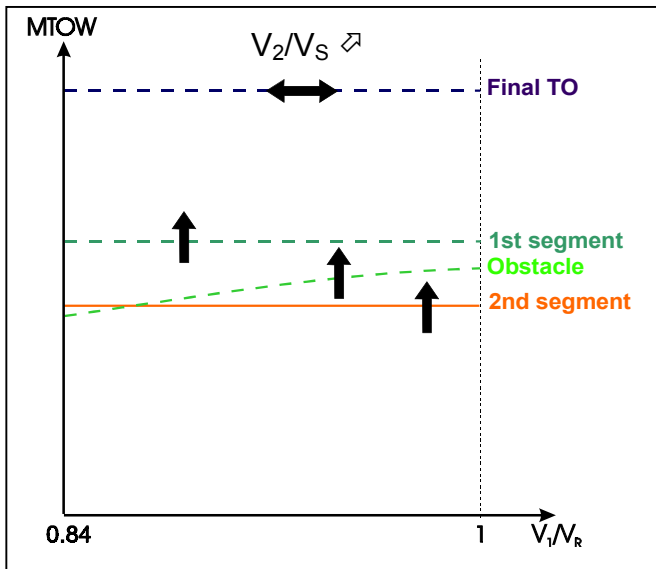

Any V_2/V_S increase leads to (Figure J10):

- An increase in MTOW limited by the:
 - First segment
 - Second segment
 - Obstacles
- Not influencing the MTOW limited by the:
 - Final takeoff segment

Figure J10 : V_2/V_S Effect on Climb and Obstacle Limitations

2.3.3.3. Brake Energy and Tire Speed Limitations

V_2 speed does not directly impact brake energy limitation. Nevertheless, any V_2 increase results in a V_R increase and, therefore, in a V_1 increase, at a fixed V_1/V_R ratio. Hence, the effect on brake energy limited weight.

The lift-off speed, V_{LOF} , is limited by the tire speed (V_{tire}). As a result, V_2 is limited to a maximum value. Any V_2/V_S increase is then equivalent to a V_S reduction, since V_2 is assumed to be fixed, and thus the tire speed limited takeoff weight is reduced.

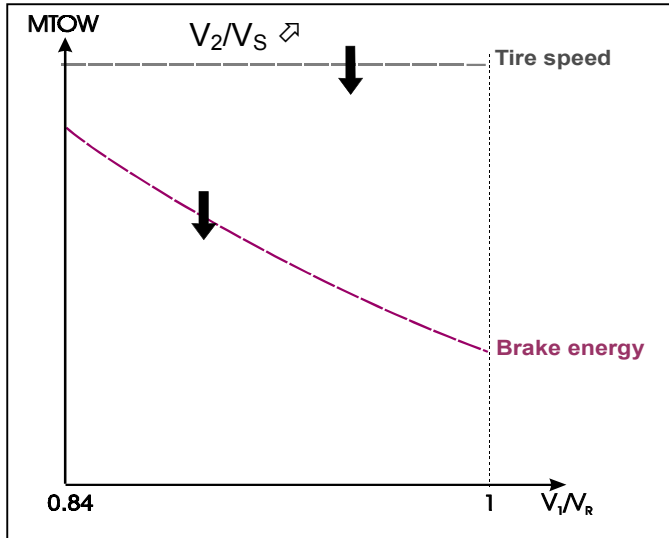

Any V_2/V_S increase leads to (Figure J11):

- A decrease in MTOW limited by the:
 - Brake energy
 - Tire speed

Figure J11 : V_2/V_S Effect on Brake Energy and Tire Speed Limitations

2.4. Result of the Optimization Process

2.4.1. Maximum Takeoff Weight

The previous section shows how, for a given V_2/V_S ratio, it is possible to find an optimum MTOW and its associated optimum V_1/V_R ratio.

For each V_2/V_S ratio comprised between V_2/V_{Smin} and V_2/V_{Smax} , such a determination is carried out. In the end, the highest of all the optimum MTOWs and associated optimum V_1/V_R is retained. It therefore corresponds to an optimum V_2/V_S ratio. The result of the optimization process is, for a given runway and given takeoff conditions:

Result of the optimization process

- The highest possible MTOW
- The optimum V_1/V_R ratio
- The optimum V_2/V_S ratio

2.4.2. Takeoff Speeds

The optimization process indicates that MTOW can only be taken off with a single set of takeoff speeds (V_1 , V_R and V_2). The use of different speeds would result in an MTOW reduction.

Once the optimum speed ratios (V_1/V_R and V_2/V_S) are obtained, the takeoff speeds are obtained as follows:

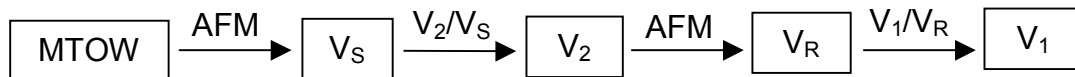

Note: AFM means that the information is obtained from the Aircraft Flight Manual.

2.4.3. Limitation Codes

The nature of the takeoff weight limitation is always indicated in the takeoff charts (RTOW charts). For that purpose, different codes are necessary (Table J12) which depend on the software used for the computation: **TLC or OCTOPUS**. For more details on this software, refer to the **appendix 3** of this manual (“Takeoff performance software”).

LIMITATIONS CODES			
TLC codes A300/A310/A320		OCTOPUS codes A318/A319/A320/A321/A330/A340	
<u>Codes</u>	<u>Nature</u>	<u>Codes</u>	<u>Nature</u>
1	Structural weight	1	1 st segment
2	1 st or 2 nd segment	2	2 nd segment
3	Runway (OEI) ¹	3	Runway (OEI and AEO)
4	Obstacle	4	Obstacle
5	Tire speed	5	Tire speed
6	Brake energy	6	Brake energy
7	Runway (AEO) ²	7	Structural weight
8	Final takeoff	8	Final takeoff
		9	VMU

Table J12 : Takeoff Chart Limitation Codes

Most of the time, MTOW is obtained at the intersection of two limitation curves (Figure J13). This is why the limitation codes are always indicated with two digits in a RTOW chart.

¹ OEI = One Engine Inoperative

² AEO = All Engines operative

2.4.3.1. MTOW limited by two limitations

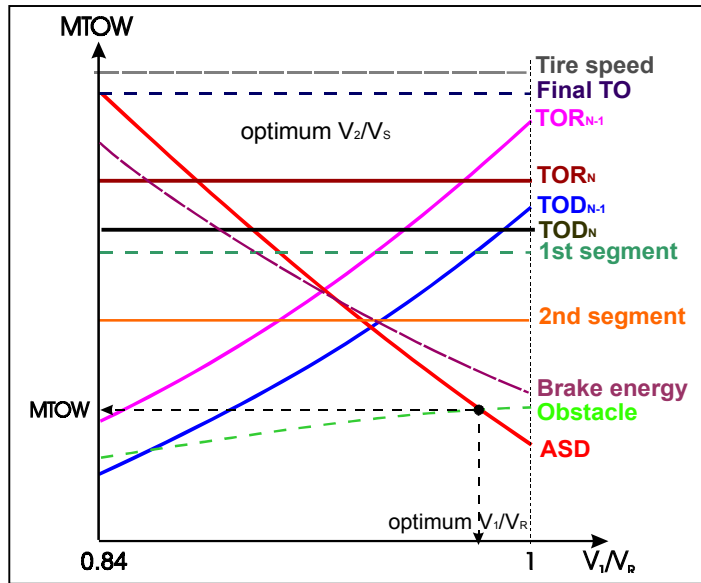

Figure J13 : Double Limitation Case

In Figure J13, takeoff weight is limited by obstacles and by the Accelerate Stop Distance (ASD).

An **RTOW chart** would indicate Limitation **Code 4/3**.

2.4.3.2. MTOW limited by one limitation

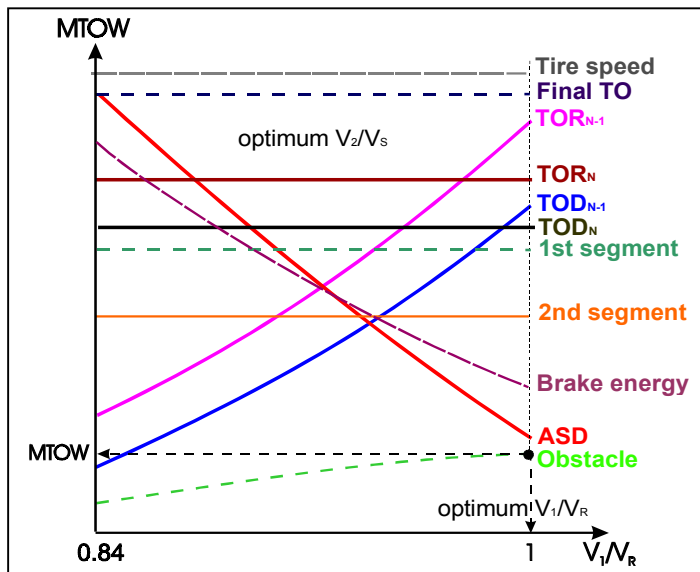

Figure J14 : Single Limitation Case

In Figure J14, takeoff weight is only limited by obstacles.

An **RTOW chart** would indicate Limitation **Code 4/4**.

2.4.3.3. MTOW limited by three limitations

In this particular case, a V_1 range exists. As a result, whatever the selected V_1 speed between a minimum V_1 and a maximum V_1 , the MTOW remains the same while the nature of the limitation changes. In this case, the effective takeoff V_1 speed remains at the operator's discretion.

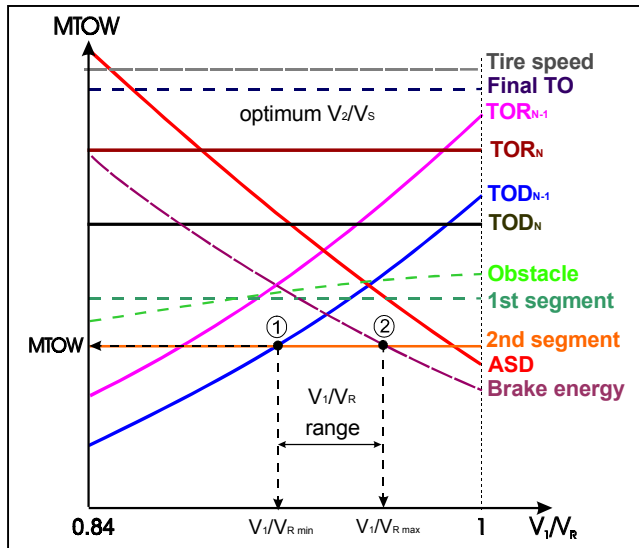

Figure J15 : Triple Limitation Case

In Figure J15, the nature of the limitation depends on the V_1/V_R ratio:

At V_1/V_{Rmin} (Point 1): The takeoff weight is limited by both the TOD_{N-1} and the 2nd segment (**RTOW Code: 3/2**).

Between V_1/V_{Rmin} and V_1/V_{Rmax} : The takeoff weight is only limited by the 2nd segment (**RTOW Code: 2/2**).

At V_1/V_{Rmax} (Point 2): The takeoff weight is limited by the 2nd segment and the brake energy (**RTOW Code: 2/6**).

2.4.4. RTOW Chart Information

A319131 - JAA		IAE V2522-A5 engines		PARIS - (ORLY)		08		17.00 30-AUG-00	
QNH 1013.25 HPA		Elevation 277 FT		TORA 3320 M		4 obstacles		AD131A04 *V.9	
Air cond. Off		Isa temp 14 C		TODA 3320 M				DRY	
Anti-icing Off		rwy slope 0.07%		ASDA 3320 M					
OAT		CONF 1+F							
C	TAILWIND -10 KT	TAILWIND -5 KT	WIND 0 KT	HEADWIND 10 KT	HEADWIND 20 KT				
	72.0 4/4 146/46/51	73.4 2/4 148/48/53	74.8 2/4 153/53/58	75.6 2/4 157/57/62	76.3 2/4 161/61/65				
4	71.6 4/4 146/46/51	73.0 4/4 147/47/52	74.4 2/4 152/52/57	75.2 2/4 156/56/60	75.9 2/4 159/59/64				
14	71.2 4/4 145/45/50	72.5 4/4 146/46/51	74.0 2/4 150/50/55	74.9 2/4 154/54/59	75.6 2/4 157/57/62				
24	71.0 4/4 149/49/54	72.1 4/4 145/45/50	73.6 2/4 149/49/53	74.5 2/4 152/52/57	75.2 2/4 156/56/61				
34	70.8 4/4 148/48/53	71.7 4/4 145/45/50	73.1 2/4 147/47/52	74.1 2/4 151/51/56	74.9 2/4 154/54/59				
44	70.5 4/4 148/48/52	71.7 4/4 150/50/55	72.7 2/4 146/46/51	73.7 2/4 149/49/54	74.5 2/4 153/53/57				
54	70.4 4/4 147/47/51	71.5 4/4 149/49/54	72.0 2/4 142/43/48	72.1 4/8 144/49/54	72.0 2/4 136/43/48				
56	69.5 4/4 146/46/51	70.6 4/4 148/48/53	71.3 2/4 142/43/48	71.4 4/8 146/49/54	71.3 2/4 136/43/48				
58	68.3 4/4 145/45/50	69.4 4/4 147/47/52	70.4 4/4 144/44/48	71.4 2/4 147/47/51	71.6 2/4 146/47/52				
60	67.2 4/4 144/44/49	68.2 4/4 146/46/50	69.3 2/4 143/43/47	70.2 2/4 146/46/50	71.0 2/4 149/49/54				
62	66.0 4/4 142/42/47	67.0 4/4 145/45/49	68.2 2/4 141/41/46	69.1 2/4 145/45/49	69.8 2/4 148/48/53				
64	64.8 4/4 141/41/46	65.7 4/4 139/39/43	67.0 2/4 140/40/45	67.9 2/4 144/44/48	68.6 2/4 147/47/51				
66	63.6 4/4 140/40/44	64.6 4/4 138/38/42	65.9 2/4 140/40/44	66.7 2/4 143/43/47	67.4 2/4 146/46/50				
68	62.4 4/4 139/39/43	63.4 4/4 137/37/41	64.7 2/4 139/39/43	65.5 2/4 142/42/46	66.1 2/4 145/45/50				
70	61.2 4/4 138/38/42	62.2 4/4 136/36/40	63.4 2/4 138/38/42	64.2 2/4 141/41/45	64.8 2/4 144/44/48				
72	60.0 4/4 137/37/41	61.0 4/4 135/35/39	62.2 2/4 137/37/41	62.9 2/4 140/40/44	63.5 2/4 143/43/47				
74	58.8 4/4 136/36/40	59.8 4/4 134/34/38	60.9 2/4 136/36/40	61.7 2/4 139/39/43	62.2 2/4 142/42/46				
76	57.5 4/4 135/35/40	58.5 4/4 133/33/37	59.7 2/4 135/35/39	60.3 2/4 138/38/42	60.9 2/4 141/41/45				
78	56.1 4/4 129/29/34	57.2 4/4 131/31/35	58.4 2/4 134/34/38	59.0 2/4 137/37/41	59.6 2/4 140/40/44				
79	55.5 4/4 130/30/34	56.6 4/4 130/30/35	57.7 2/4 134/34/38	58.4 2/4 137/37/41	58.9 2/4 140/40/44				

In each RTOW chart box (Figure J16), the following information is provided for a given wind component, and a given outside air temperature:

MTOW limit code
 $V_1/V_R/V_2$

The indicated values are the result of the above optimization process.

In case of a V_1 range, the nature of the V_1 speed (V_{1min} , V_{1mean} or V_{1max}) indicated in the chart is displayed at the bottom of the chart:

MTOW (1000 kg) codes
 $V_{1min}/V_R/V_2$ (kt)

Figure J16 : A319 RTOW chart example

3. APPENDIX 3 : TAKEOFF PERFORMANCE SOFTWARE

3.1. P.E.P for Windows

3.1.1. What is P.E.P. ?

The PEP (Performance Engineering Programs) for a Windows' environment is designed to provide the necessary tools not only to handle the performance aspects of flight preparation, but also to monitor aircraft performance after the flight. It is dedicated to airline Flight operations and design offices. Based on the Microsoft Windows © operating system, PEP for Windows is a standalone application which offers access to all the Airbus aircraft performance programs in a user-friendly and customizable environment.

The following is a list of the available performance programs:

- **FM** : Aircraft Flight Manual (certified performance data)
- **TLO** : TakeOff and Landing computation (MTOW, MLW, speeds)
- **OFP** : Operational Flight Path computation (takeoff and approach paths)
- **NLC** : Noise Level Computation program (takeoff and approach noise)
- **IFP** : In Flight Performance program (climb, cruise, descent, holding...)
- **APM** : Aircraft Performance Monitoring (aircraft performance level)
- **FLIP** : Computerized Flight Planning (fuel calculation)

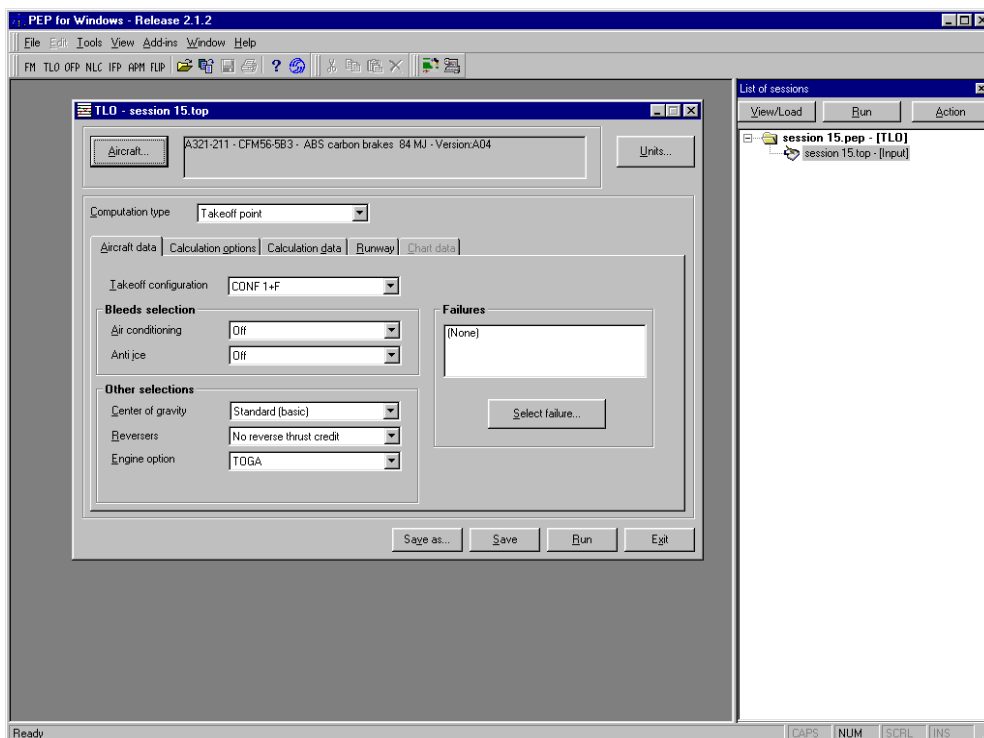

Figure J17 : PEP for Windows Software

3.1.2. TLO Module

The PEP module, dedicated to takeoff performance computation and takeoff chart (RTOW) production, is called **TLO** (Takeoff and Landing Optimization).

TLO is an interface common to all aircraft types, which facilitates the management of takeoff input and output data. On the other hand, the calculation program used for the performance determination depends on the aircraft type. It is called:

- **TLC** (or TCP) for A300, A310 and A320¹
- **OCTOPUS** for A318, A319, A320, A321, A330 and A340

Therefore, as two different calculation programs exist, different RTOW formats are obtained (see Figures J18 and J19).

Figure J18 : TLC takeoff chart example

Figure J19 : OCTOPUS takeoff chart example

3.1.2.1. TLC program

The first optimization tool, developed by an aircraft manufacturer in the early 1980's, was the Airbus TLC (Takeoff and Landing Computation) program based on tabulated data of the AFM. During optimization, the TLC interpolates the different

¹ some A320 models are certified with TLC, others with OCTOPUS.

limitations in tables and returns the MTOW and associated speeds. The TLO performance database is a “picture” of the performance charts, that were used in conventional paper flight manuals. The TLC has been designed to replace the long and tedious calculation process that was done manually, based on tables and graphs. It was also designed to facilitate Airline Flight Operations’ work by reducing the production time and the risk of errors.

3.1.2.2. OCTOPUS program

The next step in the performance calculation process, referred to as OCTOPUS (Operational and Certified Takeoff and landing Universal Software), not only offers the same advantages as TLC but also drastically changes the performance calculation method. It is no longer based on pre-computed data, but uses the “first principle” mode that allows a real on-time computation to benefit from a higher takeoff weight. Instead of smoothed pre-computed performance results, the OCTOPUS performance database contains all the airplane and engine characteristics, enabling performance computation based on physics equations. In addition, OCTOPUS introduces a new and improved takeoff chart format, with its use of multi-configurations and influences.

3.2. Less Paper Cockpit (LPC)

This new concept based on **onboard computations, using a laptop in the cockpit**, represents the ultimate performance computation method. This program, which replaces paper charts, **reduces flight preparation time and the risk of error**. It suppresses the interpolations and method errors, while providing quick results for real external conditions. As a result, the performance obtained (MTOW or flexible temperature) is the best possible one, thus leading to **improved profit**.

The computation is based on the same performance software as TLO (i.e. TLC, or OCTOPUS depending on the aircraft type: Figure J20).

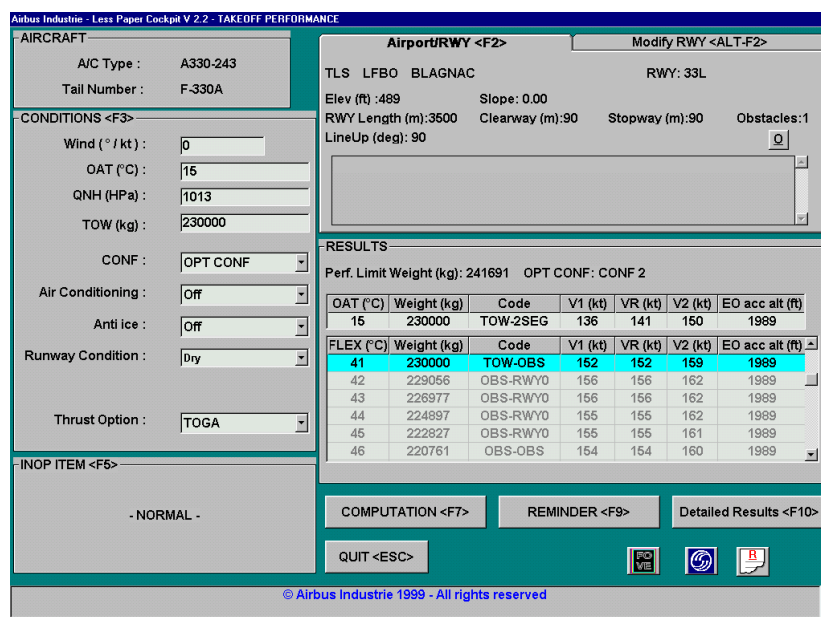

Figure J20: LPC Takeoff Interface

4. APPENDIX 4 : ABBREVIATIONS

Greek letters

α	(alpha)	Angle of attack
γ	(gamma)	Climb or descent angle
δ	(delta)	Pressure ratio = P / P_0
Δ	(DELTA)	Parameters' variation (ex : Δ ISA, Δ P)
ϕ	(phi)	Bank angle
μ	(mu)	Runway friction coefficient
θ	(theta)	Aircraft attitude
ρ	(rho)	Air density
ρ_0	(rho zero)	Air density at Mean Sea Level
σ	(sigma)	Air density ratio = ρ / ρ_0

A

a	Sound velocity
A_0	Sound velocity at sea level
AC	Advisory Circular (FAA)
ACJ	Advisory Circular Joint (JAA)
ADIRS	Air Data / Inertial Reference System
AFM	Aircraft Flight Manual
ALD	Actual Landing Distance
AMC	Acceptable Means of Compliance (JAA)
AMJ	Advisory Material Joint (JAA)
AOM	Airline Operation Manual
APM	Aircraft Performance Monitoring (program)
ASD	Accelerate-Stop Distance
ASDA	Accelerate-Stop Distance Available
ATC	Air Traffic Control

C

C_D	Drag coefficient
C_L	Lift coefficient
CAS	Calibrated Air Speed
CDL	Configuration Deviation List
CG	Center of gravity
CI	Cost Index
CL	Climb throttle position
CWY	Clearway

D

DA	Drift Angle
DGAC	Direction Générale de l'Aviation Civile
DOC	Direct Operating Cost
DOW	Dry operating weight

E

ECON	Economic (minimum cost) speed
EGT	Exhaust Gas Temperature
EOSID	Engine Out Standard Instrument Departure
EPR	Engine Pressure Ratio
ETOPS	Extended range with Twin engine aircraft OPerationS

F

f()	Function of ()
FAA	Federal Aviation Administration
FAR	Federal Aviation Regulation
FBW	Fly-By-Wire (aircraft)
FCOM	Flight Crew Operating Manual
FF	Fuel Flow (hourly consumption)
FL	Flight Level
FLIP	Flight Planning (program)
FMGS	Flight Management and Guidance System

G

g	Gravitational acceleration
GAL	US gallon
GD	Green Dot speed
GS	Ground Speed

H

hPa	hecto Pascal
------------	---------------------

I

IA	Indicated Altitude
IAS	Indicated Air Speed
ICAO	International Civil Aviation Organization
IEM	Interpretative / Explanatory material (JAA)
IFP	In Flight Performance (program)
IFR	Instrument Flight Rules
IL	Information Leaflet (JAA)
IMC	Instrument Meteorological Conditions
in Hg	Inches of mercury
ISA	International Standard Atmosphere

J

JAA	Joint Aviation Authority
JAR	Joint Airworthiness Requirements

K

Ki	Instrumental correction (Antenna error)
-----------	--

L

LDA	Landing Distance Available
LPC	Less Paper Cockpit (program)
LRC	Long Range Cruise speed
LW	Landing Weight

M

m	Aircraft's mass
M	Mach number
M _{LR}	Mach of Long Range
M _{MR}	Mach of Maximum Range
M _{MO}	Maximum Operating Mach number
MCDU	Multipurpose Control and Display Unit
MCT	Maximum Continuous Thrust
MEA	Minimum safe En route Altitude
MEL	Minimum Equipment List
MEW	Manufacturer Empty Weight
MGA	Minimum safe Grid Altitude
MLW	Maximum Landing Weight
MOCA	Minimum Obstacle Clearance Altitude
MORA	Minimum Off Route Altitude
MSL	Mean Sea Level
MTOW	Maximum TakeOff Weight
MTW	Maximum Taxi Weight
MZFW	Maximum Zero Fuel Weight

N

n	Load factor
n _z	Load factor component normal to the aircraft's longitudinal axis
N	All engines operating
N1	Speed rotation of the fan
N-1	One engine inoperative
N-2	Two engines inoperative
NLC	Noise Level Computation (program)
NPA	Notice for Proposed Amendment (JAA)
NPRM	Notice for Proposed Rule Making (FAA)

O

OAT	Outside Air Temperature
OCTOPUS	Operational and Certified Takeoff and landing Universal Software
OEW	Operational Empty Weight
OFF	Operational Flight Path (program)

P

P	Pressure
P ₀	Standard pressure at Mean Sea Level
P _{amb}	Ambient pressure at the flight altitude
P _{force}	Force power

P_s	Static pressure
P_{set}	Altimeter's reference pressure
P_t	Total pressure
PA	Pressure Altitude
PEP	Performance Engineering Programs
PFD	Primary Flight Display
PNR	Point of No Return
<u>Q</u>	
q	Dynamic pressure
QFE	Pressure at the airport reference point
QNH	Mean Sea Level pressure
QRH	Quick Reference Handbook
<u>R</u>	
R	Universal gas constant
RC	Rate of Climb
RD	Rate of Descent
RLD	Required Landing Distance
RTOW	Regulatory TakeOff Weight chart
<u>S</u>	
S	Wing area
SAT	Static Air Temperature
SFC	Specific Fuel Consumption
SID	Standard Instrument Departure procedure
SR	Specific Range
STAR	STandard ARrival procedure
STD	Standard
SWY	Stopway
<u>T</u>	
T	Temperature
T_0	Standard temperature at Mean Seal Level
T_{ISA}	Standard temperature
T_{REF}	Flat Rating Temperature
T/C	Top of Climb
T/D	Top of Descent
TA	True Altitude
TAS	True Air Speed
TAT	Total Air Temperature
TLC	Takeoff and Landing Computation (program)
TLO	TakeOff and Landing Optimization (program)
TO	TakeOff
TOD	TakeOff Distance
TODA	TakeOff Distance Available
TOR	TakeOff Run
TORA	TakeOff Run Available

TOGA	TakeOff / Go-Around thrust
TOW	TakeOff Weight
<u>V</u>	
<u>V</u>	Velocity
V₁	Takeoff decision speed
V₂	Takeoff climb speed
V_{APP}	Final approach speed
V_{EF}	Engine failure speed
V_{FE}	Maximum flap extended speed
V_{LE}	Landing gear extended speed
V_{LO}	Landing gear operating speed
V_{LOF}	Lift Off speed
V_{LS}	Lowest selectable speed
V_{MBE}	Maximum brake energy speed
V_{MCA}	Minimum control speed in the air
V_{MCG}	Minimum control speed on ground
V_{MCL}	Minimum control speed during approach and landing
V_{MCL-2}	V_{MCL} two engines inoperative
V_{MO}	Maximum Operating speed
V_{MU}	Minimum Unstick speed
V_R	Rotation speed
V_{REF}	Reference landing speed
V_S	Stalling speed
V_{S1G}	Stalling speed at one g
V_{SR}	Reference stalling speed
V_{tire}	Maximum tire speed
VFR	Visual Flight Rules
VMC	Visual Meteorological Conditions
<u>W</u>	
<u>W</u>	Weight
Wa	Apparent weight
WC	Wind component



AIRBUS

AIRBUS S.A.S.
31707 BLAGNAC CEDEX - FRANCE
CONCEPT DESIGN SCM12
REFERENCE SCM-A226
JANUARY 2002
PRINTED IN FRANCE
© AIRBUS S.A.S. 2002
ALL RIGHTS RESERVED

AN EADS JOINT COMPANY
WITH BAE SYSTEMS

The statements made herein do not constitute an offer. They are based on the assumptions shown and are expressed in good faith. Where the supporting grounds for these statements are not shown, the Company will be pleased to explain the basis thereof. This document is the property of Airbus and is supplied on the express condition that it is to be treated as confidential. No use of reproduction may be made thereof other than that expressly authorised.